

2021

2021

2021

2021



Virginia Construction Code

Virginia Regulations

Virginia Energy Conservation Code

Virginia Fuel Gas Code



Virginia Residential Code



Virginia Statewide Fire Prevention Code



Virginia Existing Building Code



Electrical Code

2020



2021 Code Change Training Series

Companion Guide

2nd Edition















2021



Table of Contents

Welcome.....	4
About this Guide.....	5
2021 Code Change Update Training Matrix.....	6
Quick Reference Guide.....	9
Code Change Tracker Checklist.....	10

2021 Significant Code Changes

 Administrative and Related Codes(USBC, IBSR, VADR).....	27
 Elevator (2021 VCC).....	30
 Maintenance (2021 VPMC)	31
 Fire Prevention (2021 SFPC).....	37
 Pools and Spas (2021 ISPSC).....	43
 Residential Building (2021 VRC).....	62
 Commercial Building (2021 VCC).....	154
 Commercial Energy (2021 VECC[C]).....	228
 Existing Building (2021 VEBC).....	240
 Electrical (2020 NEC & 2021 USBC).....	243
 Plumbing (2021 IPC & 2021 USBC).....	328
 Mechanical(2021 IMC & 2021 USBC).....	351
 Fuel Gas (2021 IPC & 2021 USBC).....	375
Glossary.....	386

Welcome!

Welcome to the 2021 Virginia Code Change Update Training series, presented by the Jack A. Proctor Virginia Building Code Academy! This training series is designed to make you, the experienced code official, aware of significant changes to the administrative, building and fire codes as well as all related codes on both the state and national levels.

Code Change Training is mandatory for all Board of Housing and Community Development issued certificate holders, according to the 2021 Code Change Training Requirements for Code Officials.

Through these training modules, we will highlight the most sweeping and significant changes to building codes as they pertain to administration and enforcement in the Commonwealth of Virginia.

This training series and its companion guide are not inclusive of all changes to the codes and standards and are not meant to serve as substitutes for the actual code documents themselves. Certificate holders are encouraged to review the MANY changes that are not included in this series.

Whether you chose classroom learning, online, or both you will find this training companion guide as a useful resource while attending training as well as on the job afterwards.

Thank you for joining us, and we hope you enjoy your training experience!

About This Guide

This guide is designed to make it easy for you to track, note, and follow up on code changes presented in the 2021 Code Change Training series. We hope you will explore the tools and features contained in this guide.

- ❑ This training series and its companion guide are not inclusive of all changes to the codes and are not meant to serve as substitutes for the actual code books. Certificate holders are encouraged to review the changes that may not have been included in this series.
- ❑ **Quick Reference Guide:** Keep track of the courses that you plan to take as well as the dates of those courses, by using this consolidated table.
- ❑ **Code Tracker:** We know that different codes are more important to some people than to others. This section includes a checklist of each code change presented in each training module. Every list is color coded and corresponds to the same section later in this book. Use these checklists to note the code changes most important to you. This way they are all in one place for quick and easy reference!
- ❑ **Course Companion:** This section contains a summary of each code change presented in the 2021 Code Change Training series, and is color coded to match both the corresponding ICC code book cover and Code Tracker section.

Note that code changes specific to the 2021 Virginia Uniform Statewide Building Code will be marked with a yellow Virginia icon:

State Code Change



OR

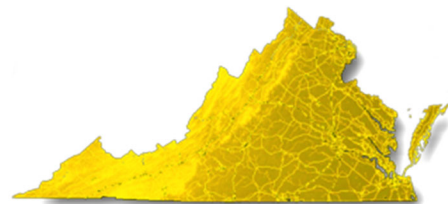

2021 Code Change Training Requirements for Code Officials

2021 Code Change Training (CCT) is offered live via the in-person and virtual classroom as well as self-paced through the VBCA Learning Center (coming in January, 2024). This document lists the mandatory training requirements for all certificate holders based on discipline. For live in person and live virtual course offerings and /or registration, please visit the Online Registration System.

	CERTIFICATION	ADMINISTRATIVE MODULES REQUIRED
All	Required for all certificate holders	<input type="checkbox"/> 2021 CCT – Administrative and Related – includes: IBSR (Industrialized Buildings), ADI (Amusement Device), ISPSC (Pools and Spas), Elevator, SFPC (Statewide Fire Protection), and VPMC (Property Maintenance) <input type="checkbox"/> 2021 CCT – Administrative Refresher
	CERTIFICATION	TECHNICAL MODULES REQUIRED BASED ON CERTIFICATION(S) HELD
Official Roles	Building Official	<input type="checkbox"/> 2021 CCT – ICC A117.1 Accessibility Standard <input type="checkbox"/> 2021 CCT – Virginia Residential Code Module <input type="checkbox"/> 2021 CCT – Commercial Bundle (VBC, VECC, VEBC) <input type="checkbox"/> 2021 CCT – All Trades (Electrical, Plumbing, Mechanical/Fuel Gas)
	Fire Official	NONE (in addition to the two mandatory Administrative courses)
	Property Maintenance Official	NONE (in addition to the two mandatory Administrative courses)
Residential Inspector	Residential Building Inspector	<input type="checkbox"/> 2021 CCT – Virginia Residential Code Module
	Residential Electrical Inspector	<input type="checkbox"/> 2021 CCT – Electrical Module* OR VRC Module
	Residential Mechanical Inspector	<input type="checkbox"/> 2021 CCT – Virginia Mechanical and Fuel Gas Code Module* OR VRC Module
	Residential Plumbing Inspector	<input type="checkbox"/> 2021 CCT – Virginia Plumbing Code Module* OR VRC Module
	Residential Energy Inspector	<input type="checkbox"/> 2021 CCT – Virginia Residential Code Module

	CERTIFICATION	ADMINISTRATIVE MODULES REQUIRED
All	Required for all certificate holders	<input type="checkbox"/> 2021 CCT – Administrative and Related – includes: IBSR (Industrialized Buildings), ADI (Amusement Device), ISPSC (Pools and Spas), Elevator, SFPC (Statewide Fire Protection), and VPMC (Property Maintenance) <input type="checkbox"/> 2021 CCT – Administrative Refresher
	CERTIFICATION	TECHNICAL MODULES REQUIRED BASED ON CERTIFICATION(S) HELD
Commercial Inspector	Commercial Building Inspector	<input type="checkbox"/> 2021 CCT – ICC A117.1 Accessibility Standard <input type="checkbox"/> 2021 CCT – Commercial Bundle (VBC, VECC, VEBC)
	Commercial Electrical Inspector	<input type="checkbox"/> 2021 CCT – Electrical Module*
	Commercial Mechanical Inspector	<input type="checkbox"/> 2021 CCT – Virginia Mechanical and Fuel Gas Code Module*
	Commercial Plumbing Inspector	<input type="checkbox"/> 2021 CCT – ICC A117.1 Accessibility Standard <input type="checkbox"/> 2021 CCT – Virginia Plumbing Code Module*
	Fire Protection Inspector	<input type="checkbox"/> 2021 CCT – Commercial Bundle (VBC, VECC, VEBC)
	Commercial Energy Inspector	<input type="checkbox"/> 2021 CCT – Commercial Bundle (VBC, VECC, VEBC)
Combination	Combination Residential Inspector	<input type="checkbox"/> 2021 CCT – Virginia Residential Code Module
	Combination Commercial Inspector	<input type="checkbox"/> 2021 CCT – ICC A117.1 Accessibility Standard <input type="checkbox"/> 2021 CCT – Commercial Bundle (VBC, VECC, VEBC) <input type="checkbox"/> 2021 CCT – All Trades (Electrical, Plumbing, Mechanical/Fuel Gas)
Inspector - Other	Permit Technician	<input type="checkbox"/> 2021 CCT – Virginia Residential Code Module <input type="checkbox"/> 2021 CCT – Commercial Bundle (VBC, VECC-C, VEBC)
	Fire Prevention Inspector	NONE (in addition to the two mandatory Administrative courses)
	Property Maintenance Inspector	NONE (in addition to the two mandatory Administrative courses)
	Elevator Inspector	NONE (in addition to the two mandatory Administrative courses)
	Amusement Device Inspector	NONE (in addition to the two mandatory Administrative courses)

	CERTIFICATION	ADMINISTRATIVE MODULES REQUIRED
AI	Required for all certificate holders	<input type="checkbox"/> 2021 CCT – Administrative and Related – includes: IBSR (Industrialized Buildings), ADI (Amusement Device), ISPSC (Pools and Spas), Elevator, SFPC (Statewide Fire Protection), and VPMC (Property Maintenance) <input type="checkbox"/> 2021 CCT – Administrative Refresher
	CERTIFICATION	TECHNICAL MODULES REQUIRED BASED ON CERTIFICATION(S) HELD
Plans Examiner	Residential Building Plans Examiner	<input type="checkbox"/> 2021 CCT – Virginia Residential Code Module
	Residential Energy Plans Examiner	<input type="checkbox"/> 2021 CCT – Virginia Residential Code Module
	Commercial Building Plans Examiner	<input type="checkbox"/> 2021 CCT – ICC A117.1 Accessibility Standard <input type="checkbox"/> 2021 CCT – Commercial Bundle (VBC, VECC, VEBC)
	Commercial Energy Plans Examiner	<input type="checkbox"/> 2021 CCT – Commercial Bundle (VBC, VECC, VEBC)
	Combination Building Plans Examiner	<input type="checkbox"/> 2021 CCT – Virginia Residential Code <input type="checkbox"/> 2021 CCT – Commercial Bundle (VBC, VECC, VEBC) <input type="checkbox"/> 2021 CCT – ICC A117.1 Accessibility Standard
	Electrical Plans Examiner	<input type="checkbox"/> 2021 CCT – Electrical Module*
	Mechanical Plans Examiner	<input type="checkbox"/> 2021 CCT – Virginia Mechanical and Fuel Gas Code Module*
	Plumbing Plans Examiner	<input type="checkbox"/> 2021 CCT – Virginia Plumbing Code Module* <input type="checkbox"/> 2021 CCT – ICC A117.1 Accessibility Standard

***Note:**

- All trainings delivered in instructor-led format (in-person or virtual) require participants to attend the entire day of training.
- Self-paced modules are bundled consistent with the live classroom offerings except for self-paced trade modules that may be completed individually based on certification issuance.

QUICK REFERENCE GUIDE

Course Tracker			
Course	Date	Course	Date
<input type="checkbox"/> Administrative & all related codes		<input type="checkbox"/> Residential Energy	
<input type="checkbox"/> Administrative Refresher (self-paced only)		<input type="checkbox"/> Commercial Building	
<input type="checkbox"/> Elevator		<input type="checkbox"/> Commercial Energy	
<input type="checkbox"/> SFPC Edits Review		<input type="checkbox"/> Existing Building	
<input type="checkbox"/> Fire Prevention		<input type="checkbox"/> Electrical	
<input type="checkbox"/> Maintenance		<input type="checkbox"/> Plumbing	
<input type="checkbox"/> Pools and Spas		<input type="checkbox"/> Mechanical	
<input type="checkbox"/> Residential Building		<input type="checkbox"/> Fuel Gas	

Here you can record the trainings that you have completed, or those you plan to take. DHCD staff will keep track of your official records, which you can also track through your online profile on the JPVBCA Online System.

This Code Tracker gives you the opportunity to note the code sections mentioned in training that you wish to review later. Code changes are grouped by code family, and are additionally highlighted in the margin according to the color of the corresponding code book cover.

2021 USBC Administrative and Related Codes

- 102.3 Exemptions
- 107.1 Authority for Charging Fees
- 107.1.2 Refunds; 110.9 Cancellation of Permit
- 108.2 Exemptions from Application for Permit
- 108.3 Applicant Information, Processing By Mail
- 118 Buildings or Structures that Become a Threat to Public Safety During Construction

2021 Virginia Industrialized Building Safety Regulations

- 13VAC5-91-20. Application and Compliance
- 13VAC5-91-115. Change of Occupancy Classification
- 13VAC5-91-120. Unregistered Industrialized Buildings
- 13VAC5-91-160. Use of Model Codes and Standards

2021 Virginia Amusement Device Regulations

- 13VAC5-31-20 Definitions
- 13VAC5-31-30. Devices Covered and Exempt

2021 USBC Elevator Provisions

- VCC 3001.2 Emergency Elevator Communication Systems
- VCC 3005.4 Machine and Control Rooms, Control Spaces, and Machinery Spaces
- VCC 3006.1 Elevator Lobbies and Hoistway Opening Protection
- VCC 3008.1 General (Occupant Evacuation Elevators)

2021 Virginia Property Maintenance Code

- 101.1 – Change to “VPMC”
- 202 Unsafe Structure; Structure Unit for Human Occupancy
- 103.2.3 Responsibility
- 606.1 Elevators, Escalators and Dumbwaiters
- Cleanup of inspection and constructions provisions

2021 Virginia Statewide Fire Prevention Code

- Continuation of Edits
- 111.2 Service
- 405.1, 405.2 (New), Table 405.3, 405.5 – Emergency Drills
- 604.5.3 (New), 604.7 (New) - Storage in Elevator Machine Rooms and Lobbies
- 610 Clothes Dryer Exhaust Ducts
- 708, 708.1 Maintenance of Spray Fire-Resistant Materials
- 901.4.8 Maintenance of Walls and Ceilings
- 901.6.3.2 Annual Inspection Tag or Sticker
- 906.1 Portable Fire Extinguishers
- 1201.3 Mixed Systems
- 1204 (New) Portable Generators
- 1207 Electrical Energy Storage Systems
- Chapter 22 Combustible Dust-Producing Operations
- 3205.5 Aisle Maintenance in High-Piled Storage
- Cleanup of Chapter 33 – Fire Safety During Construction and Demolition
- 3303.3 (New), 3303.3.1 Daily Fire Safety Inspection
- 3313 Water Supply During Construction
- 5601.2.2.1 Permissible Fireworks (New)
- 5606.1, 5606.6 Ammunition Reloading in Commercial Operations
- 5705.5 Alcohol-Based Hand Rubs Classified as Class I or II Liquids

2021 Virginia Swimming Pool and Spa Code

- ISPSC – Code pathway from VCC
- 202 Swimout
- 305.2.10 (the 20” setback requirement) moves to 305.2.4.1 as a subsection of mesh fences
- 305.2.9 Clear zone
- 305.3 Doors and gates
- 305.4 Structure wall as a barrier
- 307.1.2.1 Munsell color value (public pools only)
- 307.1.4 Accessibility
- 307.2.5 Plaster
- 311.3 Water velocity
- 316 Heaters, Table 316.2(1) and new table 316.2(2)
- 322.3.1 Wall clearance (between ladder and pool wall)
- 324 - Equipment Rooms
- 407 – Circulation Systems (Public Pools), 407.3, 407.4
- 411.2.5 Outlined edges (of pool stair treads)
- 411.3.3 Surfaces (of beach and sloping entries)
- 504.2 – New 10-minute timer requirement
- 609 Dressing and Sanitary Facilities
- 610.7 Underwater seats benches
- 612 - Interactive Water Play Features (New)

2021 Virginia Residential Code

- R202 [RB] Grade Floor Emergency Escape and Rescue Opening (EERO)
- R202 [RB]Townhouse and [RB]Townhouse Unit
- R301.1.4 Intermodal Shipping Containers
- R301.3 Story Height
- R301.2.2.6 Irregular Buildings Item 8 (SDC C Areas)
- R301.2.2.10 Anchorage of Water Heaters (SDC C Areas)
- R302.2 Townhouse Common Wall
- R303.1 Mechanical Ventilation
- R305.1 Ceiling Height
- R310.1 Emergency Escape and Rescue Opening Required
- R310.2.4 Emergency Escape and Rescue Openings

- R310.3, R310.4 Area Wells for EERO
- R310.5, R310.6, R310.7 EERO in Existing Buildings
- R311.7, R311.8 Stairways and Ramps
- R311.7.7 Stairway and Landing Walking Surface
- R314.3 Smoke Alarm Locations
- R314.3.1 Smoke Alarms Near Cooking Appliances
- R317.1 Protection of Wood against Decay
- R320 Accessibility
- R322 Flood Hazard Areas
- R323.1.1 Storm Shelters
- R324.6 Photovoltaic Systems
- R324.6.2 Setback at Ridge
- R326 Habitable Attics
- R333.1 Sound Transmission Between Dwelling Units
- Table R403.1(1) Footing Width and Thickness
- R406.2 Foundation Waterproofing
- R506.2.3 Vapor Retarders under Concrete Slabs
- R507.3 Deck Footings
- Table R507.3.1 Minimum Footing Size for Decks
- R507.4 Deck Posts
- R507.10 Exterior Guards
- Table R602.3(1) Fasteners – Roof and Wall
- Table R602.3(1) Fasteners – Roof Sheathing
- Table R602.3(2) Alternate Attachments
- R602.9 Cripple Walls
- R602.10.1.2 Location of Braced Wall Lines
- R602.10.2.2 Location of Braced Wall Panels
- R702.7 Vapor Retarders
- Table R703.8.4(1) Tie Attachment and Airspace
- R704 Soffits
- Table R704.3.4 Prescriptive Alternative for Wood Structural Panel Soffit
- Table R802.5.2(1) Heel Joint Connections
- N1101.6 Definition of High-Efficacy Light Sources
- N1101.7 Climate Zones
- N1101.13 Compliance Options
- N1101.13.5 Additional Energy Efficiency Requirements
- N1101.14 Permanent Energy Certificate
- N1102.1 Building Thermal Envelope

- Tables N1102.1.2 and N1102.1.3 Insulation and Fenestration Requirements
- N1102.2 Ceiling Insulation
- N1102.2.7 R-Value Reduction for Walls with Partial Structural Sheathing (Deleted)
- N1102.2.7 Floor Insulation
- N1102.2.8 Unconditioned Basement
- N1102.4.6 Air-Sealed Electrical Boxes
- N1103.1.3 (VECC R403.1.3) Heat Pump as Primary Space Heat Source
- N1103.3 Duct Installation
- N1103.3.5 Duct Testing
- N1103.3.6 Ducts within Thermal Envelope
- N1103.3.7 Building Cavities (used as ducts or plenums)
- N1103.6 Mechanical Ventilation
- N1104 Lighting Equipment
- N1105 (R405) Total Building Performance and Table N1105.2
- M1404.1 Refrigeration Cooling Equipment Compliance
- M1411 – Heating and Cooling Equipment
- M1505 Balanced Ventilation System Credit
- M1802.4 (801.21) Blocked Vent Switch for Oil-fired Appliances
- M2101 Hydronic Piping Systems Installation
- G2403 (202) General Definitions
- G2414.8.3 (403.8.3) Threaded Joint Sealing
- G2415.5 (404.5) Fittings in Concealed Locations
- G2427.8 (503.8) Venting System Terminal Clearances
- G2447.2 (623.2) Commercial Cooking Appliances Prohibited
- P2503.5.1 Drain, Waste and Vent Systems Testing
- P2708.4, P2713.3 Shower and Bathtub Control Valves
- P2905.3 Length of Hot Water Piping to Fixtures
- P2906.9.1.2 (VA) Solvent cementing (CPVC piping)
- P3005.2.10.1 (708.1.6) Removable Fixture Traps as Cleanouts
- E3601.8 Emergency Service Disconnects [NEC 230.82(3), 230.85]
- E3606.5 Service Surge-Protective Device [230.67]
- E3703.4 Bathroom Branch Circuits [210.1(C)(3)]
- E4002.11 Bathtub and Shower Space [406.9(C)]
- E3703.5 Garage Branch Circuits [210.11(C)(4)]
- E3901.4 Kitchen Countertop and Work Surface Receptacles [210.52 (C)]
- E3902 GFCI Protection for 250-Volt Receptacles [210.8(A) – multiple subsections, 210.8(E)]
- E3902.5 GFCI Protection for Basement Receptacles [210.8(A)(5)]

- E3902.10 GFCI Protection for Indoor Damp and Wet Locations [210.8(A)(11)]
- E3902.17 in its Entirety (GFCI Protection for Outdoor Outlets) (Deleted)
- Appendix AF104 Radon Testing
- Appendix AW – 3D Construction

2021 Virginia Construction Code

- 202 Atrium
- 202 Penthouse
- 202 Puzzle Room
- 202 Secondary Structural Members
- 202 Definitions relating to Resiliency Updated
- 306.2 Group F-1 Occupancy
- 310.6 Residential Group R-5
- 311.2, 311.3 Alcoholic Beverage Storage
- 404.1 Scope of Atrium Provisions
- 404.5 Smoke Control in Atriums
- 404.6 Horizontal Assemblies in Atriums
- 406.2.4 Floor Surfaces in Parking Garages
- 407.3.1.1 Group I-2 Corridor Doors (New)
- 407.4 Means of Egress
- 407.4.4.1, 407.4.4.3 Group I-2 Care Suites
- 407.6.1 Automatic Closing Doors in Group I-2 (New)
- 411.5 Puzzle Rooms (New)
- 413 Combustible Storage
- [F] 414.2.3 Fire Wall Use for Control Areas
- [F] Table 414.2.5(1) Toxic Solids in Retail Occupancies
- 416.4 Spray Booths
- 422.7 Cooking in Ambulatory Care Facilities (New)
- 424 Play Structures
- 426 Combustible Dust, Grain Processing, and Storage
- 432 Plant Processing or Extraction Facilities
- 433 Electrical Energy Storage Systems (ESS)
- 503.1.4 Occupied Roof Allowances
- Table 504.4 Allowable Height in Stories
- Table 506.2 Allowable Building Area

- 506.3.2 Allowable Area Frontage Increase
- 506.3.2 Allowable Area Frontage Increase Example
- 508.4.4, Table 508.4 Separated Occupancies
- 508.5 through 508.5.11 Live/Work Units
- Table 509.1 Storage Battery Systems as Incidental Uses
- 510.2 Stairway Construction in Podium Buildings
- 603.1 Combustible Materials in Types I and II
- 704.6.1 Secondary Attachments and Fireproofing (New)
- Table 705.5 Exterior Wall Rating
- Fire Walls - 706.1 General
- 706.1.1 Party Walls
- 707.4, 716 Separations of Energy Storage Systems
- 707.5 Enclosure of Exit Passageways
- 708.1, 708.4.1 Supporting Construction for Fire Partitions
- 709.4.1 Smoke Barrier Continuity
- 710.5.2.1, 710.5.3 (New) Smoke Partition Openings
- 713.12 Top of Shaft Enclosure
- 715 Protection of Joints and Voids
- Table 716.1(2) Doors in Double Fire Walls
- 716.4 Fire-Protective Curtain Assemblies
- 717.2.3 (New), 717.6.2.1 Ceiling Radiation Dampers
- 717.4 Access to Dampers
- 717.5.2 Flex Connectors
- NEC 700.12(B) - General Requirements. (Sources of Power for Emergency Systems),
Equipment Design and Location
- [F] 806.9 Combustible Lockers as Interior Finish (New)
- 903.2.3 Group E
- [F] 903.2.4, 903.2.7, 903.2.9 Upholstered Furniture and Mattresses
- [F] 903.2.4.2 (New), 903.2.9.3 Distilled Spirits
- [F] 903.2.10 Sprinklers in Parking Garages
- [F] 903.2.10.2 (New) Mechanical-Access Parking Garages
- [F] 903.3.1.2 NFPA 13R Sprinkler Protection
- [F] 903.3.1.2.2 Corridor and Balcony Sprinklers
- 906.1 Portable Fire Extinguishers
- [F] 907.2.10 (New) Manual Alarms in Group S Buildings
- [F] 907.5.2.1.3 (New) Fire Alarm Occupant Notification
- 909.20 Smokeproof Enclosures
- [F] 911 Fire Command Centers in Groups F-1 and S-1

- 918 In-Building Emergency Communications Coverage
 - 918.1.1 Installation
 - IFC 510.4 and 510.5
 - IFC 510.4.1, 510.4.1.1, 202 Emergency Responder Communication Coverage – Signals
 - IFC 510.4, 510.4.2.4, 510.4.2.5, 510.4.2.8, 510.5.1 (New), 510.5.4 Emergency Responder Communication Coverage – Interference
 - IFC 510.5.1 Emergency Responder Communication Coverage – Antenna
- 1006.2.1 Egress from Mechanical Rooms and Penthouses
- 1006.3 Egress from Occupied Roofs
 - 1006.3.4 Single Exit Stories
- 1008.2.1 Stairway Illumination
- 1009.2.1 Accessible Elevators to Occupied Roofs
- 1009.6.2 Areas of Refuge
- 1010.1.1 Door Widths
 - 1010.1.1.1 Projections into Door Openings
- 1010.2.4 Locks and Latches
- 108.1, 110.1, 202, 1010.2.8, 1103.2.15 Emergency Supplemental Hardware
- 1011.6 Stairway Landings
- 1019.3 Exit Access Stairways
- Table 1020.1 Corridor Fire Resistance Rating
- 1020.2.1 Hoistway Opening Protection (Deleted)
- 1020.5 Dead-End Corridors
- 1026.2 Separation
- 1030.16 Handrails at Social Stairs
- 1031 Emergency Escape and Rescue Openings
- 1102 Accessible Design Compliance
- 1104.4 Accessible Multistory Buildings
- 1105.1.1 (New), Table 1105.1.1 – Automatic Doors at Public Entrances
- 1107.2 Vehicle Charging Stations
- 1108.5, 1110.2 Assisted Toileting and Bathing
- 1110.6 Bottle Filling Stations (New)
- 1110.13.2 Service Windows
- 1110.15 Operable Parts
- 1202.3 Insulation of Unvented Attics
- 1207 Enhanced Classroom Acoustics (New)
- 1208.4 Efficiency Dwelling Units
- [P] 1210.3 Restroom Privacy
- 1404.3 Vapor Retarders (New)

- Table 1404.3(4) Class II Vapor Retarders (New)
- 1406.10 Metal Composite Material Cladding
- 1503.3 Parapet Walls
- 1504.5 Ballasted Roofs
- 1504.9 Aggregate-Surfaced Roofs (New)
- 1602.1, 1603.1.4, 1605.1, 1607.14, 1609.5, 1609.6, 2308.2.3 Tornado Loads
- Table 1604.5 Assembly Spaces and I-4 Occupancies in Risk Category III
- 1605 Load Combinations
- 1606 Dead Loads
- 1607.11.4 Rope Descent Systems
- 1607.17 Fixed Ladder Live Load (New)
- 1610.2 Soil-Caused Uplift (New)
- 1611.1 Rain Loads
- 1704.6 Structural Observations
- Table 1705.3 Special Inspection of Precast Concrete
- 1705.4.1 Empirically Designed Masonry
- 1705.10 Structural Integrity of Deep Foundations (New)
- 1709.5.3 Impact Protection (New)
- 1809.5.1 Frost Protection at Required Exits (New)
- Table 1810.3.2.6 Allowable Stresses in Deep Foundations
- 1810.3.3.1.9 Helical Piles
- 1810.3.6 Deep Foundation Element Splicing
- 1901.7 Structural Concrete Tolerances (New)
- 2205.2.1 Qualified and Prequalified Connections
- 2205.2.1 Qualified and Prequalified Connections (continued)
- 2303.4.1.2 Wood Truss Bracing
- Table 2304.10.2 Sheathing Fasteners
- 2304.11 Concealed Spaces in Type IV-HT
- Table 2308.7.3.1 Rafter Tie Connections
- 2510.6 Water-Resistive Barriers for Stucco
- 3001.2 Emergency Elevator Communication Systems
- 3005.4 Machine and Control Rooms, Control Spaces, and Machinery Spaces
- 3006.1 Elevator Lobbies and Hoistway Opening Protection
- 3008.1 General (Occupant Evacuation Elevators)
- 3103.1 Special Event Structures
- 3114 Public Use Restrooms in Flood Hazard Areas (New)
- 3115 Intermodal Shipping Containers (New)
- 3302.4 Separations Between Construction Areas

2021 Virginia Energy Conservation Code – Commercial Provisions

- C202 Definitions Relating to On-Site Renewable Energy
- C202 Definitions Relating to Fan Efficiencies
- C301 Climate Zones
- Chapter 4 [CE]
- Compliance Paths - C401.2 Application
- C401.3 Envelope Certificate (New)
- C402.1.1, C402.1.1.1 Building Envelope
- Table C402.1.3 Minimum R –Values; Table C402.1.4 U-Factor Method
- Table C402.1.4, C402.1.4 Insulation and Fenestration U -Factor Criteria
- Table C402.4 U-Factor and SHGC Requirements, Table C402.4.3 SHGC Adjustment Multipliers
- C402.4 U -Factor and SHGC Requirements
- C402.5 Air Leakage
- Air Barrier Testing for Group I and R - C402.5.1.2, C402.5.2
- Air Barrier Testing for All Other Occupancies - C402.5.1.2, C402.5.3
- C402.5.11 Operable Openings Interlocking
- C403.1.2 Mechanical Systems for Data Centers
- C403.4.2.3 Automatic Start and Stop
- C403.8.3 Fan Efficiency
- C403.8.5 Low-Capacity Ventilation Fans (New)
- C405.2.8 Parking Garage Lighting Control (New)
- C405.4 Lighting for Plant Growth (New)
- C405.11 Automatic Receptacle Control (New)
- C405.12 Energy Monitoring
- C406 Additional Efficiency Requirements
- Additional Energy Efficiency Credit Options
- Appendix CB Building Thermal Envelope

2021 Virginia Existing Building Code



- 102.2.1, 103.2 Change of Occupancy; Group I-2 or I-3 Applicability
- 102.2.2 Reconstruction, Alteration, or Repair in Group R-5 Occupancies
- 103.9 Construction Documents
- 202 [A] Change of Occupancy
- 304.3.1 Operational Constraints
- 404.3 Alterations Affecting an Area Containing a Primary Function
- 502.1.1 Structural Concrete
- 603.6 Plumbing (Deleted)
- 701.1 and Chapter 14
- 1201.7 Separations Between Construction Areas; 1209.1 When Required (Water Supply in Construction Areas)
- 1201.7 Facilities Required (Deleted)

2020 National Electrical Code (NEC / NFPA 70)



- Code-Wide Changes
- 100: Definitions – Scope
- 100: Definitions – Accessible
- 100: Definitions – Accessible
- 100: Definitions – Equipotential Plane
- 100 Definitions: Dormitory Unit
- 100 Definitions: Free Air
- 100 Definitions: Fault Current and Available Fault Current
- 100 Definitions: Habitable Room
- 100 Definitions: Habitable Room
- 100 Definitions: Habitable Room
- 110.22(A) Identification of Disconnecting Means
- 110.26(C)(2) Large Equipment
- 210.8 Measurements for GFCI Protection
- 210.8(A) Dwelling Unit GFCI Protection
- 210.8(A)(5) GFCI Protection for Basements
- 210.8(A)(11) GFCI Protection for Indoor Damp or Wet Locations
- 210.8(B) GFCI Protection for other than Dwelling Units
- 210.8(B)(2) GFCI Protection for Kitchens and More
- 210.8(D) GFCI Protection for Specific Appliances

- 210.8(E) GFCI for Equipment Requiring Servicing
- VA Deletes Section 210.8(F) / E3902.17 in its Entirety (GFCI Protection for Outdoor Outlets)
- 210.11(C)(3) Bathroom Branch Circuit(s)
- 210.11(C)(4) Garage Branch Circuit(s)
- 210.12(C) AFCI for Patient Sleeping Rooms in Nursing Homes and Limited Care Facilities
- 210.52(C) Countertops and Work Surfaces
- 210.52(C)(2) Island and Peninsular Countertops and Work Surfaces
- 215.9 GFCI Protection for Feeders
- Table 220.21 General Lighting Loads by Non-Dwelling Occupancy
- 220.53 Appliance Load – Dwelling Unit(s)
- 225.30(B) Common Supply Equipment (Feeders)
- 230.46 Spliced and Tapped Conductors
- 230.67 Surge Protection for Dwelling Units
- 230.71(A) and (B) Maximum Number of Disconnects
- 230.85 Exterior Emergency Disconnect(s) for Dwelling Units
- 250.25 Grounding Systems Permitted to be Connected on the Supply Side of the Disconnect
- 250.64(B)(2) and (B)(3) Grounding Electrode Conductor Protection from Physical Damage
- 250.104(A)(1) Bonding of Metal Water Piping Systems
- 250.148 Continuity of EGCs and Attachment in Boxes
- Table 310.16 310.15(B)(16) Ampacity Tables
- 314.16(B)(5) Box Fill Calculations – EGC Conductor Fill
- 314.27(C) Boxes at Ceiling-Suspended (Paddle) Fan Outlets
- 320.80(A) Type AC Cable Ampacity-Thermal Insulation
- 337 Type P Cable
- 404.14 Rating and Use of Switches
- 406.5(G)(2) Receptacle Mounting Under Sinks
- 406.9(C) Bathtub and Shower Space
- 406.12 Tamper Resistant Receptacles
- 408.6 Short-Circuit Current Rating for Switchboards, Switchgear, and Panelboards
- 408.43 Panelboard Orientation
- 410.116(C) Recessed Luminaires Installed in Fire-Resistant Construction
- 410.118 Access to Other Boxes
- 422.5(A) GFCI Protection for Appliances
- 445.18(D) Emergency Shutdown Device at Dwelling Units
- 501.10(A)(1) Wiring Methods – Class I, Division 1 Locations

- 511.12 GFCI Protection at Commercial and Repair and Storage Garages
- 517.10(B) Applicability (Health Care Facilities)
- 517.16 Use of Isolated Ground Receptacles
- 517.26 Application of Other Articles (Health Care Facilities)
- 517.31(C)(1)(a) Identification of Essential Electrical Systems
- 518.6 Outdoor Illumination – Assembly Occupancies
- 600.5(B) Marking Requirements at Disconnects
- 620.6 GFCI Protection in Elevator Pits, Etc.
- 620.65 Signage for Selective Coordination (Elevators, Dumbwaiters, Escalators, Moving Walks, Platform Lifts, and Stairway Chairlifts)
- 625 and 625.1 Electrical Vehicle Power Transfer Systems
- 625.54 GFCI Protection for EV Charging Equipment
- 625.56 WP Enclosure for EV Charging Receptacle Outlets
- 680.2 and 680.14 Corrosive Environments
- 680.2, 680.35, and 680.45 Immersion Pools
- 680.2 and 680.50 Splash Pads
- 680.11 Underground Wiring Around Swimming Pools
- 680.21(C) GFCI Protection for Motors
- 680.22(A)(5) Pool Equipment Room Receptacle
- 680.22(E) Other Equipment in Close Proximity to a Pool
- 680.59 GFCI Protection for Nonsubmersible Fountain Pumps
- 680.84 Receptacles for Electrically Powered Pool Lifts
- 682.15 GFP for Natural and Artificially Made Bodes of Water
- 682.33(C) Bonding of Equipotential Planes
- 690.12 Rapid Shutdown of PV Systems on Buildings
- 690.13(A) Photovoltaic System Disconnecting Means
- 690.15 Disconnecting Means for Photovoltaic Equipment
- 690.41(B) System Grounding [Solar Photovoltaic (PV) Systems], Ground Fault Protection
- 690.56(C) ID of Power Sources for Buildings with Rapid Shutdown
- 695.6(J) Terminations
- 700.5(A) Emergency Systems Transfer Equipment
- 700.12(B) Emergency System Equipment Design and Location
- 702.7(A) Sign for On-Site Optional Standby Systems
- 705 Interconnected Electric Power Production Sources
- 706.2 Definitions: Energy Storage System (ESS)
- 706.9 Maximum Voltage (ESS)
- 706.30(A)(1) Nameplate-Rated Circuit Current (ESS)
- 760.121(B) Power Sources for PLFA Circuits (Fire Alarm Systems)

2021 Virginia Plumbing Code

- 202 Copper Alloy
- 202 Public and Private
- 202 Water Dispenser
- 308.9 Parallel Water Distribution Systems
- 403.3.1, 403.5 Facilities and Drinking Fountains on Accessible Routes
- 403.6 Service Sink Location
- 405.4.3 Wall Hung Fixture Carrier Standard for Water Closets
- 407.2 Bathtub waste outlets and overflows
- 410.3 Quantities of Standing versus Wheelchair Drinking Fountains
- 411.3 Emergency Showers and Eye Wash Stations Water Supply
- 412.3 & 412.4 Shower Control Valves to be Rated for the Installed Shower Head
- 412.5 Methods for Limiting Water Temperature Discharged to Bathtubs
- 412.10 and 423.3 Methods for Temperature Limitation at Head Shampoo Sinks and Footbaths
- 419.5 Tempered Water for Public Hand-Washing Facilities
- 421.3.1 Standard for Shower Waste Fittings
- 501.2 Water Heater as a Space Heater
- 602.3.5 Potable Water Pumps to Comply with NSF 61
- 605.12.3 & 605.13.6 Solder Joints to Comply with NSF 61
- 605.15.2 and 605.14.2 Solvent cementing (of CPVC joints)
- 606.1 Individual Tenant Water Shut-off Valve
- 607.1.1, 607.1.2 Water Heaters Providing Tempered Water to Fixtures
- 608.15.2.1 Discharge from Backflow Preventer Relief Opening
- 608.17.2 Backflow Device for Low Hazard Boiler Applications
- 609.2 Two Water Service Pipes for Group I-2, Condition 2 Healthcare Facilities
- 609.2.1 Tracer Wire for Buried Nonmetallic Water Service Piping Serving Hospitals
- Table 702.3 ABS Building Sewer Pipe Standard
- Push-fit DWV Fittings - 705.2.4 ABS and 705.10.4 PVC
- 708.1.6 Cleanout Equivalent
- 903.1.3 Protected Outdoor Vent Termination Method
- 915.1 Food Waste Disposers on Combination Waste and Vent Systems
- 1002.1 Direct Connection to Hydromechanical Grease Interceptor
- 1002.4.1.5 Fixture Drains Serving as a Trap Priming Method
- 1003.3.2 Food Waste Disposers
- 1202.1 Nonflammable Medical Gases

2021 Virginia Mechanical Code

- 307.1.1, 307.2.3.3 Identification
- 307.2.1.1 Condensate Discharge
- 401.4, 501.3.1 Intake Opening and Exhaust Outlet Locations
- 403.2.1.2 Recirculation of Air to Swimming Pool and Associated Deck Areas
- Table 403.3.1.1 Minimum Ventilation Rates
- Table 403.3.1.1 Note g Recirculation of Air
- 403.3.1.3 Demand Controlled Ventilation
- 403.3.2.1 Outdoor Air for Dwelling Units
- 502.20 Manicure and Pedicure Station Exhaust System
- 504.4.1 Termination Location for Dryer Exhaust
- 504.6 Booster Fans Prohibited
- 506.3.7 Factory-Built Grease Duct Slope
- 506.3.9 Grease Duct Horizontal Cleanouts
- 507.1 Smoker Ovens with Integral Exhaust
- 514.2 Energy Recovery Ventilation (ERV) Systems
- 602.2.1.8 Pipe and Duct Insulation Within Plenums
- 607.5.2 Duct Penetrations of Fire Barriers
- 608.1 Balancing
- 801.21 Blocked Vent Switch for Oil-Fired Appliances
- 905.1 New Wood-Burning Residential Hydronic Heaters
- 920 Unit Heaters
- 929 Unvented Alcohol Fuel Burning Decorative Appliances
- Chapter 11 – Major Refrigeration / Refrigerant Updates
- 1101 General – Table 1101.2
- Table 1103.1 Refrigerant Classification, Amount, and Occupational Exposure Limit (OEL)
- 1105.9 Machinery Room Means of Egress
- 1107 through 1110
- 1203 Joints and Connections

2021 Virginia Fuel Gas Code



- 202 Service Meter Assembly; Service Shutoff; and System Shutoff
- 202 Point of Delivery
- 307.2 Fuel-Burning Appliances (Concealed Condensate Piping)
- 402.7, 202 Maximum Operating Pressure (Press-Connect Joint)
- 403.8.3 Threaded Joint Sealing
- 404.5 Fittings in Concealed Locations
- 410.2 MP Regulators
- 503.8 Venting System Terminal Clearances
- 503.10.7 Vent Connector Junctions
- 618.6 Furnace Plenums and Air Ducts
- 623.2 Prohibited Location (Commercial Cooking Appliances)

2021 USBC Administrative and Related Codes



USBC Chapter 1

102.3 Exemptions



- Clarifies the USBC's scoping provisions relating to playground equipment, on recommendation from ADTAC.
- Typical playground equipment such as you would find in a back yard or school is not subject to the USBC.
 - Swing sets, jungle gyms, slides, skateboard ramps, etc.
- Non-mechanized playground equipment is not an amusement device.
- Play structures located inside any occupancy covered by the USBC are subject to the play structures section in VCC Chapter 4

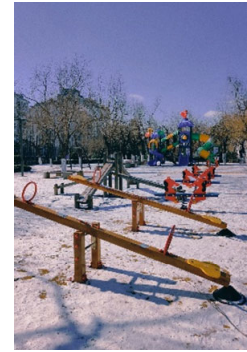

107.1 Authority for Charging Fees



- The section has been clarified to align with state law
- Permit fees collected by the building department must be used to support the building department's functions
- This change adds an exception for the levy payment in support of the VBCA, in alignment with state law



107.1.2 Refunds; 110.9 Cancellation of Permit



- Now authorizes building official to cancel permits if requested by permit holder or owner

108.2 Exemptions from Application for Permit



- This editorial change does not impact how this section is applied.
- The 5,000 gallon limit has been removed from the threshold for requiring a permit for the installation of a pool.
- Existing dimensional thresholds already limit volume to 2,244.16 gallons

$$\begin{aligned}V &= (a)(d) \\V &= (150 \text{ ft}^2)(2 \text{ ft}) \\V &= 300 \text{ ft}^3 \\300 \text{ ft}^3 &= 2244.16 \text{ gal}\end{aligned}$$

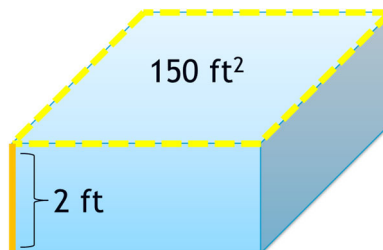

108.3 Applicant Information, Processing By Mail

Jurisdictions are now expressly allowed to process permit applications online if an online permit option for permit application and processing is offered by the locality.

118 Buildings or Structures that Become a Threat to Public Safety During Construction

This change is related to a broader set of changes intended to align the VCC and SFPC on safety during construction.

118.1 Applicability General. ~~This section applies to unsafe buildings or structures.~~ Any building or structure that is under construction and has not received a permanent certificate of occupancy, or final inspection if a CO will not be issued, that has been determined by the building official to be an immediate threat to public safety due to faulty construction, deterioration, damage, or structural instability, shall be made safe through compliance with this code or shall be demolished and removed if determined necessary by the building official.

Note: Existing buildings and structures other than those under construction or subject to this section are subject to the VMC, which also has requirements for unsafe conditions.

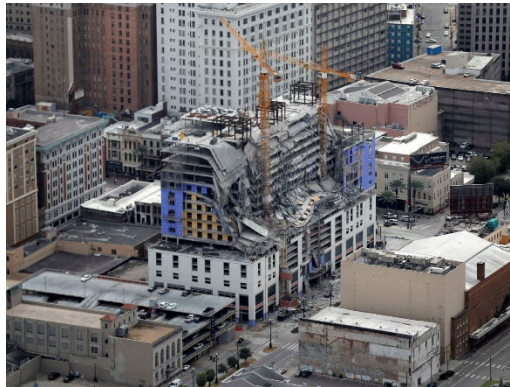

Industrialized Building Safety Regulations

13VAC5-91-20. Application and Compliance

- Clarification – provisions of subpart D are not mandatory.

D. The use of off-site manufactured intermodal freight containers, moving containers, or storage containers as building modules or components of an industrialized building ~~must~~ may be approved by the administrator in accordance with 13VAC5-91-150. In reviewing the use of the intermodal freight containers as structural building components, the administrator ~~will~~ may accept evaluation reports from accredited third-party evaluation services.



13VAC5-91-115. Change of Occupancy Classification

- Clarification
- The building official may approve a change of occupancy on a registered IB, provided they follow one of the methods listed.

13VAC5-91-120. Unregistered Industrialized Buildings

- Clarifies that the building official as some leeway when approving unregistered industrialized buildings, by following one of two paths:
 - Approve through IBSR
 - Approve under USBC

13VAC5-91-160. Use of Model Codes and Standards

- Adds standards for off-site construction
 - ICC 1200-2021: Planning, Design, Fabrication and Assembly
 - ICC 1205-2021: Inspection and Regulatory Compliance
- Provisions of this chapter supersede those of referenced codes and standards.



Virginia Amusement Device Regulations

13VAC5-31-20 Definitions

- Adds definition of “Serious Injuries/Illness”
 - "Serious Injuries/Illnesses" means a personal injury/illness that results in death, dismemberment, significant disfigurement, permanent loss of the use of a body organ, member, function, or system, a compound fracture, or other significant injury/illness that requires immediate admission and overnight hospitalization and observation by a licensed physician.
- Incorporated from ASTM F747 Standard Terminology Relating to Amusement Rides and Devices.



13VAC5-31-30. Devices Covered and Exempt

This change to the VADR aligns with USBC section 102.3 Exemptions for playground structures. This revision is a clarification, not a change to the way the regulations are applied. Typical playground equipment, such as swings, slides, jungle gyms, etc., are not within the scope of the VADR.

2021 Code Change Training: Elevator Provisions

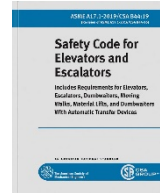

A17.1 – 2019 Referenced

- Updated reference for equipment permitted under the 2021 USBC



3001.2 Emergency Elevator Communication Systems

- Clarifies provisions for 2-way communication features for accessible elevators
- System to provide both visible text and audible modes, and
 - When operating in each mode, allows for back-and-forth conversation between elevator occupants and emergency personnel
 - Is operational when elevator is operational
 - Allows occupants to select either text-based or audible mode depending on needs.

3005.4 Machine and Control Rooms, Control Spaces, and Machinery Spaces

- This change correlates the VCC with IBC requirements for fire service access elevators.
- The provisions now exclude fire service access elevators (FSAEs) and occupant evacuation elevators (OEEs) from the exceptions for fire protection in the space or room. Each type of elevator is intended to remain running throughout a fire event.

3006.1 Elevator Lobbies and Hoistway Opening Protection

- This revision corrects several broken links that were present due to an existing Virginia amendment deleting the section in its entirety.



3008.1 General (Occupant Evacuation Elevators)

- Eliminates the conflict in the 2018 VCC.
- This change fixes a conflict that we have been aware of for some time. We said we'd fix it – and here it is. This change correlates the VCC with IBC section 3008.1.1 for the purpose of determining the number of available occupant evacuation elevators that are required, based on egress analysis.
- Virginia's 420 ft threshold for these types of elevators remains.

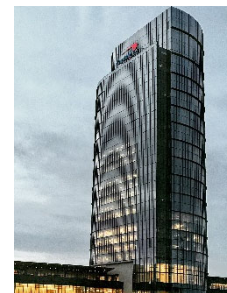

2021 Code Change Training: Virginia Maintenance Code

101.1 – Change to “VPMC”



- Historically, Virginia has shortened the name to “Virginia Maintenance Code” or “VMC”
- This has been changed to "Virginia Property Maintenance Code" and "VPMC" to eliminate confusion with the VA Mechanical Code (VMC).

101.1 Short title.

The Virginia Uniform Statewide Building Code, Part III, the Virginia Maintenance Code, may be cited as the “Virginia Property Maintenance Code”, or as ~~the “VMC”~~ the short title of “VPMC”

Significant Definition Change: *Unsafe Structure* revised; *Structure Unit for Human Occupancy* deleted



Overall intent of this code change (Proposal PM103.2-21): simplify the unsafe building provisions of the VPMC and eliminate the two versions of “unsafe” (unsafe structure and structure unfit for human occupancy) and **combine them into one definition and process.**

UNSAFE STRUCTURE. An existing structure determined by the code official to be dangerous to the health, safety and welfare of the occupants of the structure or the public because of, but not limited to, any of the following conditions:

1. The structure contains unsafe equipment;
2. The structure is so damaged, decayed, dilapidated, structurally unsafe or of such faulty construction or unstable foundation that partial or complete collapse is likely;
3. The structure is unsecured or open;
4. The degree to which the structure is in disrepair or lacks maintenance, ventilation, illumination, sanitary or heating facilities or other essential equipment;
5. The required plumbing and sanitary facilities are inoperable.

- There are numerous VPMC Code sections impacted – summary of changes shown below:
 - **103.2 Maintenance requirements** – Removes reference to *structure unfit for human occupancy*.
 - **105.2 Notices reports and orders** – *unsafe structure* notice is added to the list of notices detailed in this section
 - **105.4 Notice of violation** – deletes exception #1, now addressed in 106
 - **105.6 Further action when violation not corrected** – adds notice of *unsafe structure*
 - **105.6.1 Further action for corrected violations** – adds notice of *unsafe structure*

- **SECTION 106 - UNSAFE STRUCTURES OR STRUCTURES UNFIT FOR HUMAN OCCUPANCY –**
Section title updated
 - **106.1 General** – Removes reference to *structure unfit for human occupancy* and. “razed or removed” was replaced with the term “demolished” for consistency as the term is used in other sections within Section 106.
 - ~~**106.2 inspection of unsafe or unfit structures**~~ – section deleted
 - ~~**106.3 notice of unsafe structure or structure unfit for human occupancy**~~ – Removes reference to *structure unfit for human occupancy*.
 - **106.4 vacating unsafe structure** – Code language clarified
 - **106.5 posting of placard** – Removes references to *structure unfit for human occupancy* and added the reference to *unsafe structures*.
 - **106.6 revocation of certificate of occupancy** – Removes references to *structure unfit for human occupancy*
 - **106.7 vacant and open structures** – Removes references to *structure unfit for human occupancy*
 - **106.8 emergency repairs and demolition** – Removes references to *structure unfit for human occupancy*
 - **106.9 closing of streets** – Removes references to *structure unfit for human occupancy*

103.2.3 Responsibility



103.2.3 Responsibility.

The owner of a structure shall provide and maintain all buildings, structures, systems, facilities and associated equipment in compliance with this code unless it is specifically expressed or implied that it is the responsibility of the tenant or occupant.

Note: Where an owner states that a tenant is responsible for performing any of the owner's duties under this code, the code official may request information needed to verify the owner's statement, as allowed by § 55-11209 A 5 of the Code of Virginia. A tenant's responsibility is limited and protected under the Virginia Residential Landlord and Tenant Act.

- Added to note to make code official aware that the landlord and tenant act may limit these responsibilities.

606.1 Elevators, Escalators and Dumbwaiters



- Makes the requirements of ASME A17.1 (Safety Code for Elevators and Escalators, 2019 ed.) Appendix N (Recommended inspection and test intervals) mandatory and enforceable

Additional details from the proponent: “This proposal (PM606.1-21) is an effort to correct the unintended consequence of deleting reference to Appendix N from the International Property Maintenance Code. These periodic tests are essential to maintaining operational safety of the equipment. The section is re-ordered so that inspection types follow the inspection requirement and display of the certificate of inspection follows inspection types. Since dumbwaiters have historically been omitted from the annual inspection requirement they are also deleted from testing and display of certificate of inspection while maintenance in compliance with ASME A17.1 remains.”

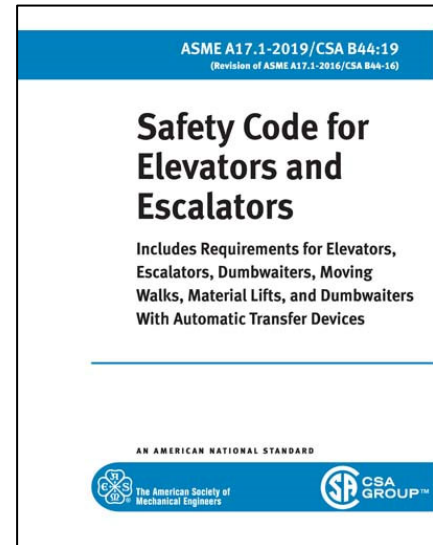

Cleanup of inspection and constructions provisions

This section includes several changes designed to remove invalid construction provisions for installation and repairs, and construction related inspection provisions. (Items already addressed in the VCC, VRC, VEBC or other adopted codes)

505.3 Inspection and testing of Backflow prevention systems

505.3.1 ~~Inspections~~ Maintenance

505.3.2 Testing

- Language updated to “maintenance and testing” because these provisions are outside the scope of a maintenance code. Inspection and testing for new installations or repairs are already addressed in the VCC, VEBC, VRC or VPC. (Proposal PM505.3-21)

703 Fire-resistance Ratings

704 Fire Protection Systems

705 Carbon Monoxide Alarms and Detection

- Invalid construction and retrofit provisions were removed from these sections because new installations or repairs are already addressed in the VCC, VEBC, VRC or VPC. (Proposals PM703.2-21, PM704.1.1-21, and PM705.1-21)

704.3 Systems out of service

704.4 Removal or tampering with equipment

704.5 Fire department connection access

- Removes code provisions that are the responsibility of the Fire Official and already enforced under the SFPC. (PM704.3-21, PM704.4-21, and PM704.5-21)

2021 Code Change Training: Virginia Statewide Fire Prevention Code

Continuation of Edits



- Continued edits to remove new unenforceable construction provisions from 2021 IFC
- The Statewide Fire Prevention Sub-Workgroup reviewed and agreed to all of the edits to the 2021 edition.

111.2 Service



- A notice of violation is now allowed to be served by email.
- This is not intended to replace in-person or physical mail delivery of the notification, it's just an additional option for delivery.

405.1, 405.2 (New), Table 405.3, 405.5 – Emergency Drills

- Formerly Table 405.2
- Lockdown plans are not required; but must be approved if they exist.
- Such drills cannot substitute for fire and evacuation drills.
- Clarifies requirements for fire and evacuation drills
- The following existing Virginia amendments impact this group of changes:

- Exception to 405.1

Exception: Emergency evacuation drills shall not be conducted in school buildings during periods of mandatory testing required by the Virginia Board of Education.

- Table 405.3 (formerly Table 405.2)

1. Frequency and participation in Group R SRCFs except hospice; and
2. Footnote b: emergency evacuation drills in Group R-2 college and university buildings, senior citizens 55 years of age or older, other Group R-2

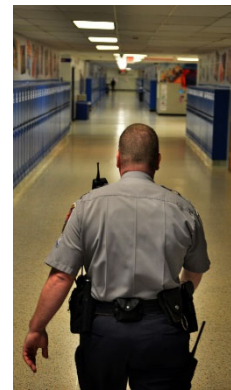

604.5.3 (New), 604.7 (New) - Storage in Elevator Machine Rooms and Lobbies

- Storage is prohibited in elevator lobbies (where hoistway opening protection is required), elevator cars, and elevator machine rooms.
- It is important to note that although Section 3006.2 of the IBC is incorporated into the 2021 VCC, it only applies if elevator hoistway openings and enclosed elevator lobbies are provided voluntarily in order to comply with other applicable requirements of the code (see Section 3006.1 of the 2021 VCC).
- The proposal also included a change to Section 315.3.3, which now prohibits the storage of combustibles in elevator machine rooms.

610 Clothes Dryer Exhaust Ducts

- New section dealing with dryer fires
- Clothes dryer components must be maintained to prevent the accumulation of lint and debris.
 - Lint trap
 - Heating components
 - Exhaust duct
 - Termination cover
- Installation requirements already existed; this just adds the pointer.



708, 708.1 Maintenance of Spray Fire-Resistant Materials

- Intumescent fire-resistant materials and spray applied fire-resistant materials must be visually inspected and maintained.
- 701.6 requires annual inspection by owner
- While the 2021 IFC adds a new section for the maintenance of spray fire-resistant materials and intumescent fire-resistant materials, similar provisions have already been stipulated in Section 701.6 of the SFPC. That section specifies the frequency of the required visual inspection, and clarifies that it must be performed by the owner as opposed to the AHJ.



901.4.8 Maintenance of Walls and Ceilings



- Wall and ceiling panels are required to be in place, where they are required for fire protection systems to operate as designed.



901.6.3.2 Annual Inspection Tag or Sticker



Annual inspection tags are now required to include 4 specific pieces of information:

1. Name of agency and individual who performed work;
2. Date of inspection or test;
3. Type of inspection or test; and
4. Result of the inspection or test

906.1 Portable Fire Extinguishers

- Extinguishers are not required in unoccupied Group U communication equipment structures

1201.3 Mixed Systems

- Sets max quantity of energy stored regardless of technology used
- Authorizes FO to seek expert opinion as necessary to report on unusual, detailed or complex technical issues

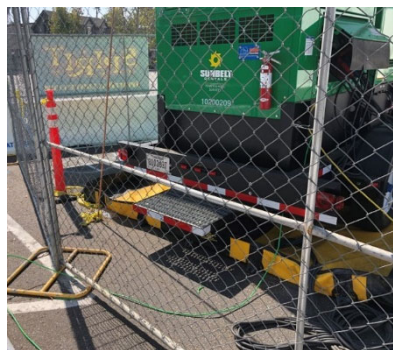

1204 (New) Portable Generators

- Portable generators manufactured after 1/1/21 must be listed to UL 2201
- Must be grounded
- Portable generators operated:
 - Only outdoors or enclosed areas
 - $\geq 5'$ from building openings or air intakes
 - Separation from tents per Ch 31
- Temporary wiring shall be provided with GFCI

1207 Electrical Energy Storage Systems

The requirements for energy storage systems have been reformatted and revised to better address this growing and changing technology. Construction requirements have been removed from the SFPC and are found in the VCC. The SFPC workgroup reviewed all of 1207 and either deleted construction language, or revised the verbiage to maintenance requirements. Some requirements were already operational/maintenance in nature and remain unmodified by VA.

- Formerly 1206
- Covers both stationary and mobile energy storage systems
- Operational permit required

Chapter 22 Combustible Dust-Producing Operations

The chapter is revised to include criteria for mitigating the accumulation of combustible dust and control of ignition sources

- Housekeeping
- Emergency response plan
- Employee training



3205.5 Aisle Maintenance in High-Piled Storage

- Formerly 3205.4
- Displays are allowed to encroach into the required aisle width IF:
 - Sprinklers have K-factor of 25.2 and comply with NFPA 13 21.9.1
 - Height $\leq 48''$
 - Clear aisle $\geq 48''$

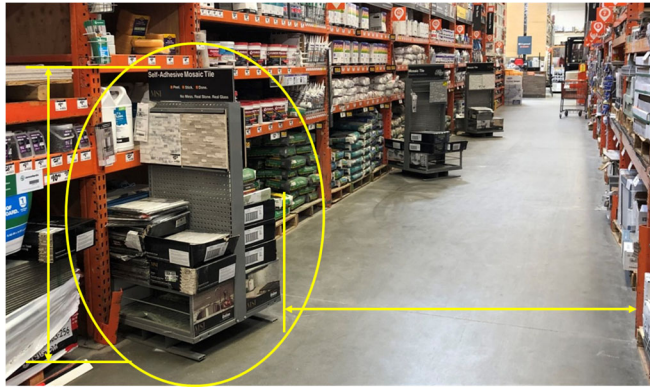

3303.3 (New), 3303.3.1 Daily Fire Safety Inspection

- Owner shall designate a Site Safety Director for construction and remodel
- Daily inspection of building and site where construction is occurring
 1. Contractors entering to perform hot work have been instructed in the hot work safety requirements
 2. Temporary heating equipment is properly used
 3. Combustible debris, rubbish and waste material is removed
 4. Temporary wiring does not have exposed conductors
 5. Flammable liquids and other hazardous materials are stored in locations approved by the site safety director
 6. Access roads are maintained clear of obstructions
 7. Fire hydrants are clearly visible and not obstructed
 8. FDCs are clearly identified and not obstructed
 9. Standpipe systems are in service and continuous to the highest work floor
 10. Portable fire extinguishers are available in required locations
- The change to 3303.3.1 was submitted by the VA Fire Services Board Codes and Standards  Committee to better coordinate the provisions across the codes. This is part of a group of changes that align the SFPC, VCC, and VEBC on fire safety during construction.

3313 Water Supply During Construction

- Formerly 3312
- Water supply required when combustible building materials arrive on site
 - Minimum 500 GPM
 - Fire hydrant $\leq 500'$ of the combustible materials
- Water supply required when standpipe is available
 - Minimum 500 GPM
 - Fire hydrant $\leq 100'$ of FDC
- Minimum fire flow of 500 GPM is increased for Type III, IV or V buildings before vertical construction commences
 - Full fire flow if building $\leq 30'$ of property line that can be built on
 - 50% of full fire flow if building $>30'$ and $\leq 60'$ of property line that can be built on
 - Minimum of 500 GPM is acceptable during construction if building $>60'$ of property line that can be built on



Cleanup of Chapter 33 – Fire Safety During Construction and Demolition



- “Cleanup” to align with 2021 VCC amendments to remove construction language

5601.2.2.1 Permissible Fireworks (New)



- NFPA 1124-2006 now referenced for fireworks sale and storage
- Newer standard does not address “permissible” fireworks

5606.1, 5606.6 Ammunition Reloading in Commercial Operations

- Requirements for ammunition reloading in commercial operations are added to the code. These requirements do not apply to personal reloading operations.
- Control of ignition sources
 - Classified electrical $\leq 3'$ of equipment
 - Static control and grounding
 - Approved containers for storage
 - Smokeless powder in original containers only
 - Approved containers with lid for waste disposal
 - Empty at least each day or end of shift



5705.5 Alcohol-Based Hand Rubs Classified as Class I or II Liquids



- Clarified language to include all approved dispensers, not just “wall-mounted”



This page intentionally left blank

2021 Code Change Training: International Swimming Pool and Spa Code

ISPSC layout and number of changes

Chapters	Subjects	Changes
1	Scope and Administration	0
2	Definitions	5
3	General Compliance	11
4	Public Swimming Pools	3
5	Public Spas and Public Exercise Spas	1
6	Aquatic Recreation Facilities	4
7	Onground Storable Residential Swimming Pools	0
8	Permanent Inground Residential Swimming Pools	0
9	Permanent Residential Spas and Permanent Residential Exercise Spas	0
10	Portable Residential Spas and Portable Residential Exercise Spas	0
11	Referenced Standards	

ISPSC – Code pathway from VCC

VCC Section 3109 - Swimming pools, swimming pool enclosures, and aquatic recreational facilities

3109.1 General. Swimming pools, swimming pool enclosures and aquatic recreational facilities, as that term is defined in the International Swimming Pool and Spa Code, shall comply with applicable provisions of the International Swimming Pool and Spa Code.

VRC - R327.1 (previously R326.1) General. The design and construction of pools and spas shall comply with the International Swimming Pool and Spa Code.

202 Definition of *Swimout*

SWIMOUT. An underwater seat area that is placed completely outside of the ~~perimeter shape~~ diving envelope of the pool. Where located at the deep end, swimouts are permitted to be used as the deep-end means of entry or exit to the pool.

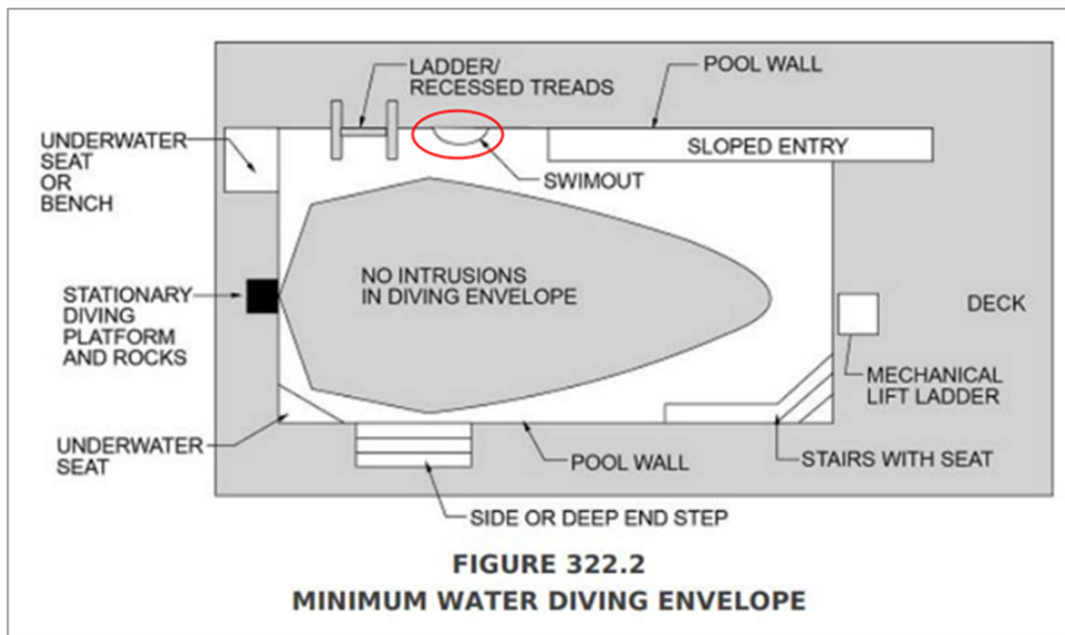

Note: There are additional new and/or modified definitions covered later in this module along with their related code sections.

Chapter 3 – General Compliance

305.2.10 (the 20" setback requirement) moves to 305.2.4.1 as a subsection of mesh fences

- In prior editions of the code, this section was located such that it was applicable to all types of barriers, not just removable mesh fences. This section's new location narrows the requirement to only mesh fences and not other types of fences such as chain link fence.
- This proposal clarifies the original intent of section 305.2.10, which was to apply only to mesh fences
- This change could have a significant impact on the size and/or design of the pool or spa

305.2.4.1 Setback for mesh fences.

The inside of a mesh fence shall be not closer than 20 inches (508 mm) to the nearest edge of the water of a pool or spa.

305.2.9 Clear Zone

- This section had caused much confusion and questions in the past, so Virginia had previously amended this section to clarify that it only applies to equipment located on the same lot as the pool or spa.
- The new ISPSC section now aligns with the expanded Virginia code language, and a VA amendment is no longer necessary

305.2.9 Clear zone.

Where equipment, including pool equipment such as pumps, filters and heaters, is on the same lot as a pool or spa and such equipment is located outside of the barrier protecting the pool or spa, such equipment shall be located not less than 36 inches (914 mm) from the outside of the barrier.

305.3 Doors and Gates

- Doors have been added to the scope of this section, so the section is now titled “doors and gates”
- **305.3.3 Latch Release** - is expanded to include self-locking and non self-locking gate and door types, with specific requirements for height at public and private facilities

Latch type	Height above finished floor or ground surface
Non self-locking mechanism accessed from outside barrier	Public – 52-54” min/max Residential – Not less than 54”
Self-locking type (key, electronic, combination)	Public – 34-48” min/max Residential – Not greater than 54”
Private – where only device is self-latching and located on the pool and spa side of the barrier	At least 3” below the top of the gate

- **305.3.4 Barriers Adjacent to Latch Release Mechanisms** – now its own subsection but requirements aren’t new (requirements were previously located in 305.3.3)

305.3.4 Barriers adjacent to latch release mechanisms.
Where a latch release mechanism is located on the inside of a barrier, openings in the door, gate and barrier within 18 inches (457 mm) of the latch shall not be greater than 1/2 inch (12.7 mm) in any dimension.

305.4 Structure Wall as a Barrier

- Adds "gates" and lists out the height requirement for alarm deactivation switches for different occupancy types. Here is a summary of the updated section's alarm deactivation switch requirements:

Dwelling type	Operable parts of alarm deactivation switches – height above finished floor
Dwelling NOT required to be accessible, Type A or Type B (Such as an R-5)	At least 54" (not new)
Dwelling required to be accessible, Type A or Type B (R-1 or R-2)	48-54" min/max (not new)
Structures other than dwellings (new for 2021)	

- Updated section 305.4 code text shown on next page

- DHCD is confident there was a formatting error in this approved proposal. Although the new section appears to add options – the intent was not to change the 3 overall protection options (alarm, listed cover or other *approved* means). It appears that new items 2, 3 and 4 should have been added as subsections of option #1 (as 1.1, 1.2 and 1.3 respectively), as they all deal with height requirements related to the audible alarm option – and aren't standalone options.

305.4 Structure wall as a barrier.

Where a wall of a dwelling or structure serves as part of the barrier and where doors, gates or windows provide direct access to the pool or spa through that wall, one of the following shall be required:

1. Operable windows having a sill height of less than 48 inches (1219 mm) above the indoor finished floor, doors and gates shall have an alarm that produces an audible warning when the window, door or their screens are opened. The alarm shall be listed and labeled as a water hazard entrance alarm in accordance with UL 2017.
2. In dwellings not required to be Accessible units, Type A units or Type B units, the operable parts of the alarm deactivation switches shall be located at not less than 54 inches (1372 mm) above the finished floor.
3. In dwellings that are required to be Accessible units, Type A units or Type B units, the operable parts of the alarm deactivation switches shall be located not greater than 54 inches (1372 mm) and not less than 48 inches (1219 mm) above the finished floor.
4. In structures other than dwellings, the operable parts of the alarm deactivation switches shall be located not greater than 54 inches (1372 mm) and not less than 48 inches (1220 mm) above the finished floor.
5. A safety cover that is listed and labeled in accordance with ASTM F1346 is installed for the pools and spas.
6. An approved means of protection, such as self-closing doors with self-latching devices, is provided. Such means of protection shall provide a degree of protection that is not less than the protection afforded by Item 1 or 2.

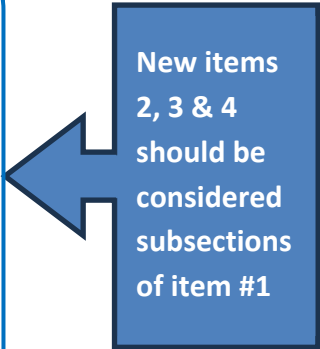

New items
2, 3 & 4
should be
considered
subsections
of item #1

307.1.2.1 Munsell Color Value (Public Pools Only)

- This new section requires pool finishes to be "not less than 6.5 on the Munsell color value scale"
- This is a method to quantify the brightness level of **any color** and is based on Model Aquatic Health Code (MAHC) requirements
- There are 8 exceptions:
 1. Competitive lane markings.
 2. Floors of dedicated competitive diving wells.
 3. Step or bench edge markings.
 4. Pools shallower than 24 inches (609.6 mm).
 5. Water line tiles.
 6. Wave and surf pool depth change indicator tiles.
 7. Depth change indicator tiles where a rope and float line is provided.
 8. Features such as rock formations, as *approved*.
- The requirements for visible outlets and the 8" black disc test remain in section 321-Lighting

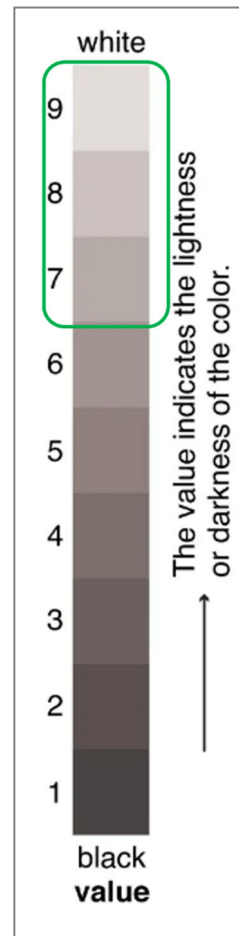

307.1.4 Accessibility

- This section is modified to add a sentence requiring that pool and spa lifts be listed and labeled to UL 60335-2-1000 and be installed per ICC A117.1 (accessibility standard) and NFPA 70 (NEC)
- This new standard (UL 60335-2-1000) provides electrical and mechanical loading requirements and complies with the prescriptive requirements in ANSI/ICC A117.1

307.1.4 Accessibility.

An accessible route to public pools and spas shall be provided in accordance with the International Building Code. Accessibility within public pools and spas shall be provided as required by the accessible recreational facilities provisions of the International Building Code. Pool and spa lifts providing an accessible means of entry into the water shall be listed and labeled in accordance with UL 60335-2-1000 and be installed in accordance with ICC A117.1 and NFPA 70.

307.2.5 Plaster

- A new section and standard are added to cover plaster installation
- The Association of Pool & Spa Professionals, in conjunction with the National Plasters Council and ICC have developed the ANSI/APSP/NPC/ICC-12 American National Standard for the Plastering of Swimming Pools. This Standard provides clear requirements when plastering a swimming pool or a permanently installed concrete spa, in both residential and commercial settings.

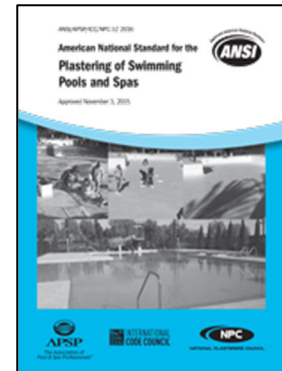

307.2.5 Plaster.

The plastering of pools and permanently installed concrete spas shall be in accordance with APSP/NPC/ICC-12.

311.3 Water velocity

- While this is primarily a design/plan review consideration, this modification adds a 6fps (feet per second) limit for public pool suction piping - consistent with requirements found in APSP and Model Aquatic Health Code (MAHC) standards

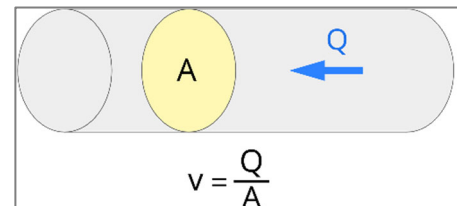

311.3 Water velocity. The water velocity in suction and return piping shall comply with either Section 311.3.1 or 311.3.2. The water velocity in copper and copper alloy piping shall not exceed 8 fps (2.4 mps). All water velocity calculations shall be based on the design flow rate specified for each recirculation system.

311.3.1 Public pools and spas. For public pools and spas, suction piping water velocity shall not exceed 6 fps (1.8 mps) and return piping water velocity shall not exceed 8 fps (2.4 mps).

311.3.2 Residential pools and spas. For residential pools and spas, the water velocity in suction piping and return piping shall not exceed 8 fps (2.4 mps).

316 Heaters, Table 316.2(1) and new table 316.2(2)

- Adds hot water storage tanks to the listing and labeling requirements
- Certain standards are updated or added, including UL/CSA 60335-2-40 “Standard for Safety for Household and Similar Electrical Appliances, Part 2-40 Particular Requirements for Electrical Heat Pumps, Air-Conditioners and Dehumidifiers.”
- There is now a separate table for “water heating systems and components”, which currently only contains the standards for a “solar water heater”, which is the relatively new ICC/APSP 902/SRCC 400 Solar Pool and Spa Heating System Standard – 2018 edition
- In section 316.6 – Terminology was updated to “water heating systems” (was “solar thermal water heaters”). “Thermal water heaters” or “solar thermal” was no longer accurate as the standard allows for the use of photovoltaic modules as part of these systems, and “water heating systems” is a more universal term

TABLE 316.2(1) WATER HEATERS	
DEVICE	STANDARD
Electric water heater	UL 1261, UL 1563 or CSA C22.2 No. 218.1
Gas-fired water heater	ANSI Z21.56/CSA 4.7a
Heat exchanger	AHRI 400
Heat pump water heater	AHRI 1160 and one of the following: CSA C22.2 No. 236, UL 1995, or UL/CSA 60335-2-40

TABLE 316.2(2) WATER HEATING SYSTEMS AND COMPONENTS	
SYSTEM	STANDARD
Solar water heater	ICC/APSP 902/SRCC 400

This table is new

UL/CSA 60335-2-40 is added

322.3.1 Wall Clearance (between ladder and pool wall)

- The clearance range for the space between the ladder and the pool wall has been REDUCED to 3" min/4" max (was 3" min, 6" max)
- The 4" maximum aligns with other requirements for fences, railings, and gaps in playground equipment, to help prevent children from getting their head stuck in the opening
- The 3" minimum gap (unchanged) is to prevent smaller spaces that could pose a limb entrapment hazard

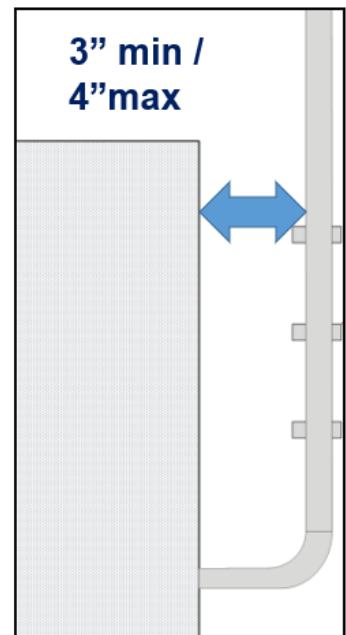

New Section 324 - Equipment Rooms

Equipment Room Related Terms and Definitions	
<i>Chemical Storage Space</i>	A space in an aquatic facility used for the storage of pool or spa chemicals such as acids, salt, or corrosive or oxidizing chemicals.
<i>Equipment Room</i>	A space intended for the operation of pool pumps, filters, heaters, and controllers. This space is not intended for the storage of hazardous pool or spa chemicals.
<i>Indoor aquatic facility</i>	A physical place that contains one or more pools or spas and the surrounding bather and spectator/stadium seating areas within a structure that meets the definition of “Building” in the International Building Code. It does not include equipment, chemical storage, or bather hygiene rooms or any other rooms with a direct opening to the aquatic facility. Also known as a natatorium.

Section Summary – 324 Equipment Rooms

- 324.1 General.
- 324.2 Requirements.
- 324.3 Construction.
- 324.4 Electrical.
- 324.5 Ventilation.
- 324.6 Markings.
- 324.7 Separation from chemical storage spaces.
 - 324.7.1 Doors and openings.
 - 324.7.2 Indoor aquatic facility access.
 - 324.7.2.1 Automatic closer and lock.
- 324.8 Chemical storage space.
 - 324.8.1 Chemical storage space doors.
 - 324.8.1.1 Interior opening doors.
 - 324.8.2 Interior chemical storage spaces.
 - 324.8.2.1 Air ducts in interior chemical storage spaces.
 - 324.8.2.2 Pipes and tubes in interior chemical storage spaces.
 - 324.8.2.3 Combustion equipment in interior chemical storage.
- 324.9 Ozone rooms.
 - 324.9.1 Signage.
 - 324.9.2 Alarm system.
- 324.10 Gaseous chlorination space.
- 324.11 Windows.
- 324.12 Sealing and blocking materials.

Chapter 4 – Public Swimming Pools

407 – Circulation Systems (Public Pools), 407.3, 407.4

- Previously this section only included the turnover rate provisions and referred the reader to Section 311 (General – Circulation Systems) for all other requirements
- This change adds several new requirements in new sections 407.3 and 407.4 for public swimming pool systems to ensure adequate in-pool distribution of sanitizers and filtered water
- Requirements are consistent with the Model Aquatic Health Code (MAHC) – full ISPCS code text from added sections included below

407.3 Continuous water removal. The design of a gutter system shall accommodate continuous removal of water from the pool's upper surface at a rate of not less than 125 percent of the required total recirculation flow rate as determined by the design professional.

407.3.1 Gutter outlets. At a gutter flow condition of not less than 125 percent of the total recirculation flow as determined by the design professional, gutter outlets such as drop boxes, converters, return piping, or flumes shall be designed to prevent flooding of the gutter that would result in skimmed water re-entering the pool.

407.3.2 Adequate mixing. Pools shall have wall or floor inlets or both to provide for adequate mixing. Inlets shall be hydraulically sized to provide the design flow rates for each area of the pool proportional to the turnover rate and the area covered by the inlet.

407.4 Pool circulation. The filtration circulation system shall be designed with sufficient flexibility to achieve a hydraulic apportionment that will ensure effective distribution of treated water throughout the pool.

407.4.1 Inlets. Effective distribution of treated water shall be accomplished by either a continuous perimeter overflow system with integral inlets or by means of directionally adjustable inlets adequate in design, number, and location.

407.4.2 Adequate mixing. Pools shall have wall or floor inlets or both to provide for adequate mixing. Inlets shall be hydraulically sized to provide the design flow rates for each area of the pool proportional to the turnover rate and the area covered by the inlet.

407.4.3 Floor inlets. Floor inlets shall be required for pools that are greater than 50 feet (15.2 m) wide. The spacing between floor inlets shall not exceed 20 feet (6.1 m). Pools having only floor inlets shall have such inlets located within 15 feet (4.6 m) of the perimeter waterline. Where wall inlets are used in combination with floor inlets, the floor inlets shall be located not greater than 25 feet (7.6 m) from the nearest side walls.

407.4.4 Wall inlets. The spacing between wall inlets shall not exceed 20 feet (6.1 m), measured along the perimeter waterline.

411.2.5 Outlined Edges (of pool stair treads)

- Adds a new requirement for public pool stair treads
- Intent is to provide additional safety for users when entering or exiting a public pool
- Requirement is consistent with the Model Aquatic Health Code (MAHC)

411.2.5 Outlined edges.

The leading horizontal and vertical edges of stair treads shall be outlined with slipresistant contrasting tile or other permanent marking of not less than 1 inch (25.4 mm) and not greater than 2 inches (50.8 mm).

411.3.3 Surfaces (of beach and sloping entries)

- Clarifies requirements for slip resistant walking surfaces at beach and sloping entries

411.3.3 Surfaces.

Beach and sloping entry walking surfaces at water depths up to 36 inches (914 mm) shall be slip resistant.

Vs. 2018 section:

Beach and sloping entry surfaces shall be of slip-resistant materials.

Chapter 5 – Public Spas and Public Exercise Spas

504.2 – New 10-minute timer requirement

- New section requires a 10-minute maximum timer and specifies where timer controls must be located
- Consistent with requirements found in many state and local health codes

SECTION 504 PUMPS AND MOTORS

504.2 Timer.

The operation of the hydrotherapy jets shall be limited by a cycle timer having a maximum setting of 10 minutes. The cycle timer shall be located not less than 5 feet (1524 mm) away, adjacent to, and within sight of the spa.

Chapter 6 – Aquatic Recreation Facilities

SECTION 609 ~~TOILET ROOMS~~ DRESSING AND BATHROOMS SANITARY FACILITIES

- Updates to this section address the previous inconsistency between the ISPC and the construction and plumbing codes by limiting these requirements to “dressing facilities and number of cleansing and rinse showers”

609.1 General.

Dressing and sanitary facilities shall be provided in accordance with the minimum requirements of the International Building Code and International Plumbing Code and Sections 609.2 through 609.9.

609.2 Number of fixtures.

The minimum number of required water closets, urinals, lavatory, and drinking fountain fixtures shall be provided as required by the International Building Code and International Plumbing Code and the dressing facilities and number of cleansing and rinse showers shall be provided in accordance with Sections 609.2.1, 609.2.2, and 609.3.1.

609.2.1 Water area less than 7500 square feet.

Facilities that have less than 7500 gross square feet (697 m²) of water area available for bather access shall have dressing facilities and not less than one cleansing shower for males and one cleansing shower for females.

609.2.2 Water area 7500 square feet or more.

Facilities that have 7500 gross square feet (697 m²) or more of water area available for bather access shall have dressing facilities and not less than one cleansing shower for males, and one cleansing shower for females for every 7500 square feet (697 m²) or portion thereof. Where the result of the fixture calculation is a portion of a whole number, the result shall be rounded up to the nearest whole number.

610.7 Underwater seats benches

- Definition update - Was “Underwater Seat”
- Code referred to both underwater seats and benches but only “underwater seat” was defined

202 Definitions - Underwater seat bench

An underwater ledge ~~that is~~ seat that can be recessed into the pool wall or placed completely inside the perimeter shape of the pool, generally located in the shallow end of the pool.

610.7 Underwater Benches

610.7.1 Location.

Underwater benches shall only be located in areas where the pool water depth does not exceed 5 feet (1.5 m).

610.7.2 Surface dimensions.

Underwater benches shall have an unobstructed surface dimension of not less than 16 inches (406 mm) and not greater than 22 inches (559 mm) in depth measured front to back and not less than 26 inches (660 mm) in width.

SECTION 612 - INTERACTIVE WATER PLAY FEATURES (NEW)

- **New definition**

INTERACTIVE WATER PLAY FEATURES.

Any indoor or outdoor structure designed to allow for public recreational activities with recirculated, filtered, and treated water that includes sprayed, jetted or other water sources contacting bathers and not incorporating standing or captured water as part of the bather activity area. These installations are also known as splash pads, spray pads, and wet decks.

- This new section regulates many important safety aspects of these water features including requirements for decking, splash pad zone, and water sanitation among others
- Based on industry best practices and provisions of the Model Aquatic Health Code (MAHC)

SECTION 612 - INTERACTIVE WATER PLAY FEATURES

612.1 General.

612.2 Safety hazards.

612.3 Decking.

612.4 Splash pad zone.

612.4.1 Surface.

612.4.2 Slope and water collection.

612.4.3 Nozzles

612.4.4 Other nozzles.

612.5 Water sanitation.

612.5.1 Water collection and treatment tank.

612.5.2 Filtration pump.

612.5.3 Spray nozzle and water feature water disinfection.

612.5.4 Disinfection system.

612.5.5 Make-up water system.

612.6 Operating instructions.

612.7 Lighting.

There are no significant changes to the remaining ISPSC Chapters:

CHAPTER 7 ONGROUND STORABLE RESIDENTIAL SWIMMING POOLS
CHAPTER 8 PERMANENT INGROUND RESIDENTIAL SWIMMING POOLS
CHAPTER 9 PERMANENT RESIDENTIAL SPAS AND PERMANENT RESIDENTIAL EXERCISE SPAS
CHAPTER 10 PORTABLE RESIDENTIAL SPAS AND PORTABLE RESIDENTIAL EXERCISE SPAS

2021 Virginia Residential Code

Course Overview

Chapter 2	• Definitions
Chapters 3 – 9	• Building
Chapter 11	• Energy
Chapters 12 – 23	• Mechanical
Chapter 24	• Fuel Gas
Chapters 25 – 33	• Plumbing
Chapters 34 – 43	• Electrical
Appendices AF and AW	• Radon and 3D

R202 [RB] Grade Floor Emergency Escape and Rescue Opening (EERO)

Change Type: Clarification

- Definitions for emergency escape and rescue openings and grade floor openings have been updated for clarification and to be consistent with the IBC and other I-Codes and **correlate with the reorganization and new text in Section R310.**

GRADE FLOOR EMERGENCY ESCAPE AND RESCUE OPENING. A window or other **An emergency escape and rescue** opening located such that the **sill height bottom** of the **clear** opening is not more than 44 inches above or below the finished ground level adjacent to the opening.

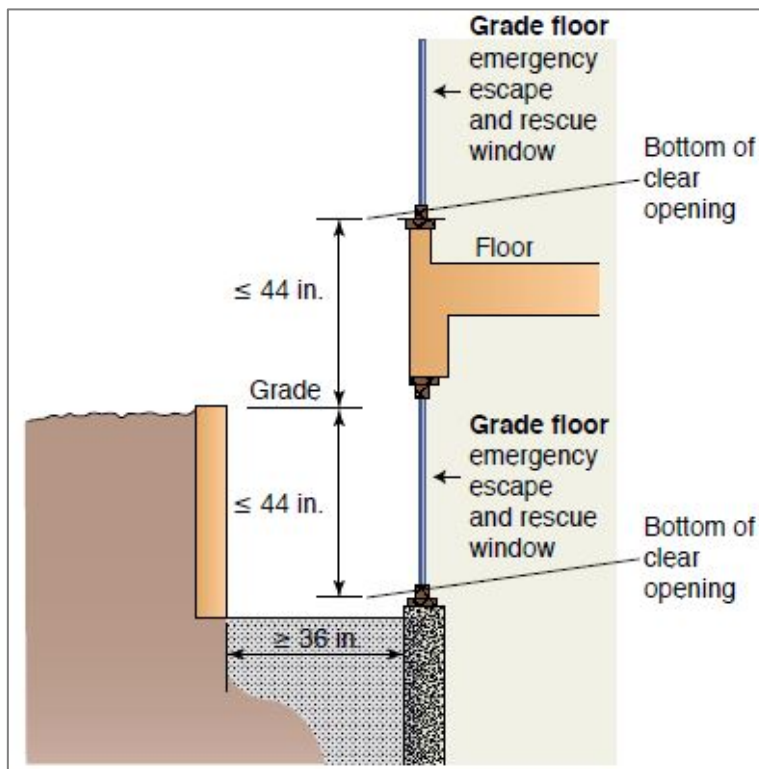

EMERGENCY ESCAPE AND RESCUE OPENING. An operable exterior window, door or **other** similar device that provides for a means of escape and access for rescue in the event of an emergency. (See also “Grade floor emergency escape and rescue opening.”)

R202 [RB]Townhouse and [RB]Townhouse Unit

Change Type: Clarification

- A revised definition of townhouse (a building) and a new definition for townhouse unit (a dwelling unit) clarify the appropriate use of the terms.
- The new terms appear in the **townhouse provisions of Section R302.2** and in other locations throughout the code

BUILDING Any one- or two-family dwelling or townhouse, or portion thereof, ~~including townhouses~~, used or intended to be used for human habitation, for living, sleeping, cooking or eating purposes, or any combination thereof, or any accessory structure. For the definition applicable in Chapter 11, see Section N1101.6.

TOWNHOUSE. Building that contains three or more attached townhouse units.

TOWNHOUSE UNIT. A single-family dwelling unit in a townhouse that extends from foundation to roof and that has a yard or public way on not less than two sides.

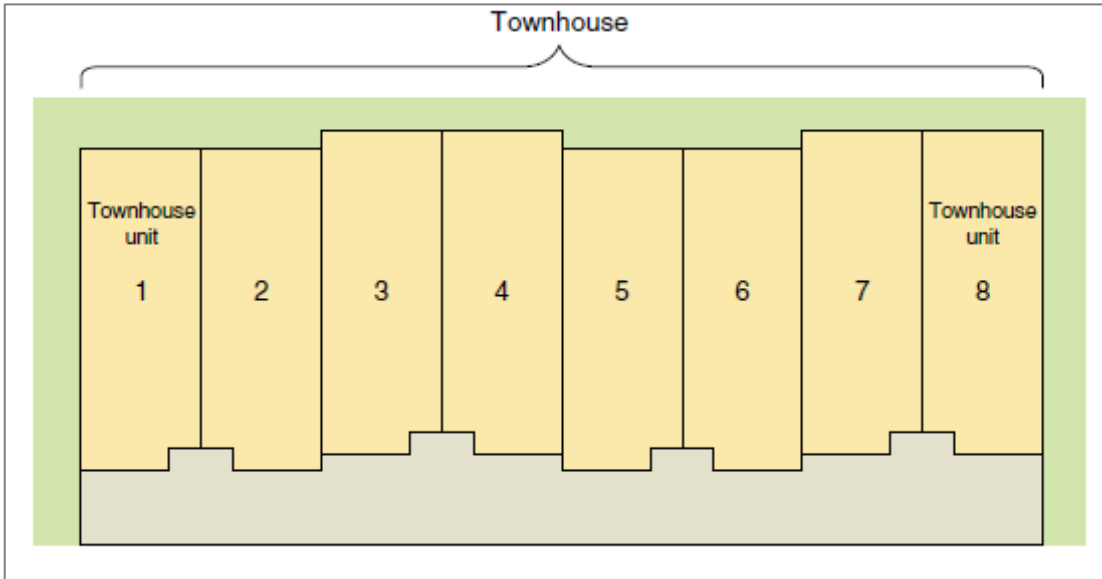

R301.1.4 Intermodal Shipping Containers

Change Type: Addition

- Provisions for construction with intermodal shipping containers are added to the VRC/IRC by referencing the **structural provisions of new VCC/IBC Section 3115**.
- **Additionally, ICC G5 is available for guidance** – *Guideline for the Safe Use of ISO Shipping Containers Repurposed as Buildings and Building Components*.

R301.1.4 Intermodal shipping containers. Intermodal shipping containers that are repurposed for use as buildings or structures, shall be designed in accordance with the structural provisions in Section 3115 of the International Building Code.

OVERVIEW - IBC/VCC SECTION 3115 (not all subsections shown)

SECTION 3115 INTERMODAL SHIPPING CONTAINERS

3115.8 Structural.

3115.8.1 Foundations

3115.8.2 Welds

3115.8.3 Structural Design

3115.8.4 Detailed design procedure

3115.8.5 Simplified structural design of single-unit containers.

TABLE 3115.8.5.3 ALLOWABLE SHEAR VALUES FOR INTERMODAL SHIPPING CONTAINER CORRUGATED STEEL WALLS FOR WIND OR SEISMIC LOADING

FIGURE 3115.8.5.3(1) BRACING UNIT DISTRIBUTION—MAXIMUM LINEAR LENGTH

FIGURE 3115.8.5.3(2) BRACING UNIT DISTRIBUTION—MINIMUM LINEAR LENGTH

FIGURE 3115.8.5.3(3) BRACING UNIT DISTRIBUTION—BOUNDARY ELEMENTS

FIGURE 3115.8.5.3(4) BRACING UNIT DISTRIBUTION—PENETRATION LIMITATIONS

R301.3 Story Height

Change Type: Clarification

- Maximum story height for wood wall framing is 13 feet 7 inches when the exception requirements are met.

Load	Stud Height (feet)		
	≤ 10'	> 10' to ≤ 12'	> 12'
Load Bearing Studs	No engineering required	Engineering required unless an exception in Section R602.3.1 is met: Exc. 2 – snow load and tributary length limit Exc. 3 – snow load and span limits, only Exp B	Engineering always required
Non-loadbearing Studs	No engineering required	No engineering required for 2x4 and larger studs	Engineering required unless limits of Table R602.3(5) are met

The following changes apply to Seismic Design Category C areas only

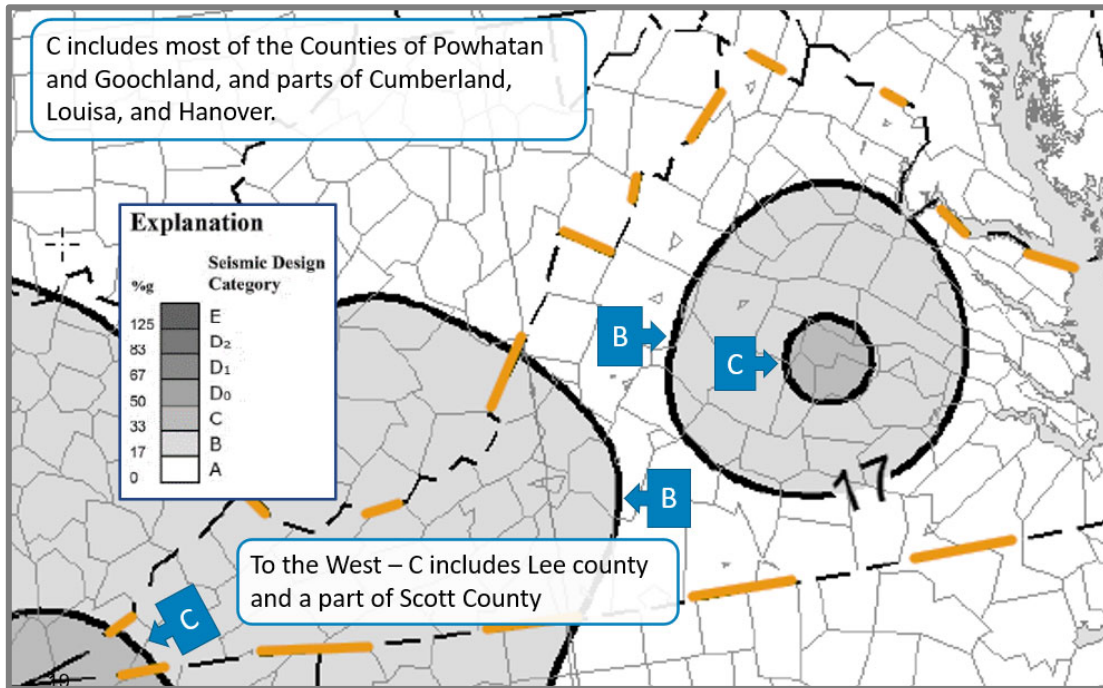

R301.2.2.6 Irregular Buildings Item 8 (SDC C Areas)

Change Type: Addition

- Irregular building requirements for homes in high seismic regions (Seismic Design Categories C, D0, D1 and D2) now include limits for hillside light-frame construction.

R301.2.2.6 Irregular buildings. The seismic provisions of this code shall not be used for structures, or portions thereof, located in Seismic Design Categories C, D0, D1 and D2 and considered to be irregular in accordance with this section. A building or portion of a building shall be considered to be irregular where one or more of the conditions defined in Items 1 through 7 occur. Irregular structures, or irregular portions of structures, shall be designed in accordance with accepted engineering practice to the extent the irregular features affect the performance of the remaining structural system. Where the forces associated with the irregularity are resisted by a structural system designed in accordance with accepted engineering practice, the remainder of the building shall be permitted to be designed using the provisions of this code.

(No changes to Items 1-7)

8. Hillside Light-Frame Construction. Conditions in which all of the following apply:

8.1. The grade slope exceeds 1 vertical in 5 horizontal where averaged across the full length of any side of the dwelling.

8.2. The tallest **cripple wall clear height** exceeds 7 feet (2134 mm), or where a post and beam system occurs at the dwelling perimeter, the post and beam system tallest post clear height exceeds 7 feet (2134 mm).

8.3. Of the total plan area below the lowest framed floor, whether open or enclosed, less than 50 percent is living space having interior wall finishes conforming to Section R702.

Where Item 8 is applicable, design in accordance with accepted engineering practice shall be provided for the floor diaphragm immediately above the cripple walls or post and beam system and all structural elements and connections from this diaphragm down to and including connections to the foundation and design of the foundation to transfer lateral loads from the framing above.

Exception: Light-frame construction in which the lowest framed floor is supported directly on concrete or masonry walls over the full length of all sides except the downhill side of the dwelling need not be considered an irregular dwelling under Item 8.

R202 CRIPPLE WALL CLEAR HEIGHT. The vertical height of a cripple wall from the top of the foundation to the underside of floor framing above.

R301.2.2.10 Anchorage of Water Heaters (SDC C Areas)

Change Type: Modification

- Water heaters and thermal storage units in Townhouses in **Seismic Design Categories C** must be anchored.

R301.2.2.10 Anchorage of water heaters. In Seismic Design Categories D0, D1 and D2, and in townhouses in Seismic Design Category C, water heaters and thermal storage units shall be anchored against movement and overturning in accordance with Section M1307 M1307.2 or P2801.8.

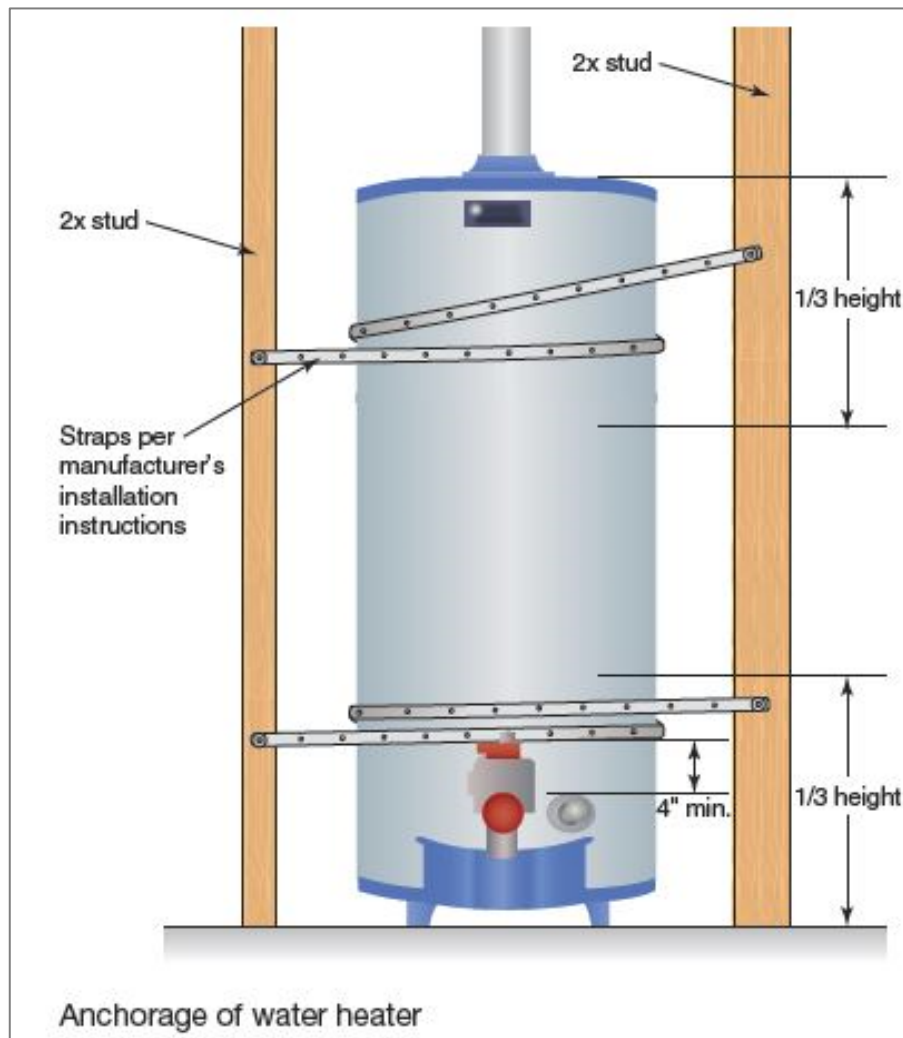

R302.2 Townhouse Common Wall

Change Type: Modification

- Common walls separating townhouses are permitted to terminate at the inside of exterior walls where the prescribed fireblocking is provided (two 2" nominal thickness wood studs).
- Language is also modified to incorporate the new definition of "townhouse unit" and the revised definition of "townhouse" throughout.

R302.2 Townhouses. Walls separating townhouse units shall be constructed in accordance with Section R302.2.1 or R302.2.2 and shall comply with Sections 302.2.3 through 302.2.5.

R302.2.1 Double walls. Each townhouse unit shall be separated from other townhouse units by two 1-hour fire-resistance-rated wall assemblies tested in accordance with ASTM E119, UL 263 or Section ~~703.3~~ 703.2.2 of the *International Building Code*.

R302.2.2 Common walls. Common walls separating ~~townhouses~~ townhouse units shall be assigned a fire-resistance rating in accordance with Item 1 or 2 **[summary of "Item 1 or 2": sprinklered – 1 hour, no sprinklers – 2 hour]** and shall be rated for fire exposure from both sides. Common walls shall extend to and be tight against the exterior sheathing of the exterior walls, or the inside face of exterior walls without stud cavities, and the underside of the roof sheathing. The common wall shared by two ~~townhouses~~ townhouse units shall be constructed without plumbing or mechanical equipment, ducts or vents, other than water-filled fire sprinkler piping, in the cavity of the common wall. ~~The wall shall be rated for fire exposure from both sides and shall extend to and be tight against exterior walls and the underside of the roof sheathing.~~ Electrical installations shall be in accordance with Chapters 34 through 43. Penetrations of the membrane of common walls for electrical outlet boxes shall be in accordance with Section R302.4.

Exception: Common walls are permitted to extend to and be tight against the inside of the exterior walls if the cavity between the end of the common wall and the exterior sheathing is filled with a minimum of two 2-inch nominal thickness wood studs.

R302.2 Townhouse Common Wall, continued

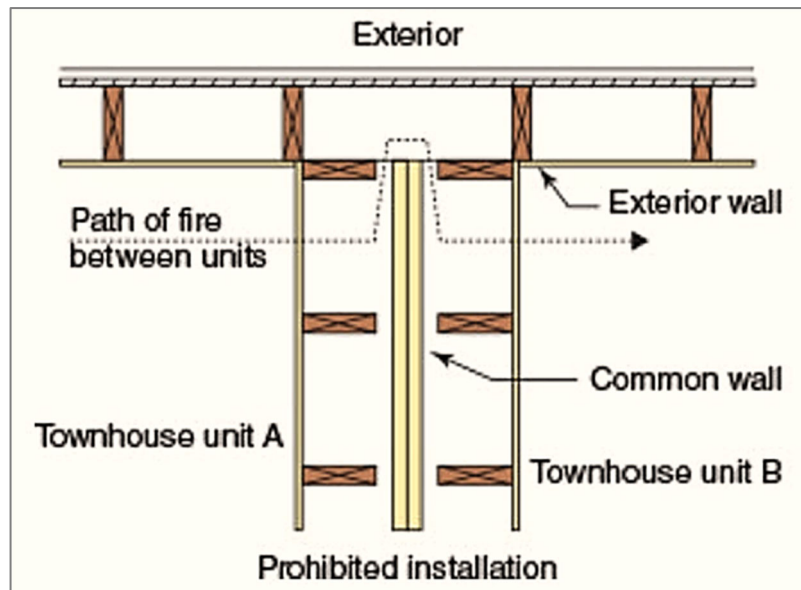
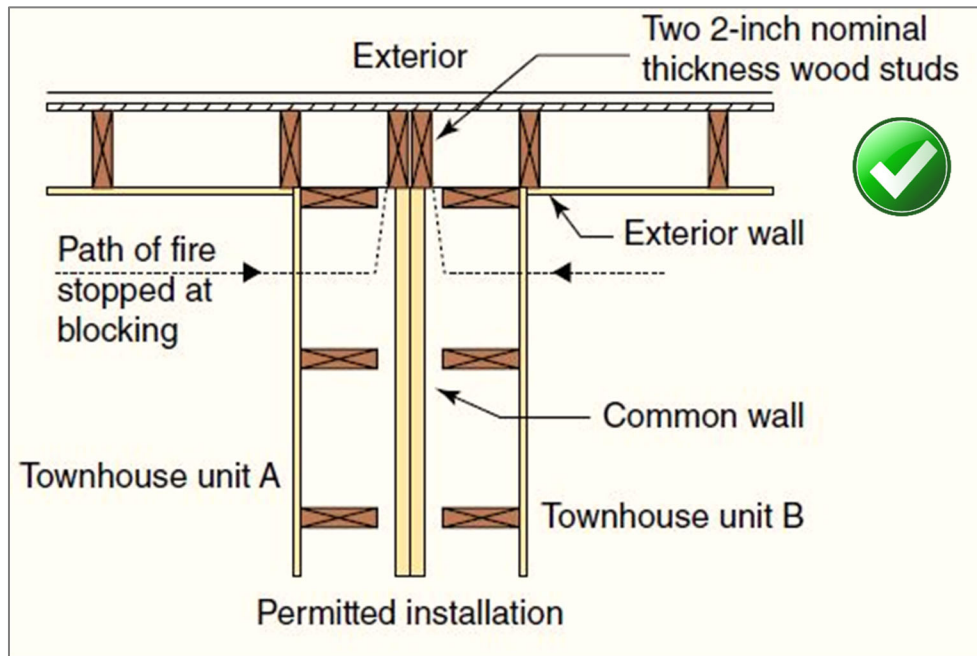

R303.1 Mechanical Ventilation

Change Type: Clarification

- Whole-house mechanical ventilation system or a mechanical ventilation system capable of producing 0.35 ACH in habitable rooms.
- A local exhaust system is an acceptable substitute for natural ventilation in kitchens.

R303.1 Habitable rooms. Habitable rooms shall have an aggregate glazing area of not less than 8 percent of the floor area of such rooms. Natural ventilation shall be through windows, skylights, doors, louvers or other approved openings to the outdoor air. Such openings shall be provided with ready access or shall otherwise be readily controllable by the building occupants. The openable area to the outdoors shall be not less than 4 percent of the floor area being ventilated.

Exceptions:

1. ~~The~~ For habitable rooms other than kitchens, the glazed areas need not be openable where the opening is not required by Section R310 and a whole-house mechanical ventilation system or a mechanical ventilation system capable of producing 0.35 air changes per hour in the habitable rooms is installed in accordance with Section M1505.

2. For kitchens, the glazed areas need not be openable where the opening is not required by Section R310 and a local exhaust system is installed in accordance with Section M1505.

~~2-~~ 3. The glazed areas need not be installed in rooms where Exception 1 is satisfied and artificial light is provided that is capable of producing an average illumination of 6 footcandles (65 lux) over the area of the room at a height of 30 inches (762 mm) above the floor level.

~~3-~~ 4. Use of sunroom and patio covers, as defined in Section R202, shall be permitted for natural ventilation if in excess of 40 percent of the exterior sunroom walls are open, or are enclosed only by insect screening.

R303.4 Mechanical ventilation. ~~Where the air infiltration rate of a dwelling unit is 5 air changes per hour or less where tested with a blower door at a pressure of 0.2 inch w.c. (50 Pa) in accordance with Section N1102.4.1.2, the dwelling unit~~ Buildings and dwelling units complying with Section N1102.4.1 shall be provided with whole-house mechanical ventilation in accordance with Section M1505, or with other approved means of ventilation.

R305.1 Ceiling Height

Change Type: Modification

- Minimum ceiling height is reduced to 6 ft. 6 in. under beams spaced at least 36 in. apart.

R305.1 Minimum height. Habitable space, hallways and portions of basements containing these spaces shall have a ceiling height of not less than 7 feet (2134 mm). Bathrooms, toilet rooms and laundry rooms shall have a ceiling height of not less than 6 feet 8 inches (2032 mm).

Exceptions:

1. For rooms with sloped ceilings, the required floor area of the room shall have a ceiling height of not less than 5 feet (1524 mm) and not less than 50 percent of the required floor area shall have a ceiling height of not less than 7 feet (2134 mm).

2. The ceiling height above bathroom and toilet room fixtures shall be such that the fixture is capable of being used for its intended purpose. A shower or tub equipped with a showerhead shall have a ceiling height of not less than 6 feet 8 inches (2032 mm) above an area of not less than 30 inches (762 mm) by 30 inches (762 mm) at the showerhead.

3. Beams, girders, ducts or other obstructions in basements containing habitable space shall be permitted to project to within 6 feet 4 inches (1931 mm) of the finished floor.

4. Beams and girders spaced apart not less than 36 inches (914 mm) in clear finished width shall project not more than 78 inches (1981 mm) from the finished floor.

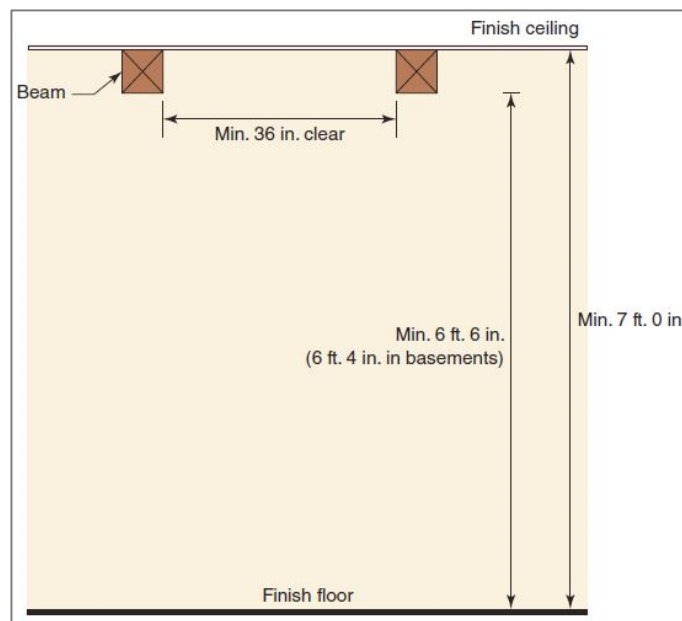

R310.1 Emergency Escape and Rescue Opening Required

Change Type: Clarification

- Emergency escape and rescue openings require an unobstructed 36-inch-wide path to a public way.
- Operation requirements have been clarified.

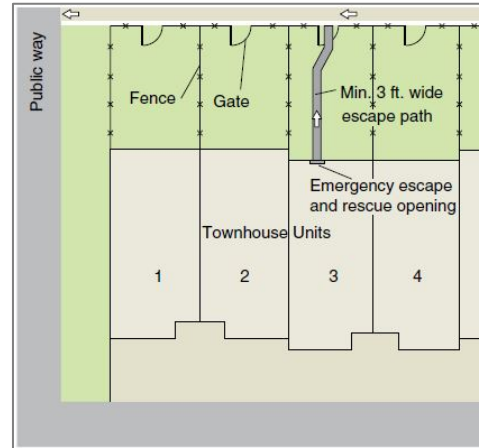

R310.1 Emergency escape and rescue opening required. Basements, habitable attics and every sleeping room shall have not less than one operable emergency escape and rescue opening. Where basements contain one or more sleeping rooms, an emergency escape and rescue opening shall be required in each sleeping room. Emergency escape and rescue openings shall open directly into a public way, or to a yard or court **having a minimum width of 36 inches (914 mm)** that opens to a public way.

Exceptions:

1. Storm shelters and basements used only to house mechanical equipment not exceeding a total floor area of 200 square feet (18.58 m²).
2. Where the dwelling unit or townhouse unit is equipped with an automatic sprinkler system installed in accordance with Section P2904, sleeping rooms in basements shall not be required to have emergency escape and rescue openings provided that the basement has one of the following:
 - 2.1. One means of egress complying with Section R311 and one emergency escape and rescue opening.
 - 2.2. Two means of egress complying with Section R311.
3. **A yard shall not be required to open directly into a public way where the yard opens to an unobstructed path from the yard to the public way. Such path shall have a width of not less than 36 inches (914 mm).**

R310.1.1 Operational constraints and opening control devices. Emergency escape and rescue openings shall be operational from the inside of the room without the use of keys, tools or special knowledge. Window opening control devices **and fall prevention devices complying with ASTM F2090 shall be permitted for use** on windows serving as a required emergency escape and rescue opening **and shall be not more than 70 inches (178 cm) above the finished floor** shall comply with ASTM F2090.

R310.2.4 Emergency Escape and Rescue Openings

Change Type: Modification

- Emergency escape openings under decks, porches and cantilevers require a path not less than 36 in. in height and 36 in. in width.

R310.2.4 Emergency escape and rescue openings under decks, porches and cantilevers. Emergency escape and rescue openings installed under decks, porches and cantilevers shall be fully openable and provide a path not less than 36 inches (914 mm) in height and 36 inches (914 mm) in width to a yard or court.

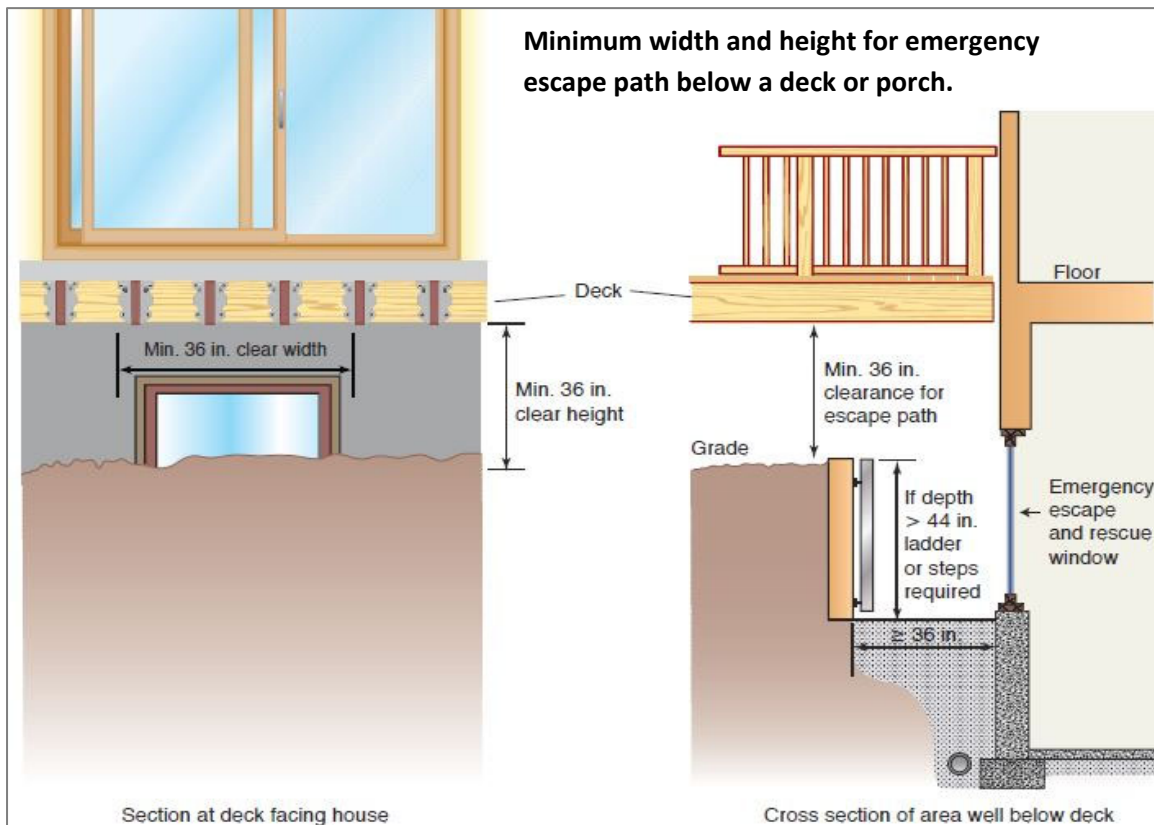

R310.3, R310.4 Area Wells for EERO

Change Type: Modification

- The provisions for window wells and area wells serving emergency escape and rescue openings have been merged into one section for area wells (R310.4).
- Dimensions are given for steps:
 - 5 in. tread
 - 18 in. rise
 - 12 in. width

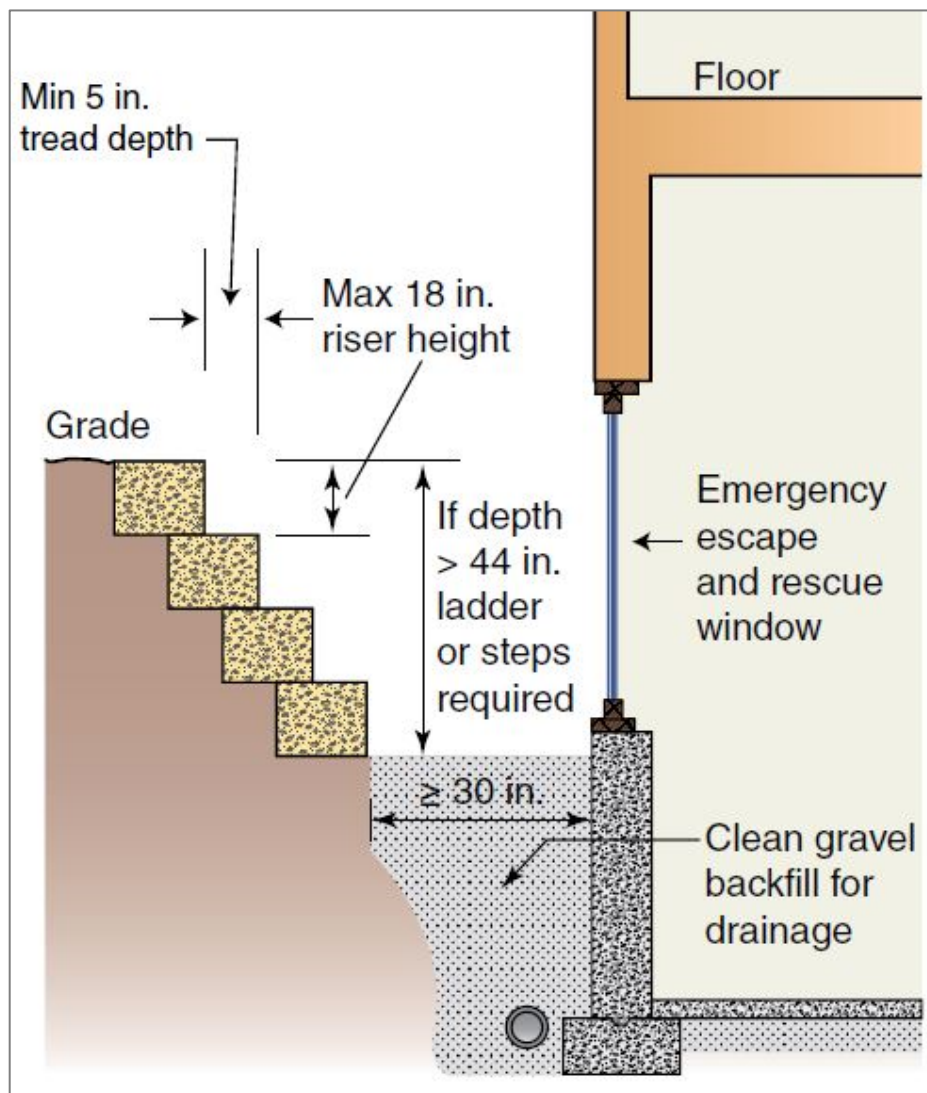

R310.5, R310.6, R310.7 EERO in Existing Buildings

Change Type: Modification

- A 4 sq. ft. clear opening for EERO is acceptable for a basement remodel, basement addition, and for a change of occupancy

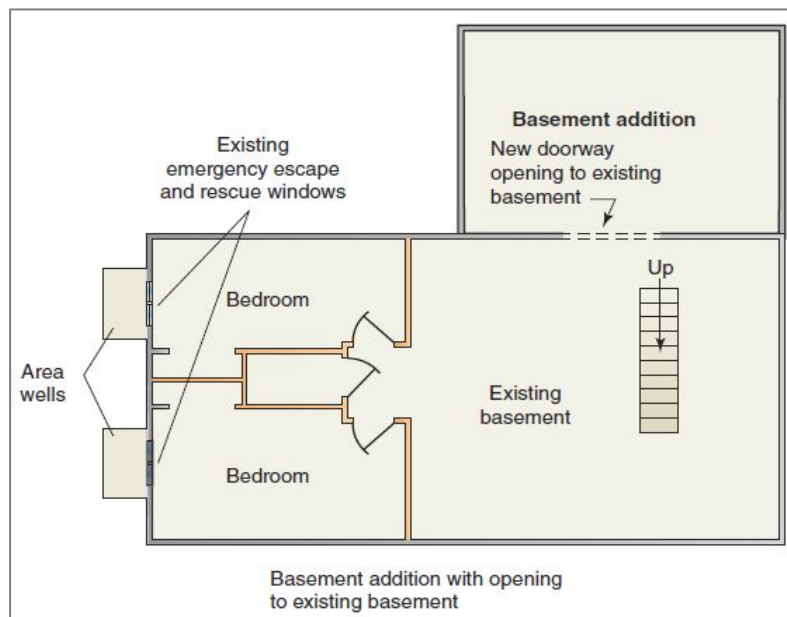
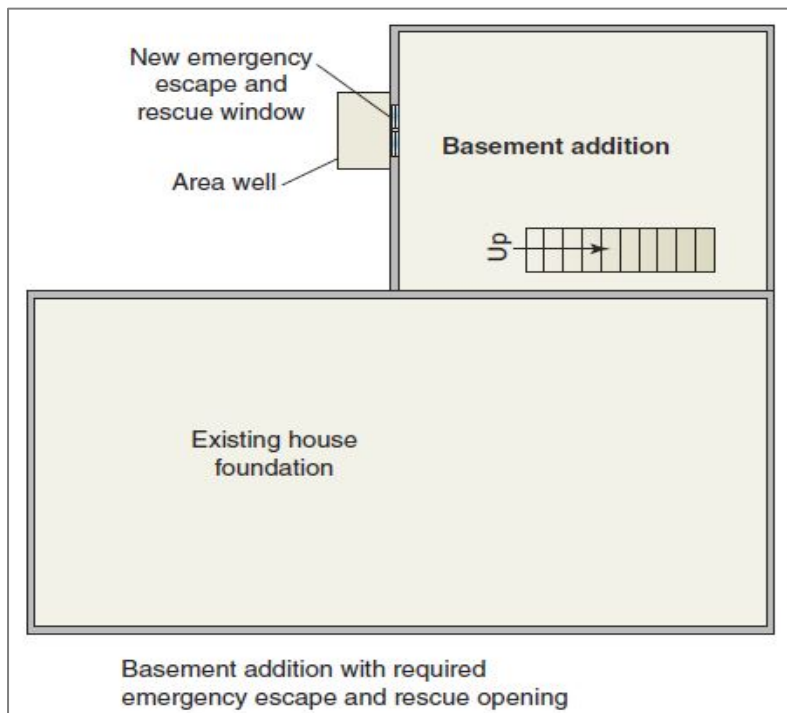

R311.7, R311.8 Stairways and Ramps

Change Type: Clarification

- The provisions of Sections R311.7 and R311.8 apply only to stairways and ramps within or serving a building, porch or deck.

R202 STAIRWAY. One or more flights of stairs, either interior or exterior, with the necessary landings and connecting platforms to form a continuous and uninterrupted passage from one level to another ~~within or attached to a building, porch or deck.~~

R311.7 Stairways. Where required by this code or provided, stairways shall comply with this section.

Exceptions:

- 1. Stairways not within or serving a building, porch or deck**
- 2. Stairways leading to non-habitable attics**
- 3. Stairways leading to crawl spaces.**

R311.8 Ramps.

Where required by this code or provided, ramps shall comply with this section.

Exception: Ramps not within or attached to a building, porch or deck.

(Subsections not shown)

R311.7.7 Stairway and Landing Walking Surface

Change Type: Modification

- New exception allows steeper slopes for exterior landings that also serve to drain surface water away from the building.

R311.7.7 Stairway walking surface. The walking surface of treads and landings of stairways shall be sloped not steeper than one unit vertical in 48 inches units horizontal (2-percent slope).

Exception: Where the surface of a landing is required elsewhere in the code to drain surface water, the walking surface of the landing shall be sloped not steeper than 1 unit vertical in 20 units horizontal (5-percent slope) in the direction of travel.

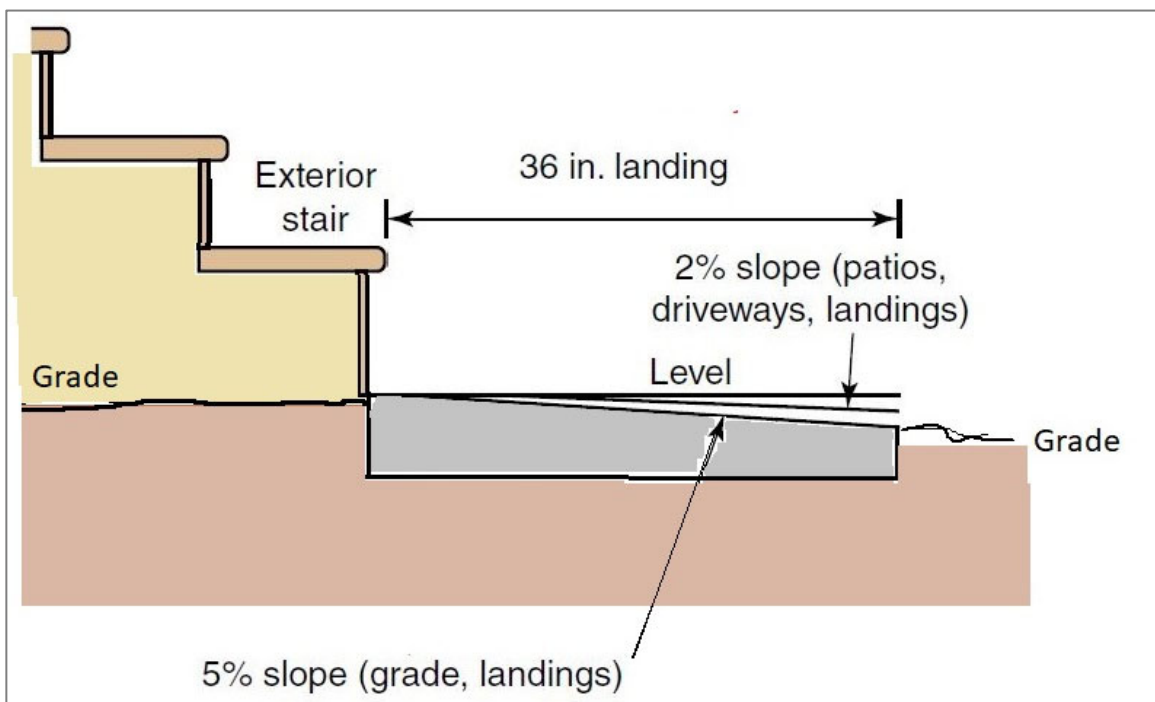

R314.3 Smoke Alarm Locations

Change Type: Modification

- A new location requirement addresses high ceilings adjacent to hallways serving bedrooms.

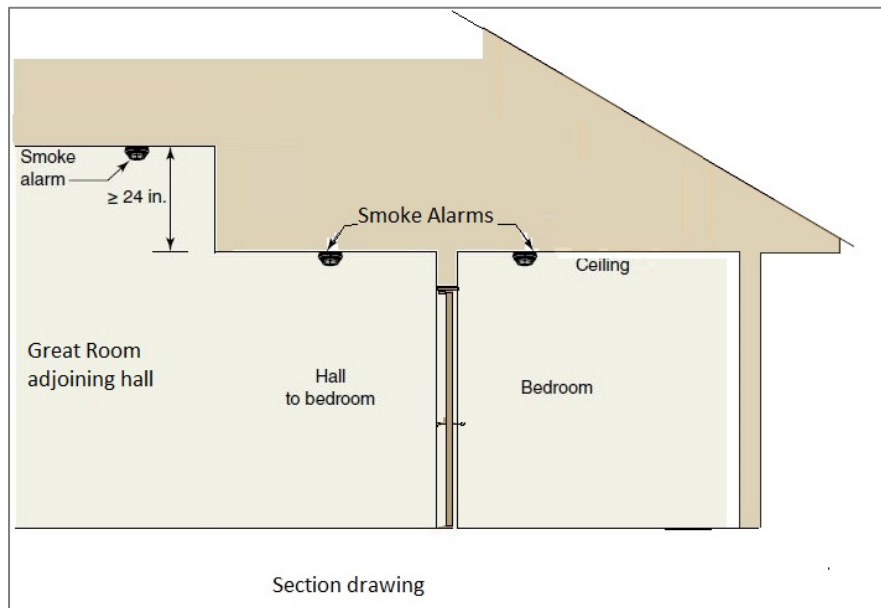

R314.3 Location. Smoke alarms shall be installed in the following locations:

1. In each sleeping room.
2. Outside each separate sleeping area in the immediate vicinity of the bedrooms.
3. On each additional story of the dwelling, including basements and habitable attics and not including crawl spaces and uninhabitable attics. In dwellings or dwelling units with split levels and without an intervening door between the adjacent levels, a smoke alarm installed on the upper level shall suffice for the adjacent lower level provided that the lower level is less than one full story below the upper level.
4. Not less than 3 feet (914 mm) horizontally from the door or opening of a bathroom that contains a bathtub or shower unless this would prevent placement of a smoke alarm required by this section.
5. **In the hallway and in the room open to the hallway in dwelling units where the ceiling height of a room open to a hallway serving bedrooms exceeds that of the hallway by 24 inches (610 mm) or more.**

R314.3.1 Smoke Alarms Near Cooking Appliances



Change Type: Modification

- Smoke alarms identified as having resistance to common nuisance alarms from cooking sources are now permitted to be as close as 6 feet from the cooking appliance.

R314.3.1 Installation near cooking appliances. Smoke alarms shall not be installed in the following locations unless this would prevent placement of a smoke alarm in a location required by Section R314.3.

1. Ionization smoke alarms shall not be installed less than 20 feet (6096 mm) horizontally from a permanently installed cooking appliance.
2. Ionization smoke alarms with an alarm-silencing switch shall not be installed less than 10 feet (3048 mm) horizontally from a permanently installed cooking appliance.
3. Photoelectric smoke alarms shall not be installed less than 6 feet (1828 mm) horizontally from a permanently installed cooking appliance.
4. **Smoke alarms listed and marked “helps reduce cooking nuisance alarms” shall not be installed less than 6 feet (1828 mm) horizontally from a permanently installed cooking appliance.**

R317.1 Protection of Wood against Decay

Change Type: Clarification

- The provisions of Section R317.1 have been revised and reorganized for clarification.

R317.1 Location required. Protection of wood and wood-based products from decay shall be provided in the following locations by the use of naturally durable wood or wood that is preservative-treated in accordance with AWPA U1.

1. ~~Wood joists or the bottom of a wood structural floor where closer than 18 inches (457 mm) or, wood girders where closer than 12 inches (305 mm) to the exposed ground, in in crawl spaces or unexcavated area located within the periphery of the building foundation, wood joists or the bottom of a wood structural floor where closer than 18 inches (457 mm) to exposed ground, wood girders where closer than 12 inches (305 mm) to exposed ground, and wood columns where closer than 8 inches (204 mm) to exposed ground.~~
 2. Wood framing members, including columns, that rest directly on concrete or masonry exterior foundation walls and are less than 8 inches (203 mm) from the exposed ground.
- [Items 3 – 7 are unchanged]**
8. Portions of wood structural members that form the structural supports of buildings, balconies, porches or similar permanent building appurtenances where those members are exposed to the weather without adequate protection from a roof, eave, overhang or other covering that would prevent moisture or water accumulation on the surface or at joints between members.
Exception: Sawn lumber used in buildings located in a geographical region where experience has demonstrated that climatic conditions preclude the need to use naturally durable or preservative-treated wood where the structure is exposed to the weather.
 9. Wood columns in contact with basement floor slabs unless supported by concrete piers or metal pedestals projecting at least 1 inch (25 mm) above the concrete floor and separated from the concrete pier by an impervious moisture barrier.

R317.1.1 Field treatment. [No change]

R317.1.2 Ground contact. [No change]

R317.1.3 Geographical areas.

~~R317.1.4 Wood columns. Wood columns shall be approved wood of natural decay resistance or approved pressure-preservative-treated wood.~~

Exceptions:

R320 Accessibility

Change Type: Modification

- Clarifies accessibility provisions for live/work units and owner-occupied lodging houses (B&Bs)
 - Accessibility is typically not required for VRC buildings.

LIVE/WORK UNIT. A dwelling unit or sleeping unit in which a significant portion of the space includes a nonresidential use that is operated by the tenant.

SLEEPING UNIT. A single unit that provides rooms or spaces for one or more persons, includes permanent provisions for sleeping and can include provisions for living, eating and either sanitation or kitchen facilities but not both. Such rooms and spaces that are also part of a dwelling unit are not sleeping units.

R322 Flood Hazard Areas

Change Type: VA Modification/Addition (proposal RB202-21)

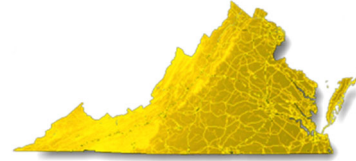

- These flood hazard area related changes are from the Resiliency sub-workgroup
- The new definition and related changes align with the National Flood Insurance Program (NFIP).

202 FLOOD HAZARD AREA. The greater of the following two areas:

1. The area within a floodplain subject to a 1-percent or greater chance of flooding in any given year (also known as the 100-year floodplain).
2. The area designated as a flood hazard area on a community's flood hazard map, or otherwise legally designated, including areas shown in either the Flood Insurance Study or on the Flood Insurance Rate Map (FIRM) and including areas added to account for future flooding conditions based on the locally adopted sea level rise projected to occur by 2070.

Summary of changes

- **322.1.5 Lowest floor** - limited storage defined as 200 sq ft or less
- **322.1.8 Flood-resistant materials** - adds ACSE 24 to requirements
- **322.2 Flood hazard areas** (including A Zones) - Simplifies wave height requirement (≥ 1.5 ft or otherwise designate by the *jurisdiction*) and adds options for V, VE, and V1-30 zones
- **322.2.1 Elevation requirements** - Adds flood resistant materials requirement for garages and carports.
- **R322.3.1 Location and site preparation** - New FEMA letter requirement for alteration of sand dunes and mangrove stands
- **R322.3.6 Enclosed areas below required elevation** - Prohibited in Coastal A Zones and Coastal High Hazard Areas
- **R322.3.10 Tanks** - Underground tanks prohibited in Coastal A Zones and Coastal High Hazard Areas

R323.1.1 Storm Shelters

Change Type: Addition

- Added guidance on the design of storm shelters is placed in Section R323.
- Storm Shelter definition also added.

STORM SHELTER. A building, structure or portion thereof, constructed in accordance with ICC 500 and designated for use during a severe windstorm event, such as a hurricane or tornado.

SECTION R323 STORM SHELTERS

R323.1 General. This section applies to storm shelters where constructed as separate detached buildings or where constructed as safe rooms within buildings for the purpose of providing refuge from storms that produce high winds, such as tornados and hurricanes. In addition to other applicable requirements in this code, storm shelters shall be constructed in accordance with ICC/NSSA-500.

R323.1.1 Sealed documentation. The construction documents for all structural components and impact protective systems of the storm shelter shall be prepared and sealed by a registered design professional indicating that the design meets the criteria of ICC-500.

Exception: Storm shelters, structural components and impact-protective systems that are listed and labeled to indicate compliance with ICC-500.

R324.6 Photovoltaic Systems

Change Type: Modification

- Building-integrated photovoltaic (BIPV) systems meeting the specified criteria do not require firefighter access pathways and setbacks.

R324.6 Roof access and pathways. Roof access, pathways and setback requirements shall be provided in accordance with Sections R324.6.1 through R324.6.2.1. Access and minimum spacing shall be required to provide emergency access to the roof, to provide pathways to specific areas of the roof, provide for smoke ventilation opportunity areas, and to provide emergency egress from the roof.

Exceptions:

1. Detached, nonhabitable structures, including but not limited to detached garages, parking shade structures, carports, solar trellises and similar structures, shall not be required to provide roof access.
2. Roof access, pathways and setbacks need not be provided where the code official has determined that rooftop operations will not be employed.
3. These requirements shall not apply to roofs with slopes of two units vertical in 12 units horizontal (17-percent slope) or less.
4. **BIPV systems listed in accordance with Section 690.12(B)(2) of NFPA 70, where the removal or cutting away of portions of the BIPV system during firefighting operations have been determined to not expose a firefighter to electrical shock hazards.**

~~R324.6.2.2~~ R324.6.3 Emergency escape and rescue openings. Panels and modules installed on dwellings shall not be placed on the portion of a roof that is below an emergency escape and rescue opening. A pathway not less than 36 inches (914 mm) wide shall be provided to the emergency escape and rescue opening.

Exception: BIPV systems listed in accordance with Section 690.12(B)(2) of NFPA 70, where the removal or cutting away of portions of the BIPV system during firefighting operations have been determined to not expose a firefighter to electrical shock hazards.

R324.6.2 Setback at Ridge

Change Type: VA Modification (proposal RB324.6.2-21)

- This change greatly simplifies the requirements for setbacks at a horizontal ridge into one sentence.

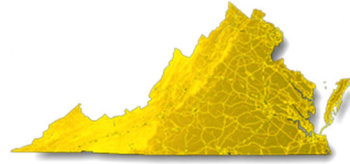

VRC R324.6.2 Setback at ridge.

~~For photovoltaic arrays occupying not more than 33 percent of the plan view total roof area, **Not less than an 18-inch (457 mm) clear setback is required on both sides of a horizontal ridge.** For photovoltaic arrays occupying more than 33 percent of the plan view total roof area, not less than a 36-inch (914 mm) clear setback is required on both sides of a horizontal ridge.~~

R324.6.2.1 Alternative setback at ridge.

~~Where an automatic sprinkler system is installed within the dwelling in accordance with NFPA 13D or Section P2904, setbacks at ridges shall comply with one of the following:~~

- ~~1. For photovoltaic arrays occupying not more than 66 percent of the plan view total roof area, not less than an 18-inch (457 mm) clear setback is required on both sides of a horizontal ridge.~~
- ~~2. For photovoltaic arrays occupying more than 66 percent of the plan view total roof area, not less than a 36-inch (914 mm) clear setback is required on both sides of a horizontal ridge.~~

R326 Habitable Attics

Change Type: VA Modification (proposal RB326-21)

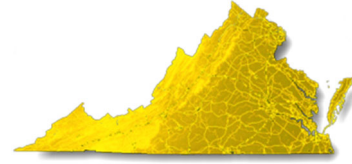

- Virginia deletes the technical requirements from the definition and incorporates the VA-specific requirements in updated section R326.
- Does not change any requirements or how habitable attics are enforced in Virginia.

VRC R326.3 Story above grade plane.

A habitable attic shall be considered a story above grade plane.

Exception: A habitable attic shall not be considered to be a story above grade plane provided that the habitable attic meets all the following:

1. The aggregate area of the habitable attic is not greater than two-thirds of the floor area of the story below OR a maximum of 400 sq ft.
2. The occupiable space is enclosed by the roof assembly above, knee walls, if applicable, on the sides and the floor-ceiling assembly below.

R333.1 Sound Transmission between Dwelling Units

Change Type: VA Modification (proposal RB330.1-21)

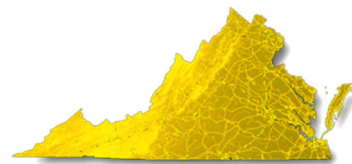

- Adds an exception to the sound insulation requirements for Accessory Dwelling Units (ADUs).

R330.1 Sound transmission between dwelling units.

Construction assemblies separating *dwelling units* shall provide airborne sound insulation as required in Appendix K.

Exception: *accessory dwelling units*

Table R403.1(1) Footing Width and Thickness

Change Type: Modification

- Minimum footing size tables are revised to more accurately reflect current practice.

Table Excerpt

Ground Snow Load or Roof Live Load	Story and Type of Structure with Light Frame	Load Bearing Value of Soil (psf)					
		1500	2000	2500	3000	3500	4000
20 psf Roof Live Load or 25 psf Ground Snow Load	1 story - slab on grade	12x6	12x6	12x6	12x6	12x6	12x6
	1 story - with crawl space	12x6	12x6	12x6	12x6	12x6	12x6
	1 story - plus basement	16x6 18x6	12x6 14x6	12x6	12x6	12x6	12x6
	2 story - slab on grade	13x6 12x6	12x6	12x6	12x6	12x6	12x6
	2 story - with crawl space	15x6 16x6	12x6	12x6	12x6	12x6	12x6
	2 story - plus basement	19x6 22x6	14x6 16x6	12x6 13x6	12x6	12x6	12x6
30 psf	1 story - slab on grade	12x6	12x6	12x6	12x6	12x6	12x6
	1 story - with crawl space	13x6	12x6	12x6	12x6	12x6	12x6
	1 story - plus basement	16x6 19x6	12x6 14x6	12x6	12x6	12x6	12x6
	2 story - slab on grade	13x6 12x6	12x6	12x6	12x6	12x6	12x6
	2 story - with crawl space	16x6 17x6	12x6 13x6	12x6	12x6	12x6	12x6
	2 story - plus basement	19x6 23x6	14x6 17x6	12x6 14x6	12x6	12x6	12x6

R406.2 Foundation Waterproofing

Change Type: Deletion

- Six-mil polyvinyl chloride and polyethylene fabrics are removed from the list of approved waterproofing materials.

R406.2 Concrete and masonry foundation waterproofing. In areas where a high water table or other severe soil-water conditions are known to exist, exterior foundation walls that retain earth and enclose interior spaces and floors below grade shall be waterproofed from the higher of (a) the top of the footing or (b) 6 inches (152 mm) below the top of the basement floor, to the finished grade. Walls shall be waterproofed in accordance with one of the following:

1. Two-ply hot-mopped felts.
2. Fifty-five-pound (25 kg) roll roofing.
- ~~3. Six-mil (0.15 mm) polyvinyl chloride.~~
- ~~4. Six-mil (0.15 mm) polyethylene.~~
3. Forty-mil (1 mm) polymer-modified asphalt.
4. Sixty-mil (1.5 mm) flexible polymer cement.
5. One-eighth inch (3 mm) cement-based, fiber-reinforced, waterproof coating.
6. Sixty-mil (1.5 mm) solvent-free liquid-applied synthetic rubber.

All joints in membrane waterproofing shall be lapped and sealed with an adhesive compatible with the membrane.

Exception: Organic-solvent-based products such as hydrocarbons, chlorinated hydrocarbons, ketones and esters shall not be used for ICF walls with expanded polystyrene form material. Use of plastic roofing cements, acrylic coatings, latex coatings, mortars and pargings to seal ICF walls is permitted. Cold-setting asphalt or hot asphalt shall conform to Type C of ASTM D449. Hot asphalt shall be applied at a temperature of less than 200°F (93°C).

R506.2.3 Vapor Retarders under Concrete Slabs

Change Type: Modification

- Minimum thickness of required vapor retarders below floor slabs has increased from 6 mil to 10 mil

R506.2.3 Vapor retarder. A ~~minimum 6-mil~~ 10-mil (0.006-0.010 inch; ~~152 mm~~ 0.254 mm) ~~polyethylene or approved~~ vapor retarder conforming to ASTM E1745 Class A requirements with joints lapped not less than 6 inches (152 mm) shall be placed between the concrete floor slab and the base course or the prepared subgrade where a base course does not exist.

Exception: The vapor retarder is not required for the following:

1. Garages, utility buildings and other unheated accessory structures.
2. For unheated storage rooms having an area of less than 70 square feet (6.5 m) and carports.
3. Driveways, walks, patios and other flatwork not likely to be enclosed and heated at a later date.
4. Where approved by the building official, based on local site conditions.

R507.3 Deck Footings

- Footings for freestanding decks on or near the ground have been clarified.

R507.3 Footings. Decks shall be supported on concrete footings or other approved structural systems designed to accommodate all loads in accordance with Section R301. Deck footings shall be sized to carry the imposed loads from the deck structure to the ground as shown in Figure R507.3. ~~The footing depth shall be in accordance with Section R403.1.4.~~

Exceptions:

1. Footings shall not be required for free ~~Free~~-standing decks consisting of joists directly supported on grade over their entire length.
2. Footings shall not be required for freestanding decks that meet all of the following criteria:
 - 2.1 The joists bear directly on precast concrete pier blocks at grade without support by beams or posts.
 - 2.2 The area of the deck does not exceed 200 square feet (18.6 m²).
 - 2.3 The walking surface is not more than 20 inches (508 mm) above grade at any point within 36 inches (914 mm) measured horizontally from the edge.

Table R507.3.1 Minimum Footing Size for Decks

Change Type: Modification

- Table R507.3.1, minimum footing size for decks, is expanded to offer a minimum footing size decreased from a 12-inch by 12-inch square in the 2018 VRC/IRC to a smaller 7-inch by 7-inch square or 8-inch round footing in the 2021 VRC/IRC based on a new 5 psf tributary area.

Table Excerpt (2000 psf and ≥ 3000 psf columns not shown)

LIVE OR GROUND SNOW LOAD (psf)	TRIBUTARY AREA (sq. ft.)	SOIL BEARING CAPACITY		
		1500 psf		
		Side of a square footing (inches)	Diameter of a round footing (inches)	Thickness (inches)
40	5	7	8	6
	20	10	12	6
	40	14	16	6
50	5	7	8	6
	20	11	13	6
	40	15	17	6
60	5	7	8	6
	20	12	14	6
70	5	7	8	6
	20	12	14	6

R507.4 Deck Posts

Change Type: Modification

- The deck post height table is expanded by adding the tributary area supported by a post and the wood species for determination of maximum post height.

<u>Loads</u> <u>(psf)</u>	<u>Post</u> <u>Species</u>	<u>Post</u> <u>Size</u>	<u>Tributary Area (ft²)</u>							
			<u>20</u>	<u>40</u>	<u>60</u>	<u>80</u>	<u>100</u>	<u>120</u>	<u>140</u>	<u>160</u>
			<u>Maximum Deck Post Height (feet-inches)</u>							
<u>40 live</u> <u>load</u>	<u>Southern</u> <u>Pine</u>	<u>4 × 4</u>	<u>14-0</u>	<u>13-8</u>	<u>11-0</u>	<u>9-5</u>	<u>8-4</u>	<u>7-5</u>	<u>6-9</u>	<u>6-2</u>
		<u>4 × 6</u>	<u>14-0</u>	<u>14-0</u>	<u>13-11</u>	<u>12-0</u>	<u>10-8</u>	<u>9-8</u>	<u>8-10</u>	<u>8-2</u>
		<u>6 × 6</u>	<u>14-0</u>	<u>14-0</u>	<u>14-0</u>	<u>14-0</u>	<u>14-0</u>	<u>14-0</u>	<u>14-0</u>	<u>14-0</u>
		<u>8 × 8</u>	<u>14-0</u>	<u>14-0</u>	<u>14-0</u>	<u>14-0</u>	<u>14-0</u>	<u>14-0</u>	<u>14-0</u>	<u>14-0</u>
	<u>Douglas Fir,</u> <u>Hem-fir,</u> <u>SPF</u>	<u>4 × 4</u>	<u>14-0</u>	<u>13-6</u>	<u>10-10</u>	<u>9-3</u>	<u>8-0</u>	<u>7-0</u>	<u>6-2</u>	<u>5-3</u>
		<u>4 × 6</u>	<u>14-0</u>	<u>14-0</u>	<u>13-10</u>	<u>11-10</u>	<u>10-6</u>	<u>9-5</u>	<u>8-7</u>	<u>7-10</u>
		<u>6 × 6</u>	<u>14-0</u>	<u>14-0</u>	<u>14-0</u>	<u>14-0</u>	<u>14-0</u>	<u>14-0</u>	<u>14-0</u>	<u>14-0</u>
		<u>8 × 8</u>	<u>14-0</u>	<u>14-0</u>	<u>14-0</u>	<u>14-0</u>	<u>14-0</u>	<u>14-0</u>	<u>14-0</u>	<u>14-0</u>
	<u>Redwood,</u> <u>W. Cedars,</u> <u>Pond. Pine,</u> <u>Red Pine</u>	<u>4 × 4</u>	<u>14-0</u>	<u>13-2</u>	<u>10-3</u>	<u>8-1</u>	<u>5-8</u>	<u>NP</u>	<u>NP</u>	<u>NP</u>
		<u>4 × 6</u>	<u>14-0</u>	<u>14-0</u>	<u>13-6</u>	<u>11-4</u>	<u>9-9</u>	<u>8-4</u>	<u>6-9</u>	<u>4-7</u>
		<u>6 × 6</u>	<u>14-0</u>	<u>14-0</u>	<u>14-0</u>	<u>14-0</u>	<u>14-0</u>	<u>14-0</u>	<u>13-7</u>	<u>9-7</u>
		<u>8 × 8</u>	<u>14-0</u>	<u>14-0</u>	<u>14-0</u>	<u>14-0</u>	<u>14-0</u>	<u>14-0</u>	<u>14-0</u>	<u>14-0</u>

R507.10 Exterior Guards

Change Type: Addition

- Requirements for deck guardrails are added.
- Provisions mirror requirements for interior stairway ramp guards.
- Two methods to connect guards – to side or top of deck framing.

R507.10 Exterior guards. Guards shall be constructed to meet the requirements of Sections R301.5 and R312 and this section.

R507.10.1 Support of guards. Where guards are supported on deck framing, guard loads shall be transferred to the deck framing with a continuous load path to the deck joists.

R507.10.1.1 Guards supported by side of deck framing. Where guards are connected to the interior or exterior side of a deck joist or beam, the joist or beam shall be connected to the adjacent joists to prevent rotation of the joist or beam. Connections relying only on fasteners in end grain withdrawal are not permitted.

R507.10.1.2 Guards supported on top of deck framing. Where guards are mounted on top of the decking, the guards shall be connected to the deck framing or blocking and installed in accordance with manufacturer's instructions to transfer the guard loads to the adjacent joists.

R507.10.2 Wood posts at deck guards. Where 4-inch by 4-inch (102 mm by 102 mm) wood posts support guard loads applied to the top of the guard, such posts shall not be notched at the connection to the supporting structure.

R507.10.3 Plastic composite guards. Plastic composite guards shall comply with the provisions of Section R507.2.2.

R507.10.4 Other guards. Other guards shall be in accordance with manufacturer's instructions or in accordance with accepted engineering principles.

Table R602.3(1) Fasteners – Roof and Wall

Change Type: Modification

- Additional fastener options are added to the fastener table for roof and walls.
- The required nailing of the first full-height stud adjacent to a header is added to the fastening schedule table in Item 12 for wall connections, where it can be located quickly.

Item	Description of Building Elements	Number and Type of Fastener	Spacing and Location
Roof			
1	<u>Blocking between ceiling joists or rafters or trusses to top plate or other framing below</u>	4-8d box (2½" x 0.113") nails 3-8d common (2½" x 0.131") nails 3-10d box (3" x 0.128") nails 3-(3" x 0.131") nails	Toenail
	<u>Blocking between rafters or truss not at the wall top plate, to rafter or truss</u>	<u>2-8d common (2½" x 0.131") nails</u> <u>2-(3" x 0.131") nails</u>	<u>Each end, toenail</u>
		<u>2-16d common (3½" x 0.162") nails</u> <u>3-(3" x 0.131") nails</u>	<u>End nail</u>
	<u>Flat blocking to truss and web filler</u>	<u>16d common (3½" x 0.162") nails</u> <u>3-(3" x 0.131") nails</u>	<u>6" o.c. face nail</u>
Wall			
12	<u>Adjacent full-height stud to end of header</u>	<u>3-16d common (3½" x 0.162") nails</u> <u>4-16d box (3 ½" x 0.135") nails</u> <u>4-10d box (3" x 0.128") nails</u> <u>4-(3" x 0.131") nails</u>	<u>End nail</u>

Table R602.3(1) Fasteners – Roof Sheathing

Change Type: Modification

- Additional fastener options are added to the fastener table in the roof sheathing section while maximum field nailing is reduced.

Item	Thickness	Number and Type of Fastener	Spacing of Fasteners	
			Edges (inches)	Interm. supports (inches)
Wood structural panels (WSP), subfloor, roof and interior wall sheathing to framing and particleboard wall sheathing to framing				
30-31	$\frac{3}{8}'' - \frac{1}{2}''$	6d common or deformed ($2'' \times 0.113'' \times 0.266''$ head) (subfloor, wall) [†] ; 8d common ($2\frac{1}{2}'' \times 0.131''$) nail (subfloor, wall); Ø 2 $\frac{3}{8}'' \times 0.113'' \times 0.266''$ head nail (subfloor, wall)	6 ^f	12-6 ^f
		8d common ($2\frac{1}{2}'' \times 0.131''$) (roof) RSRS-01 ($2\frac{3}{8}'' \times 0.113''$) nail (roof)	6 ^f	12-6 ^f
31-32	$\frac{19}{32}'' - 1'' \frac{3}{4}''$	8d common ($2\frac{1}{2}'' \times 0.131''$) (subfloor, wall) Deformed $2\frac{3}{8}'' \times 0.113'' \times 0.266''$ head (wall or subfloor)	<u>6</u>	<u>12</u>
		8d common ($2\frac{1}{2}'' \times 0.131''$) nail (roof) RSRS-01 ($2\frac{3}{8}'' \times 0.113''$) nail (roof)	<u>6</u> ^f	12-6 ^f
32-33	$\frac{1\frac{1}{8}'' - \frac{7}{8}''$ $- 1\frac{1}{4}''$	10d common ($3'' \times 0.148''$) nail 8d ($2\frac{1}{2}'' \times 0.131'' \times 0.281''$ head) deformed nail	6	12
<p>f. For wood structural panel roof sheathing attached to gable end roof framing and to intermediate supports within 48 inches of roof edges and ridges, nails shall be spaced at 6 <u>4</u> inches on center where the ultimate design wind speed is greater than 130 mph in Exposure B or greater than 110 mph in Exposure C.</p>				

Table R602.3(2) Alternate Attachments

Change Type: Clarification

- Table R602.3(2) footnote g is updated for clarity

Nominal Material Thickness (inches)	Description of Fastener and Length (inches)	Spacing of Fasteners	
		Edges (inches)	Interm. supports (inches)
Wood structural panels, subfloor, roof ^g and wall sheathing to framing and particleboard wall sheathing to framing			

- g. Alternate fastening is only permitted for roof sheathing where the ultimate design wind speed is less than or equal to 110 mph, and where fasteners are installed 3 inches on center at all supports.

R602.9 Cripple Walls

Change Type: Modification

- Cripple wall requirements apply **only** to exterior cripple walls.

R602.9 Cripple walls. Foundation cripple walls shall be framed of studs not smaller than the studding above. Where exceeding 4 feet (1219 mm) in height, such walls shall be framed of studs having the size required for an additional story. ~~Cripple~~ **Exterior** cripple walls with a stud height less than 14 inches (356 mm) shall be continuously sheathed on one side with wood structural panels fastened to both the top and bottom plates in accordance with Table R602.3(1), or the cripple walls shall be constructed of solid blocking. Cripple walls shall be supported on continuous foundations.

R602.10.1.2 Location of Braced Wall Lines

Change Type: Modification

- Modifications to this section limit placement of a braced wall line (building plans)

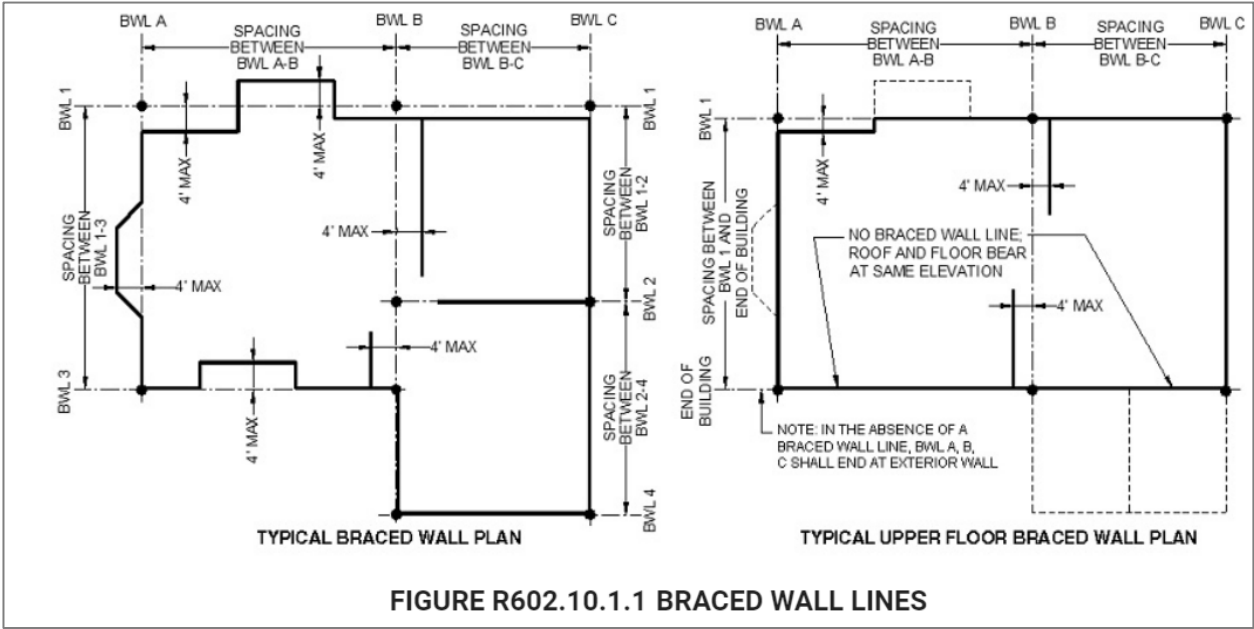

Example 1

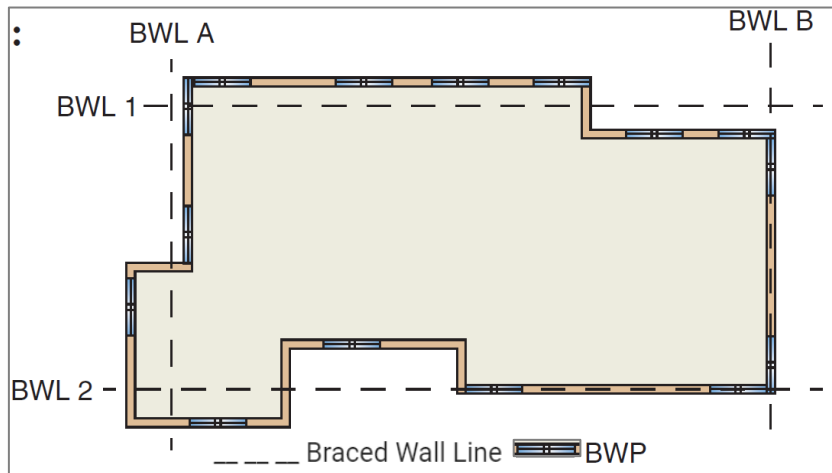

- BWL 1:** line runs between two walls, 4 of 6 panels on outside side of line, 2 of 6 panels on opposite side of line = **OK**
- BWL 2:** line runs between three walls, 1 of 4 panels outside line, 2 of 4 panels on BWL and 1 of 4 panels inside line = **OK**
- BWL A:** line runs between two walls, 2 of 3 panels on one side of line, 1 of 3 panels on opposite side of line = **OK**
- BWL B:** line runs on one wall = **OK**

Example 2

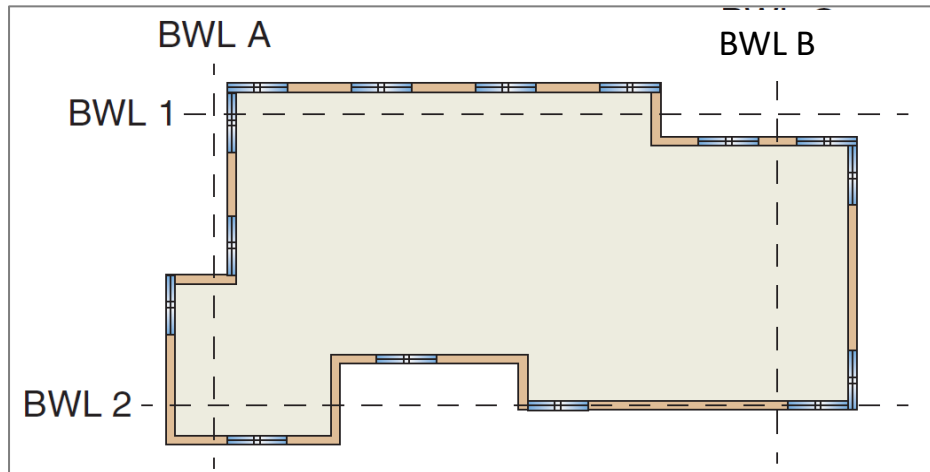

- BWL 1:** line runs between two walls, 4 of 6 panels on outside side of line, 2 of 6 panels on opposite side of line = **OK**
- BWL 2:** line runs between three walls, 1 of 4 panels outside line, 2 of 4 panels on BWL and 1 of 4 panels inside line = **OK**
- BWL A:** line runs between two walls, 2 of 3 panels on one side of line, 1 of 3 panels on opposite side of line = **OK**
- BWL B:** line runs inside single wall, 2 of 2 panels outside BWL = **No Good**

Example 3

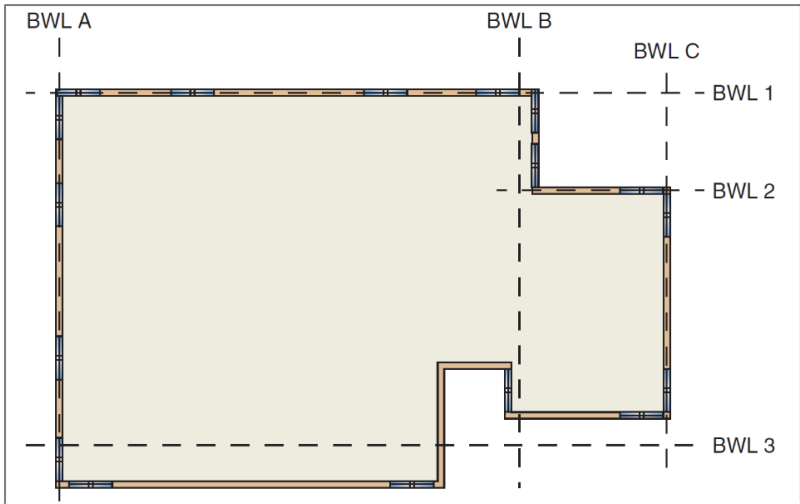

- BWL 1:** line runs along a single wall, 4 of 4 panels are on the BWL = **OK**
- BWL 2:** line runs along a single wall, 1 of 1 panel is on the BWL = **OK**
- BWL 3:** line runs between two walls, 2 of 3 panels on one side of line, 1 of 3 panels on opposite side of line = **OK**
- BWL A:** line runs along a single wall, 4 of 4 panels are on the BWL = **OK**
- BWL B:** line runs between two walls, 2 of 3 panels on one side of line, 1 of 3 panels on opposite side of line = **OK**
- BWL C:** line runs along a single wall, 2 of 2 panels are on the BWL = **OK**

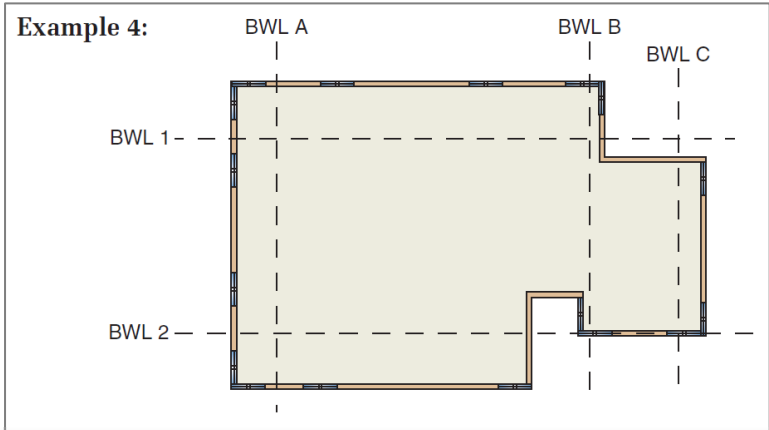

- BWL 1:** line runs between two walls, 4 of 5 panels on one side of line, 1 of 5 panels on opposite side of line = **No Good**, as more than $\frac{2}{3}$ of panels are on one side of the BWL.
- BWL 2:** line runs on one wall, 3 of 5 panels on one side of line, 2 of 5 panels on the wall = **No Good**
- BWL A:** line inside of a single wall, 4 of 4 panels are on one side of the BWL = **No Good**
- BWL B:** line runs between two walls, 1 of 2 panels on one side of line, 1 of 2 panels on opposite side of line = **OK**
- BWL C:** line inside of a single wall, 2 of 2 panels are on the inside of the BWL = **No Good**

R602.10.2.2 Location of Braced Wall Panels

Change Type: Clarification

- Section R602.10.2.2 is clarified for the starting point of the first braced wall panel when not placed at the corner of the structure.

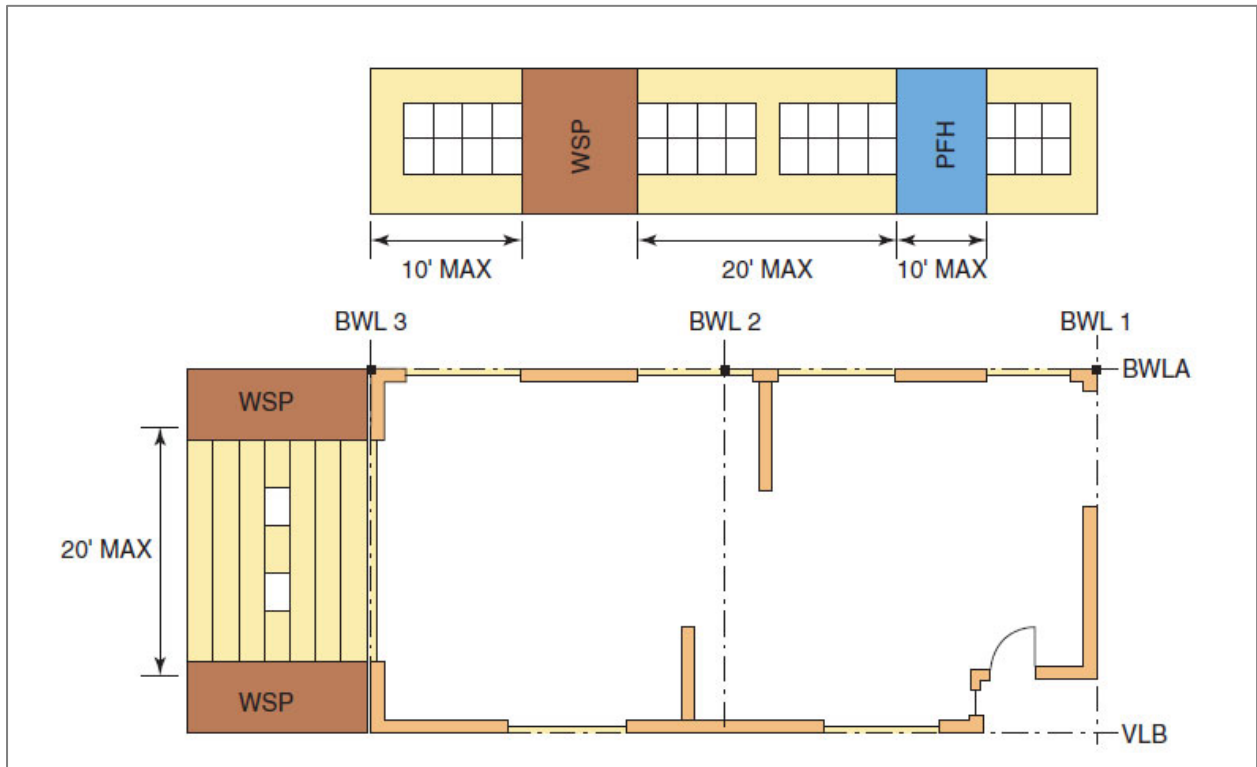

R702.7 Vapor Retarders

Change Type: Modification

- The vapor retarder section is reorganized for clarity and ease of use.
- Materials are listed as Class I, II or III.
- Tables offer appropriate climate zones for each class.
- Class II and III vapor retarders may be used with continuous insulation.

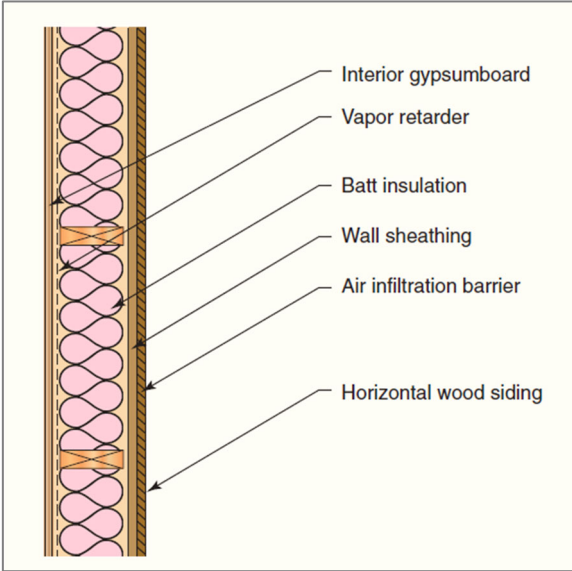

Vapor Retarders

Class I

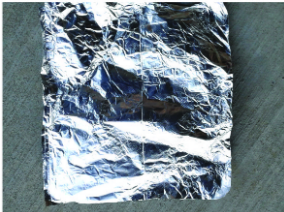

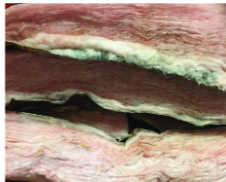

VR < 0.1 perm
Impermeable
Foil and Polyethylene sheets

Class II

0.1 perm < VR < 1 perm
Semi-impermeable
Extruded polystyrene and Kraft fiberglass batts

Class III





1 perm < VR
Semi-impermeable
Latex paint, 30# felt and Plywood

Table R703.8.4(1) Tie Attachment and Airspace

Change Type: Modification

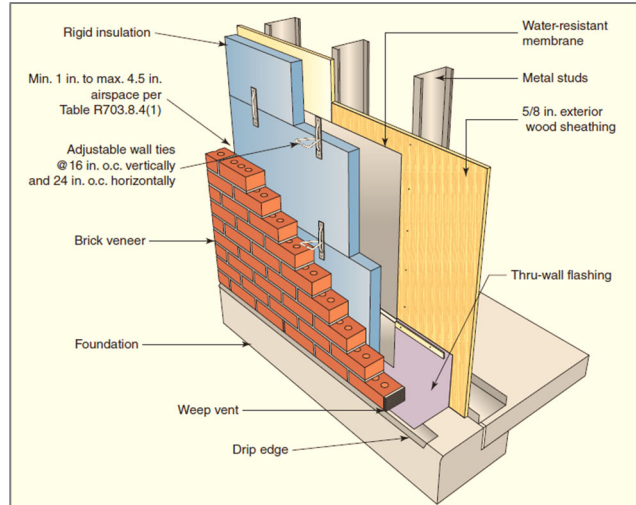
- Larger air gaps are allowed behind veneer to accommodate thicker continuous insulation. (Note: table not showing the min. Tie and Tie fastener columns)



Backing and Tie	Airspace ^b	
Wood stud backing with corrugated sheet metal	Nominal 1 in. between sheathing and veneer	
Wood stud backing with <u>adjustable</u> metal strand wire	Minimum nominal 1 in. between sheathing and veneer	Maximum 4 $\frac{5}{8}$ in. between backing and veneer
<u>Wood stud backing with adjustable metal strand wire</u>	<u>Greater than 4$\frac{5}{8}$ in. between backing and veneer</u>	<u>Maximum 6$\frac{5}{8}$ in. between backing and veneer</u>
Cold-formed steel stud backing with adjustable metal strand wire	Minimum nominal 1 in. between sheathing and veneer	Maximum 4 $\frac{5}{8}$ in. between backing and veneer
<u>Cold-formed steel stud backing with adjustable metal strand wire</u>	<u>Greater than 4$\frac{5}{8}$ in. between backing and veneer</u>	<u>Maximum 6$\frac{5}{8}$ in. between backing and veneer</u>

NEW FOOTNOTES d-f:

- d. Adjustable tie pintles shall include a minimum of 1 pintle leg of wire size W2.8 with a maximum offset of 1-1/4 in.
- e. Adjustable tie pintles shall include a minimum of 2 pintle legs with a maximum offset of 1 1/4 in. Distance between inside face of brick and end of pintle shall be a maximum of 2 in.
- f. Adjustable tie backing attachment components shall consist of one of the following: eyes with minimum wire W2.8, barrel with minimum 1/4 in. outside dia., or plate with minimum thickness of 0.074 in. and minimum width of 1 1/4 in.

R704 Soffits

Change Type: Addition

- Requirements for soffit material and installation are expanded in a new section.

R704 Soffits – New section overview

R704.1 General wind limitations

R704.2 Soffit installation where the design wind pressure is 30 psf or less

R704.2.1 Vinyl soffit panels

R704.2.2 Fiber-cement soffit panels

R704.2.3 Hardboard soffit panels

R704.2.4 Wood structural panel soffit

R704.3 Soffit installation where the design wind pressure exceeds 30 psf

R704.3.1 Vinyl soffit panels

R704.3.2 Fiber-cement soffit panels

R704.3.3 Hardboard soffit panels

R704.3.4 Wood structural panel soffit

TABLE R704.3.4 Prescriptive Alt. for Wood Structural Panel Soffit

Figures R704.2.1(1) and R704.2.1 (2)

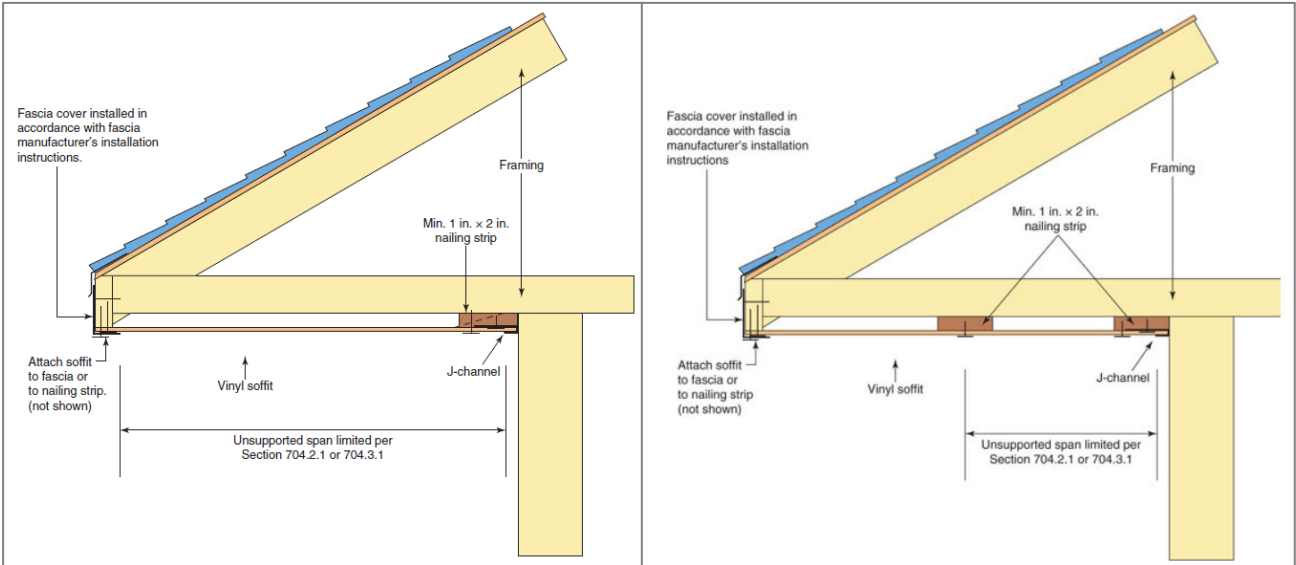

TABLE R704.3.4 Prescriptive Alternative for Wood Structural Panel Soffit

- New prescriptive alternative table provides fastening requirements for areas where the **design wind pressure exceeds 30 psf**.

Maximum Design Pressure (+ or - psf)	Minimum Panel Span Rating	Minimum Panel Performance Category	Nail Type and Size	Fastener^a Spacing Along Edges and Intermediate Supports	
				Galvanized Steel	Stainless Steel
30	<u>24/0</u>	<u>3/8</u>	6d box (2 x 0.099 x 0.266 head diameter)	<u>6^f</u>	<u>4</u>
40	<u>24/0</u>	<u>3/8</u>	6d box (2 x 0.099 x 0.266 head diameter)	<u>6</u>	<u>4</u>
50	<u>24/0</u>	<u>3/8</u>	6d box (2 x 0.099 x 0.266 head diameter)	<u>4</u>	<u>4</u>
			8d common (2½ x 0.131 x 0.281 head diameter)	<u>6</u>	<u>6</u>
60	<u>24/0</u>	<u>3/8</u>	6d box (2 x 0.099 x 0.266 head diameter)	<u>4</u>	<u>3</u>
			8d common (2½ x 0.131 x 0.281 head diameter)	<u>6</u>	<u>4</u>
70	<u>24/16</u>	<u>7/16</u>	8d common (2½ x 0.131 x 0.281 head diameter)	<u>4</u>	<u>4</u>
			10d box (3 x 0.128 x 0.312 head diameter)	<u>6</u>	<u>4</u>
80	<u>24/16</u>	<u>7/16</u>	8d common (2½ x 0.131 x 0.281 head diameter)	<u>4</u>	<u>4</u>
			10d box (3 x 0.128 x 0.312 head diameter)	<u>6</u>	<u>4</u>
90	<u>32/16</u>	<u>15/32</u>	8d common (2½ x 0.131 x 0.281 head diameter)	<u>4</u>	<u>3</u>
			10d box (3 x 0.128 x 0.312 head diameter)	<u>6</u>	<u>4</u>
See full code section for footnotes					

Table R802.5.2(1) Heel Joint Connections

Change Type: Modification

- The heel joint connection table is updated for roof spans of 24 and 36 feet and a 19.2-inch rafter spacing. New footnote a is added.

RAFTER SLOPE	RAFTER SPACING (inches)	GROUND SNOW LOAD (psf)											
		20 ^e			30			50			70		
		Roof span (feet)											
		12	24	36	12	24	36	12	24	36	12	24	36
Required number of 16d common nails per heel joint splice ^{a,b,c,d,f}													
3:12	12	<u>3</u>	<u>5</u>	<u>8</u>	<u>3</u>	<u>6</u>	<u>9</u>	5	<u>9</u>	<u>13</u>	6	<u>12</u>	<u>17</u>
	16	4	<u>7</u>	<u>10</u>	4	<u>8</u>	<u>12</u>	6	<u>12</u>	<u>17</u>	8	<u>15</u>	<u>23</u>
	<u>19.2</u>	4	<u>8</u>	<u>12</u>	5	<u>10</u>	<u>14</u>	7	<u>14</u>	<u>21</u>	9	<u>18</u>	<u>27</u>
	24	<u>5</u>	<u>10</u>	<u>15</u>	<u>6</u>	<u>12</u>	<u>18</u>	9	<u>17</u>	<u>26</u>	12	<u>23</u>	<u>34</u>
4:12	12	3	<u>4</u>	<u>6</u>	3	<u>5</u>	<u>7</u>	4	<u>7</u>	<u>10</u>	5	<u>9</u>	<u>13</u>
	16	<u>3</u>	<u>5</u>	<u>8</u>	<u>3</u>	<u>6</u>	<u>9</u>	5	<u>9</u>	<u>13</u>	6	<u>12</u>	<u>17</u>
	<u>19.2</u>	<u>3</u>	<u>6</u>	<u>9</u>	4	<u>7</u>	<u>11</u>	<u>6</u>	<u>11</u>	<u>16</u>	7	<u>14</u>	<u>21</u>
	24	<u>4</u>	<u>8</u>	<u>11</u>	<u>5</u>	<u>9</u>	<u>13</u>	7	<u>13</u>	<u>19</u>	9	<u>17</u>	<u>26</u>
5:12	12	3	<u>3</u>	<u>5</u>	3	<u>4</u>	<u>6</u>	3	<u>6</u>	<u>8</u>	4	<u>7</u>	<u>11</u>
	16	3	<u>4</u>	<u>6</u>	3	<u>5</u>	<u>7</u>	4	<u>7</u>	<u>11</u>	5	<u>9</u>	<u>14</u>
	<u>19.2</u>	<u>3</u>	<u>5</u>	<u>7</u>	<u>3</u>	<u>6</u>	<u>9</u>	<u>5</u>	<u>9</u>	<u>13</u>	<u>6</u>	<u>11</u>	<u>17</u>
	24	<u>3</u>	<u>6</u>	<u>9</u>	4	<u>7</u>	<u>11</u>	6	<u>11</u>	<u>16</u>	7	<u>14</u>	<u>21</u>
Sections for 7:12 and 9:12 Slopes not shown – see full code section													
12:12	12	3	<u>3</u>	3	3	<u>3</u>	3	3	<u>3</u>	4	3	<u>3</u>	5
	16	3	<u>3</u>	<u>3</u>	3	<u>3</u>	<u>3</u>	3	<u>3</u>	5	3	<u>4</u>	<u>6</u>
	<u>19.2</u>	<u>3</u>	<u>3</u>	<u>3</u>	<u>3</u>	<u>3</u>	<u>4</u>	<u>3</u>	<u>4</u>	<u>6</u>	<u>3</u>	<u>5</u>	<u>7</u>
	24	3	<u>3</u>	<u>4</u>	3	<u>3</u>	<u>5</u>	3	<u>5</u>	<u>7</u>	3	<u>6</u>	<u>9</u>
<p>a. <u>10d common (3" x 0.148") nails shall be permitted to be substituted for 16d common (3½"x 0.162") nails where the required number of nails is taken as 1.2 times the required number of 16d common nails, rounded up to the next full nail.</u></p> <p>See code section table for all footnotes</p>													

N1101.6 Definition of High-Efficacy Light Sources

Change Type: Modification

- The definition related to high-efficacy lighting now includes both lamps and luminaires and better reflects current technology and federal standards.



HIGH-EFFICACY LAMPS LIGHT SOURCES. Any lamp with an efficacy of not less than 65 lumens per watt, or luminaires with an efficacy of not less than 45 lumens per watt.

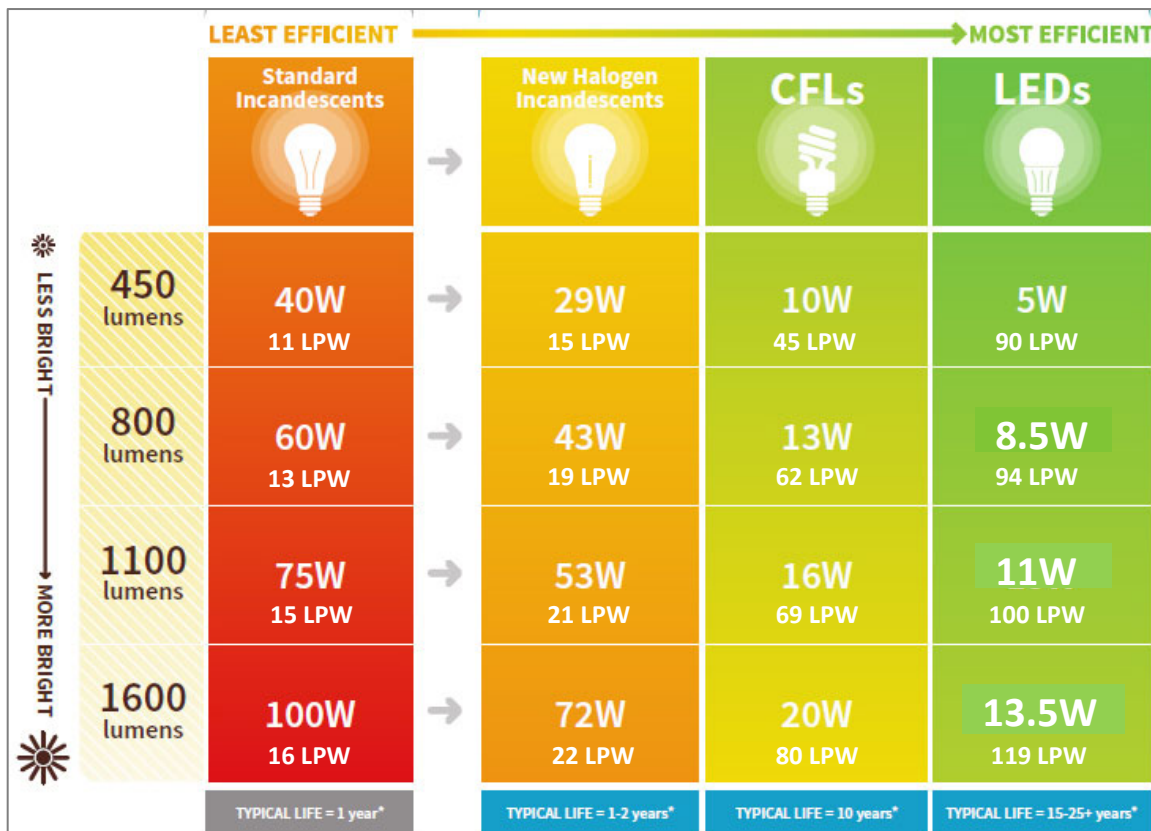

- TYPICAL Wattages, LED wattages as of 9/2023 – See bulb manufacturer documentation for specific bulb ratings
- LPW = Lumens Per Watt

N1101.7 Climate Zones

Change Type: Modification

- Climate zones have been comprehensively updated for the 2021 VRC/IRC

- **VA now has 3 zones**
 - Most counties stay zone 4A (mixed humid)
 - **19 Counties move to 3A (warm humid)**
 - **5 counties move to 5A (cool humid)**

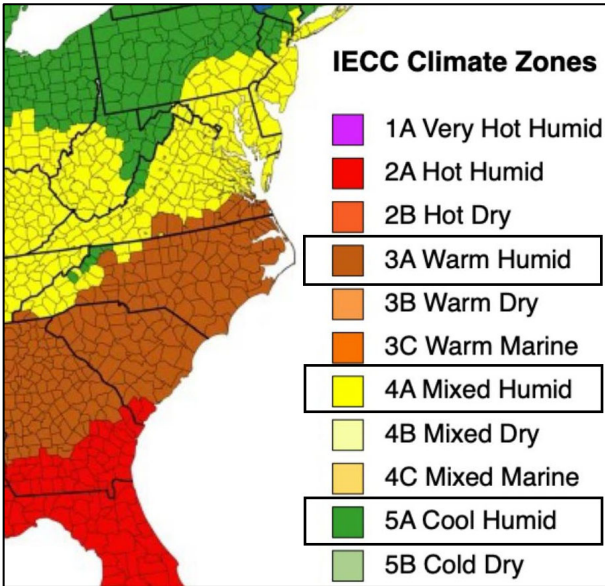

3A VA Counties/Cities/Towns:

Brunswick
Chesapeake
Emporia
Franklin
Greensville
Halifax
Hampton
Isle of Wight
Mecklenburg
Newport News
Norfolk
Pittsylvania
Portsmouth
South Boston
Southampton
Suffolk
Surry
Sussex
Virginia Beach

5A VA Counties/Cities/Towns:

Alleghany
Bath
Clifton Forge
Covington
Highland

N1101.13 Compliance Options

Change Type: Modification

- The compliance path options (Prescriptive, Total Building Performance, Energy Rating Index and Tropical Zone) have been clarified and the Prescriptive and Mandatory labels in the section titles have been removed.

N1101.13 (R401.2) Compliance Application. ~~Projects Residential buildings~~ shall comply with Section N1101.13.5 and Section N1101.13.1, N1101.13.2, N1101.13.3, OR N1101.13.4. ~~one of the following:~~

- ~~1. Sections N1101.14 through N1104.~~
- ~~2. Section N1105 and the provisions of Sections N1101.14 through N1104 indicated as “Mandatory.”~~
- ~~3. The energy rating index (ERI) approach in Section N1106.~~

Exception: Additions, alterations, repairs and changes of occupancy to existing buildings complying with Sections N1109 through N1113 as applicable.

N1101.13.1 (R401.2.1) Prescriptive Compliance Option. The Prescriptive Compliance Option requires compliance with Sections N1101.14 through N1104.

N1101.13.2 (R401.2.2) Total Building Performance Option. The Total Building Performance Option requires compliance with Section N1105.

N1101.13.3 (R401.2.3) Energy Rating Index Option. The Energy Rating Index (ERI) Option requires compliance with Section N1106.

N1101.13.4 (R401.2.4) Tropical Climate Region Option. The Tropical Climate Region Option requires compliance with Section N1107.

N1101.13.5 Additional Energy Efficiency Requirements

Change Type: Addition

- Prescriptive compliance projects must include one package from Section N1108.
- Total building performance compliance projects must either include one package from N1108 (without including it in the proposed design calculations), or the proposed design must have an annual energy cost less than or equal to 95% of the standard reference design.
- Projects complying via the ERI path do not require any of the additional efficiency package options in Section N1108, but must have a score at least 5% less than that in the ERI Table N1106.4.

N1108 Additional Efficiency Package Options

- **N1108.2.1 Enhanced envelope performance option**
- **N1108.2.2 More efficient HVAC equipment performance option**
- **N1108.2.3 Reduced energy use in service water-heating option**
- **N1108.2.4 More efficient duct thermal distribution system option**
- **N1108.2.5 Improved air sealing and efficient ventilation system option**

N1101.14 Permanent Energy Certificate

Change Type: Modification

- **Additional information required:**
 - Addition details for fenestration U-factors
 - Sizes of heating, cooling, and service water heating equipment
 - PV (Solar) system details – if applicable
 - Energy Rating Index (ERI) score – if applicable
 - Code edition and compliance path used

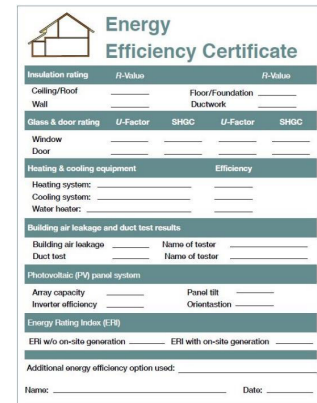

The image shows a sample Energy Efficiency Certificate form. It includes sections for Insulation rating (Ceiling/Roof, Floor/Foundation, Wall, Ductwork), Glass & door rating (U-Factor, SHGC), Heating & cooling equipment (Heating system, Cooling system, Water heater), Building air leakage and duct test results (Building air leakage, Duct test), Photovoltaic (PV) panel system (Array capacity, Inverter efficiency, Panel tilt, Orientation), and Energy Rating Index (ERI) score (ERI with on-site generation, ERI with on-site generation). There is also a section for Additional energy efficiency option used, Name, and Date.

N1101.14 (R401.3) Certificate. A permanent certificate shall be completed by the builder or other approved party and posted on a wall in the space where the furnace is located, a utility room or an approved location inside the building. Where located on an electrical panel, the certificate shall not cover or obstruct the visibility of the circuit directory label, service disconnect label or other required labels. The certificate shall indicate the following:

1. The predominant R-values of insulation installed in or on ceilings, roofs, walls, foundation components such as slabs, basement walls, crawl space walls and floors, and ducts outside conditioned spaces.
2. The U-factors of fenestration and the solar heat gain coefficient (SHGC) of fenestration. Where there is more than one value for any component of the building envelope, the certificate shall indicate both the value covering the largest area and the area weighted average value if available.
3. The results from any required duct system and building envelope air leakage testing performed on the building.
4. The types, sizes and efficiencies of heating, cooling and service water heating equipment. Where a gas-fired unvented room heater, electric furnace, or baseboard electric heater is installed in the residence, the certificate shall indicate “gas-fired unvented room heater,” “electric furnace” or “baseboard electric heater,” as appropriate. An efficiency is not required to be indicated for gas-fired unvented room heaters, electric furnaces and electric baseboard heaters.
5. **Where onsite photovoltaic panel systems have been installed, the array capacity size, inverter efficiency, panel tilt and orientation shall be noted on the certificate.**
6. **For buildings where an Energy Rating Index score is determined in accordance with Section N1106, the Energy Rating Index score, both with and without any on-site generation, shall be listed on the certificate.**
7. **The code edition under which the structure was permitted and the compliance path used.**

N1102.1 Building Thermal Envelope

Change Type: Modification

- The assembly *U*-Factor is established as the primary insulation metric.
- The *R*-Value approach is now an alternative method.

N1102.1 (R402.1) General (Prescriptive). The building thermal envelope shall comply with the requirements of Sections N1102.1.1 through N1102.1.5.

Exceptions: [No changes]

N1102.1.1 (R402.1.1) Vapor retarder. Wall assemblies in the building thermal envelope shall comply with the vapor retarder requirements of Section R702.7.

N1102.1.2 (R402.1.2) Insulation and fenestration criteria. The building thermal envelope shall meet the requirements of Table N1102.1.2 based on the climate zone specified in Section N1101.7. Assemblies shall have a U-factor equal to or less than that specified in Table N1102.1.2. Fenestration shall have a U-factor and glazed fenestration SHGC equal to or less than specified in Table N1102.1.2.

N1102.1.3(R402.1.3) R-value alternative. Assemblies with R-value of insulation materials equal to or greater than that specified in Table N1102.1.3 shall be an alternative to the U-factor in Table N1102.1.2.

~~N1102.1.3 (R402.1.3)~~ **N1102.1.4 (R402.1.4) R-value computation.** Insulation material used in layers, such as framing cavity insulation or continuous insulation, Cavity insulation alone shall be used to determine compliance with the cavity insulation R-value requirements in Table N1102.1.3. Where cavity insulation is installed in multiple layers, the R-values of the cavity insulation layers shall be summed to compute the corresponding component R-value determine compliance with the cavity insulation R-value requirements. The manufacturer's settled R-value shall be used for blown-in insulation. Continuous insulation (ci) alone shall be used to determine compliance with the continuous insulation R-value requirements in Table N1102.1.3. Where continuous insulation is installed in multiple layers, the R-values of the continuous insulation layers shall be summed to determine compliance with the continuous insulation R-value requirements. Cavity insulation R-values shall not be used to determine compliance with the continuous insulation R-value requirements in Table N1102.1.3. Computed R-values shall not include an R-value for other building materials or air films. Where insulated siding is used for the purpose of complying with the continuous insulation requirements of Table N1102.1.2 N1102.1.3, the manufacturer's labeled R-value for insulated siding shall be reduced by R-0.6.

Tables N1102.1.2 and N1102.1.3 Insulation and Fenestration Requirements

Change Type: Modification

- *U*-factors are lowered, and *R*-values are increased in the prescriptive tables.
- The table order is reversed to recognize that the assembly *U*-Factors are the primary method for determining compliance.
- Other changes relate to footnotes, additional options for using continuous insulation (ci), and clarification to the tables.

TABLE N1102.1.4 (R402.1.4) N1102.1.2 (R402.1.2) Equivalent Maximum Assembly <i>U</i> -Factors ^a and Fenestration Requirements									
Climate Zone	Fenestration <i>U</i> -Factor ^f	Skylight <i>U</i> -Factor	Glazed Fenestration SHGC ^{d, e}	Ceiling <i>U</i> -Factor	Frame Wall <i>U</i> -Factor	Mass Wall <i>U</i> -Factor ^b	Floor <i>U</i> -Factor	Basement Wall <i>U</i> -Factor	Crawl Space Wall <i>U</i> -Factor
3	0.32 <u>.30</u>	0.55	<u>0.25</u>	0.030 <u>0.026</u>	0.060 0.079	0.098	0.047	0.091 ^c	0.136
4 except Marine	0.32 <u>.30</u>	0.55	<u>0.40</u>	0.026 <u>0.024</u>	0.060 0.045 0.079	0.098	0.047	0.059	0.065
5 and Marine 4	0.30	0.55	<u>0.40</u>	0.026 <u>0.024</u>	0.060 0.045 0.079	0.082	0.033	0.050	0.055

**TABLE N1102.1.2 (R402.1.2) TABLE N1102.1.3 (R402.1.3) Insulation
Minimum R-Values and Fenestration Requirements by Component^a**

Climate Zone	Fenestration U -Factor ^{b,i}	Skylight ^b U -Factor	Glazed Fenestration SHGC ^{b,e}	Ceiling R -Value	Wood Frame Wall R -value ^g	Mass Wall R -value ^h	Floor R -Value	Basement ^{c,d} Wall R -Value	Slab ^e R -value & Depth	Crawl Space ^{c,d} Wall R -value
3	0.32 0.30	.55	0.25	38 49	20 or 13 + 5ci or 0 + 15ci 15 or 13 + 1	8/13	19	5ci or 13 ^g	10ci, 2 ft	5ci /or 13
4 except Marine	0.32 0.30	.55	0.40	49 60	20 or 13 + 5ci or 0 + 15ci 15 or 13 + 1	8/13	19	10ci or 13	10ci, 2 4 ft	10 ci or 1 3
5 and Marine 4	0.30	.55	0.40	49 60	20 or 13 + 5ci or 0 + 15ci 15 or 13 + 1	13/17	30 ^g	15ci or 19 or 13+5ci	10ci, 2 4 ft	15ci /or 1 9 or 13+5ci

Footnote g. The first value is cavity insulation, the second value is continuous insulation. Therefore, as an example, "13+5" means R-13 cavity insulation plus R-5 continuous insulation.

N1102.2 Ceiling Insulation

Change Type: Modification

- The options for a reduction in *R*-values for both ceilings with attics and those without have been adjusted to recognize the increase in the prescriptive ceiling *R*-values in Table N1102.1.3.

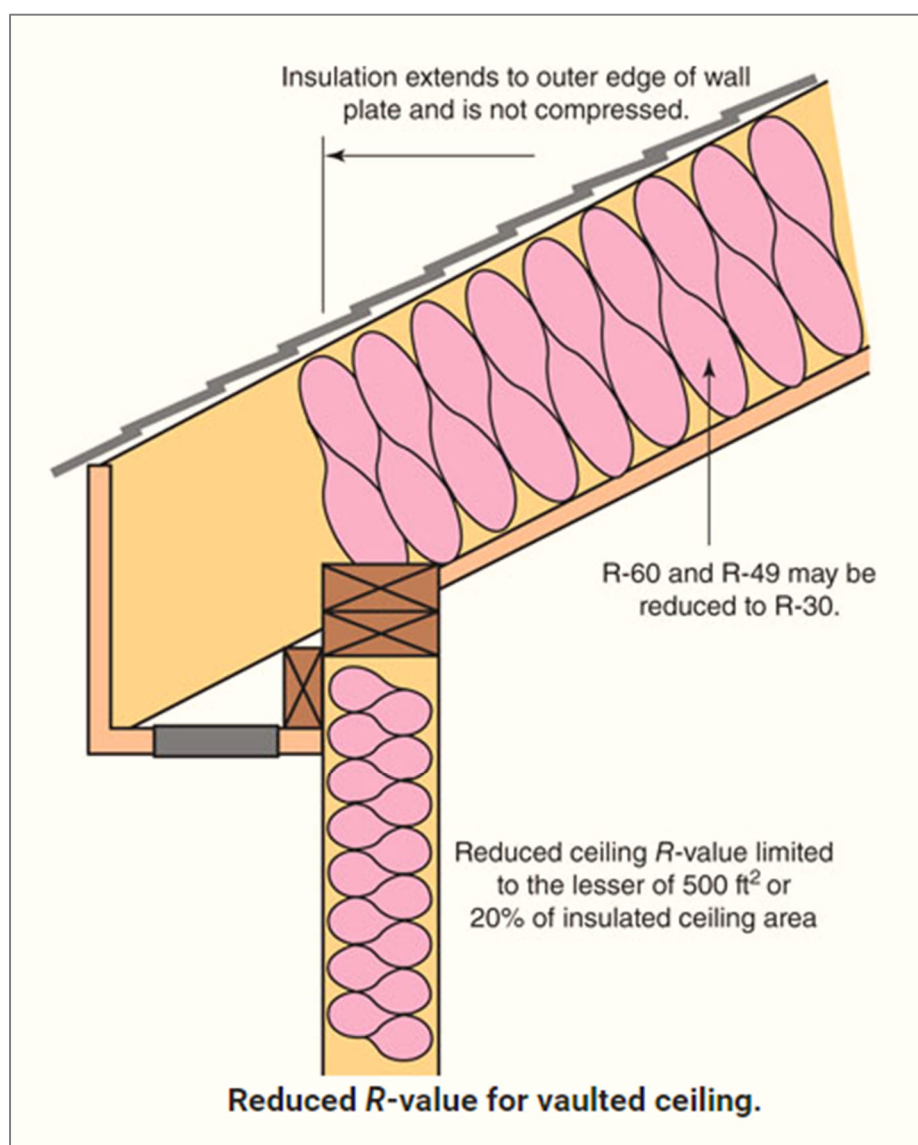

~~N1102.2.7 R-Value Reduction for Walls with Partial Structural Sheathing~~

Change Type: Deletion

- The provision for reducing the R-value of the required continuous wall insulation at areas of structural wall sheathing has been deleted.

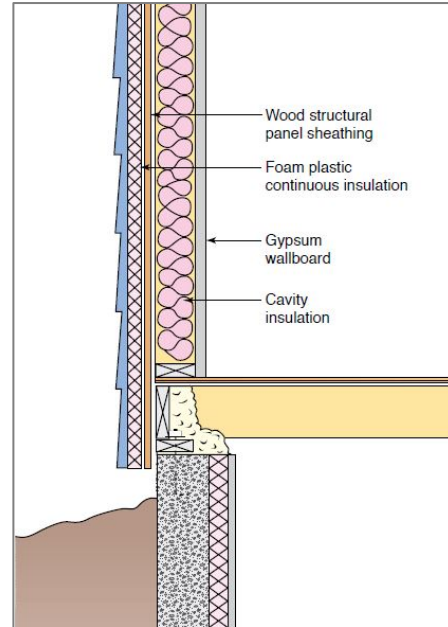

~~N1102.2.7 (R402.2.7) Walls with partial structural sheathing.~~ Where Section N1102.1.2 requires continuous insulation on exterior walls and structural sheathing covers 40 percent or less of the gross area of all exterior walls, the required continuous insulation R-value shall be permitted to be reduced by an amount necessary, but not more than R-3, to result in a consistent total sheathing thickness on areas of the walls covered by structural sheathing. This reduction shall not apply to the U-factor alternative in Section N1102.1.4 and the Total UA alternative in Section N1102.1.5.

N1102.2.7 Floor Insulation

Change Type: Clarification

- Three separate methods of compliance:
 - Cavity insulation underside of subfloor
 - Cavity insulation top side of ceiling
 - Cavity and continuous insulation top side of ceiling

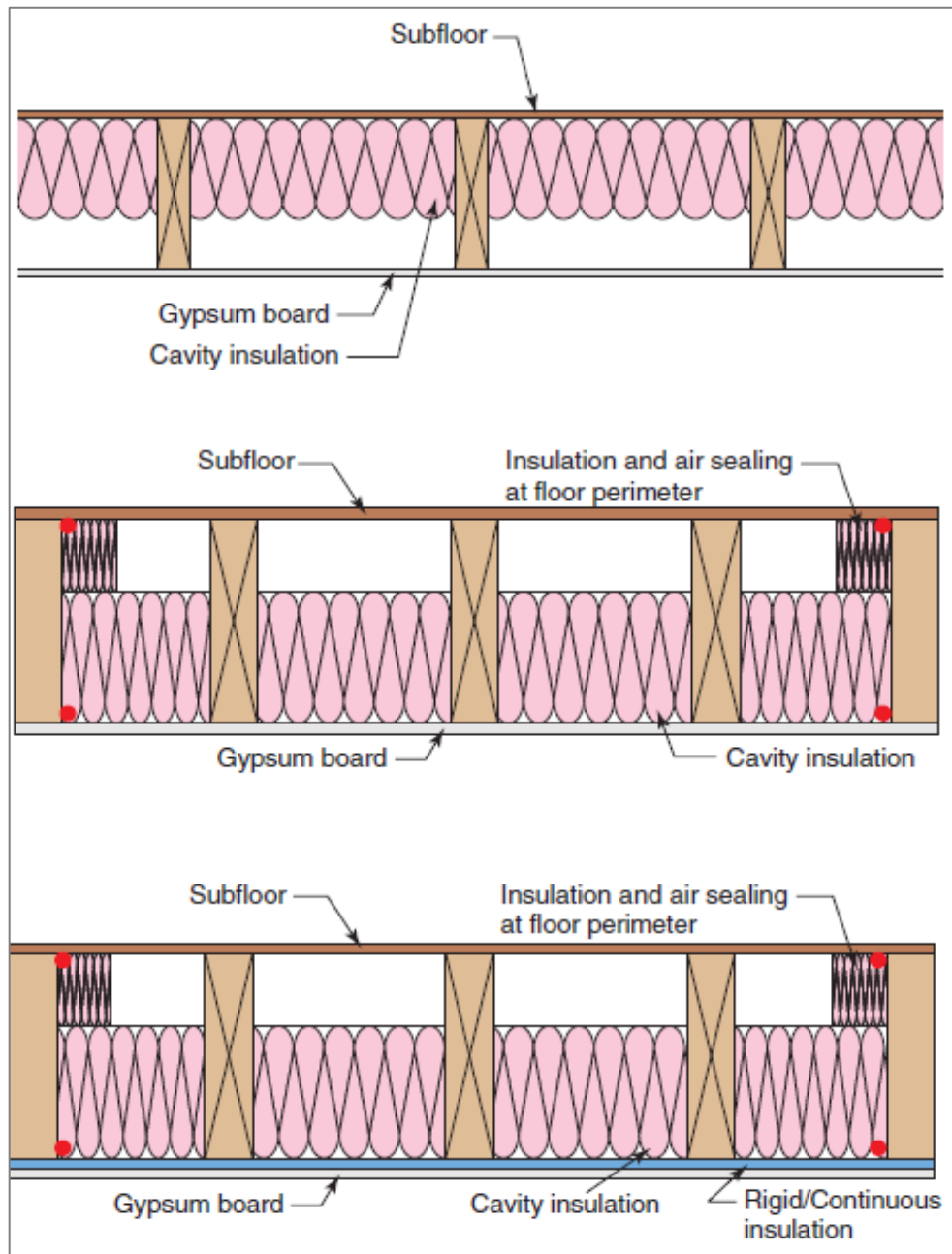

N1102.2.8 Unconditioned Basement

Change Type: Modification

- This Modification comprehensively clarifies what qualifies as an unconditioned basement.

N1102.2.8 (R402.2.8) Basement Walls. Basement walls shall be insulated in accordance with Table N1102.1.3.

Exception: Basement walls associated with unconditioned basements where all of the following requirements are met:

1. The floor overhead, including the underside stairway stringer leading to the basement, is insulated in accordance with Section N1102.1.3 and applicable provisions of Sections N1102.2 and N1102.2.7.
2. There are no uninsulated duct, domestic hot water, or hydronic heating surfaces exposed to the basement.
3. There are no HVAC supply or return diffusers serving the basement.
4. The walls surrounding the stairway and adjacent to conditioned space are insulated in accordance with Section N1102.1.3 and applicable provisions of Section N1102.2.
5. The door(s) leading to the basement from conditioned spaces are insulated in accordance with Section N1102.1.3 and applicable provisions of Section N1102.2, and weather-stripped in accordance with Section N1102.4.
6. The building thermal envelope separating the basement from adjacent conditioned spaces complies with Section N1102.4.

N1102.2.9 (R402.2.9) N1102.2.8.1 (R402.2.8.1) Basement walls insulation installation. ~~Walls associated with conditioned basements~~ Where basement walls are insulated, the insulation shall be insulated-installed from the top of the basement wall down to 10 feet (3048 mm) below grade or to the basement floor, whichever is less. ~~Walls associated with unconditioned basements shall comply with this requirement except where the floor overhead is insulated in accordance with Sections N1102.1.2 and N1102.2.8.~~

N1102.4.6 Air-Sealed Electrical Boxes

Change Type: Addition

- Electrical and communication outlet boxes installed **in the building thermal envelope** must be:
 - Sealed
 - Tested NEMA OS 4
 - Marked "NEMA OS 4" or "OS 4"
 - Installed per manufacturer's instructions and NEMA OS 4

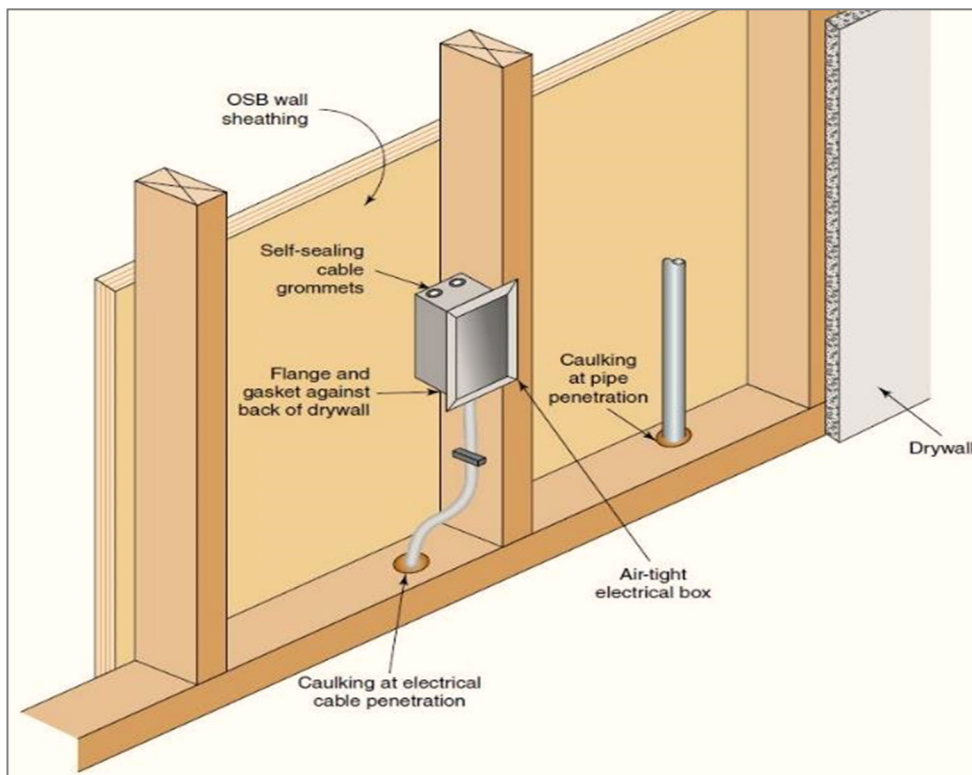

N1102.4.6 (R402.4.6) Electrical and communication outlet boxes (air-sealed boxes).

Electrical and communication outlet boxes installed in the building thermal envelope shall be sealed to limit air leakage between conditioned and unconditioned spaces. Electrical and communication outlet boxes shall be tested in accordance with NEMA OS 4, Requirements for Air-Sealed Boxes for Electrical and Communication Applications, and shall have an air leakage rate of not greater than 2.0 cubic feet per minute (0.944 L/s) at a pressure differential of 1.57 psf (75 Pa). Electrical and communication outlet boxes shall be marked "NEMA OS 4" or "OS 4" in accordance with NEMA OS 4. Electrical and communication outlet boxes shall be installed per the manufacturer's instructions and with any supplied components required to achieve compliance with NEMA OS 4.

N1103.1.3 (VECC R403.1.3) Heat Pump as Primary Space Heat Source

Change Type: VA Addition (proposal REC-R403.1.2-21)

- This new VA Amendment prohibits electric resistance heat (like “baseboard heaters”) from being installed as the primary heat source **IF a ducted or ductless heat pump can be installed.**
- This type of heating may continue to be used for “defrost, supplemental, or emergency heat”.
- Heat pumps must be designed so that supplemental resistance heat does not energize unless the outdoor temperature is below 40°F, except during defrost or emergency heating modes.

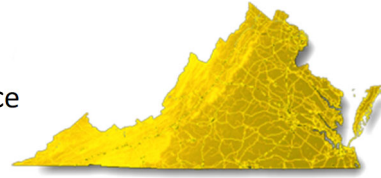

N1103.1.3 (R403.1.3) Heat pump as primary space heat source.

Electric resistance heat shall not be used as the primary heat source for electric space heating if a ducted or ductless heat pump can be installed. Electric resistance space heating may be used for defrost, supplemental, or emergency heat. A heat pump shall be designed so that, except during defrost or emergency heating modes, supplemental heating does not energize unless the outdoor temperature is below 40°F (4°C).

N1103.3 Duct Installation

Change Type: Addition

- Now clearly defines four scenarios where ductwork qualifies as being in conditioned space:
 - Duct system completely within the continuous air barrier and building thermal envelope
 - Duct work in ventilated attic and buried within ceiling insulation
 - Duct work in floor cavities over unconditioned space
 - Duct work within exterior walls

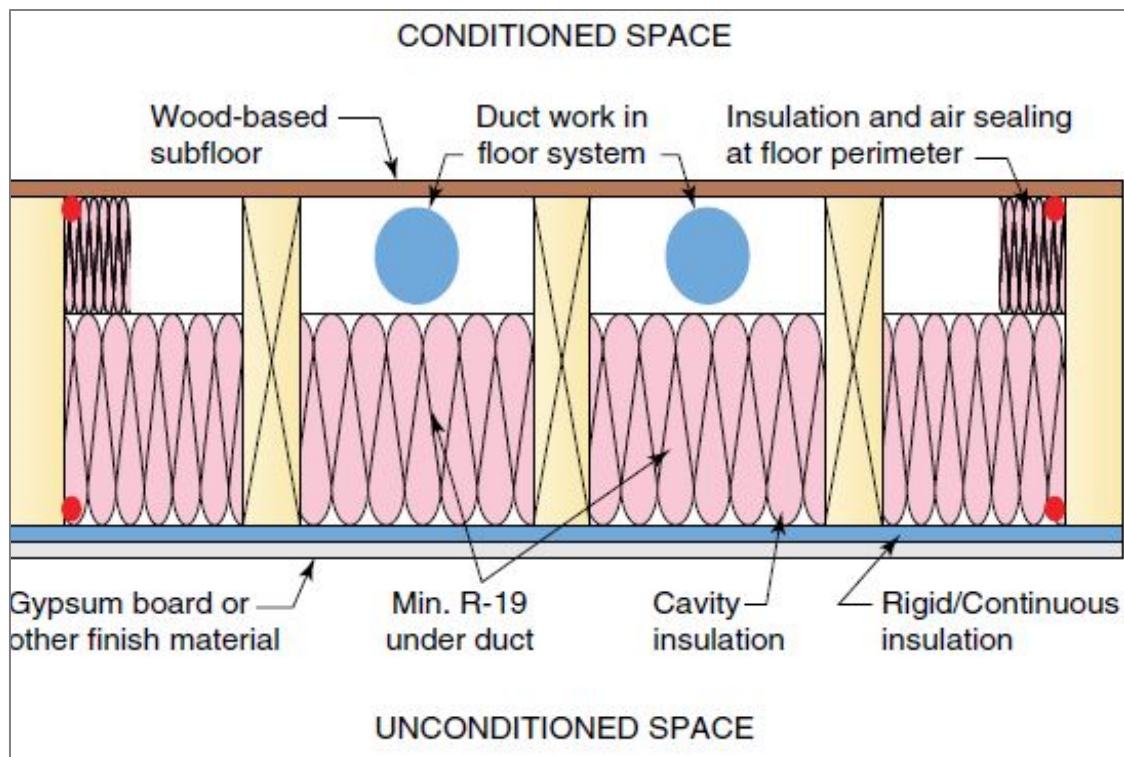

~~N1103.3.3~~ N1103.3.5 Duct Testing

Change Type: Modification

- This section has been updated with current test standards and the exception language has been modified significantly.
- **Ducts and air handlers entirely within the building thermal envelope are no longer exempt from testing**, and the exception now applies only to “ducts serving heating, cooling or ventilation systems **that are not integrated** with ducts serving heating or cooling systems.”

~~N1103.3.3 (R403.3.3)~~ N1103.3.5 (R403.3.5) Duct testing. Ducts shall be pressure tested in accordance with ANSI/RESNET/ICC 380 or ASTM E1554 to determine air leakage by one of the following methods:

1. Rough-in test: *(code text unchanged - not shown)*
2. Postconstruction test: *(code text unchanged - not shown)*

Exception: A duct air-leakage test shall not be required where the ~~ducts and air handlers are located entirely within the building thermal envelope.~~ for ducts serving heating, cooling or ventilation systems that are not integrated with ducts serving heating or cooling systems.

(remaining section text unchanged – not shown)

~~N1103.3.4~~ N1103.3.6 Ducts within Thermal Envelope

Change Type: Addition

- A new item #3 is added to this section, which includes allowable duct leakage rates for scenarios “where all ducts and air handlers are located entirely within the building thermal envelope”

N1103.3.6 (R403.3.6) Duct leakage. The total leakage of the ducts, where measured in accordance with Section N1103.3.5, shall be as follows:

1. Rough-in test: *(unchanged – code text not shown)*
2. Postconstruction test: *(unchanged – code text not shown)*
3. Test for ducts within thermal envelope: Where all ducts and air handlers are located entirely within the building thermal envelope, total leakage shall be less than or equal to 8.0 cubic feet per minute (226.6 L/min) per 100 square feet (9.29 m²) of conditioned floor area.

N1103.3.7 Building Cavities (used as ducts or plenums)

Change Type: VA Addition (proposal REC - R403.3.3 – 21)

- This amendment adds language that specifically addresses framing cavities used as ducts or plenums, requiring they meet the requirements of VRC M1601.1.1 (Above Ground Duct Systems - which includes additional plenum requirements and restrictions – see VRC M1601.1.1 for full details).

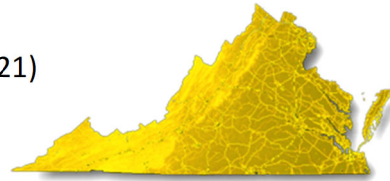

N1103.3.7 (R403.3.7) Building cavities. Building framing cavities used as ducts or plenums shall comply with VRC Section M1601.1.1.

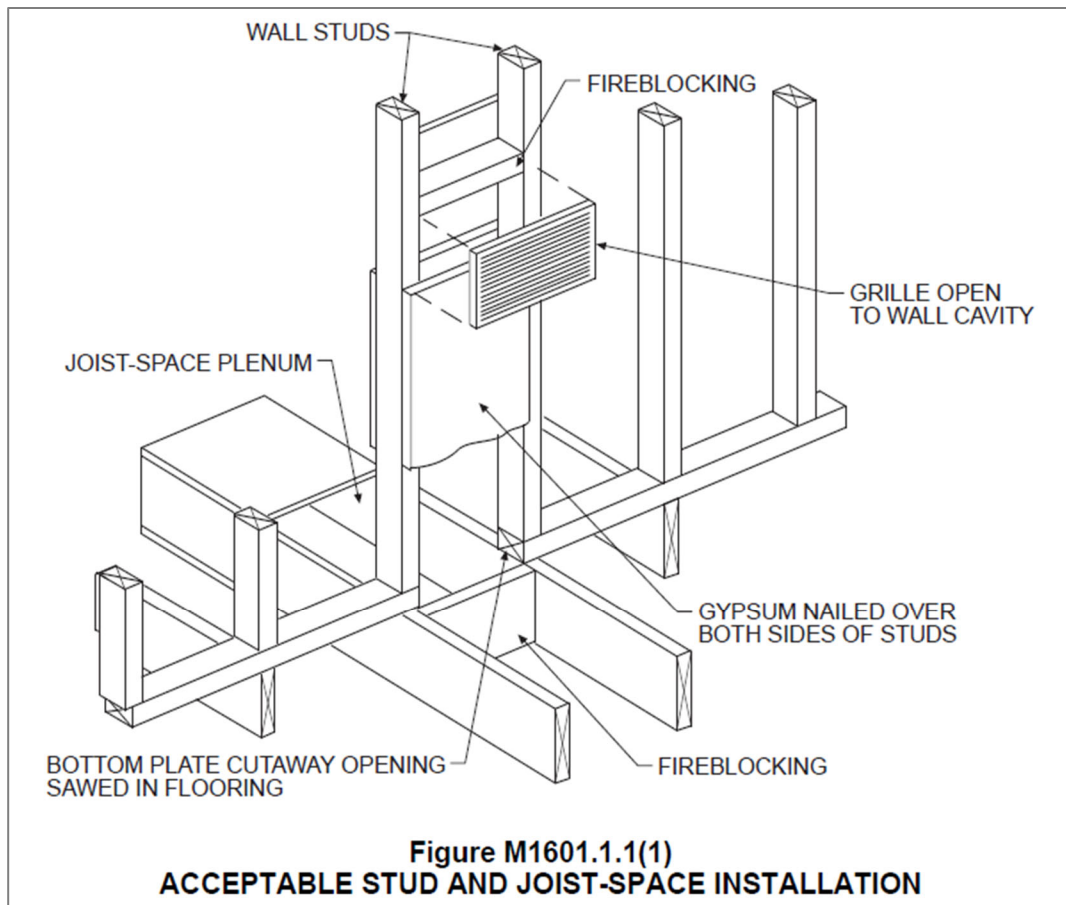

N1103.6 Mechanical Ventilation

Change Type: Addition

- Mechanical ventilation systems now require testing.

~~N1103.6.1 (R403.6.1)~~ N1103.6.2 (R403.6.2) Whole-house dwelling mechanical ventilation system fan efficacy. Fans used to provide whole-house dwelling mechanical ventilation shall meet the efficacy requirements of Table ~~N1103.6.1~~ N1103.6.2 at one or more rating points. Fans shall be tested in accordance with HVI 916 and listed. The airflow shall be reported in the product listing or on the label. Fan efficacy shall be reported in the product listing or shall be derived from the input power and airflow values reported in the product listing or on the label. Fan efficacy for fully ducted HRV, ERC, balanced, and in-line fans shall be determined at a static pressure of not less than 0.2 inch w.c. (49.82 Pa). Fan efficacy for ducted range hoods, bathroom, and utility room fans shall be determined at a static pressure of not less than 0.1 inch w.c. (24.91 Pa).

Exception: Where an air handler that is integral to tested and listed HVAC equipment is used to provide whole-house mechanical ventilation, the air handler shall be powered by an electronically commutated motor.

N1103.6.3 (R403.6.3) Testing. Mechanical ventilation systems shall be tested and verified to provide the minimum ventilation flow rates required by Section N1103.6. Testing shall be performed according to the ventilation equipment manufacturer's instructions, or by using a flow hood or box, flow grid, or other airflow measuring device at the mechanical ventilation fan's inlet terminals or grilles, outlet terminals or grilles, or in the connected ventilation ducts. Where required by the building official, testing shall be conducted by an approved third party. A written report of the results of the test shall be signed by the party conducting the test and provided to the building official.

Exception: Kitchen range hoods that are ducted to the outside with 6 inch (152 mm) or larger duct and not more than one 90-degree elbow or equivalent in the duct run.

N1104 Lighting Equipment

Change Type: Addition

- High-efficacy lighting is now required in all permanent lighting fixtures.
- New provisions require lighting controls for interior and exterior lighting.

N1104.1 (R404.1) Lighting equipment (~~Mandatory~~). Not less than 90 percent of the All permanently installed lighting fixtures, excluding kitchen appliance lighting fixtures, shall contain only high-efficacy lighting sources lamps.

N1104.2 (R404.2) Interior Lighting Controls. Permanently installed lighting fixtures shall be controlled with a dimmer, an occupant sensor control or another control that is installed or built into the fixture.

Exception: Lighting controls shall not be required for the following:

1. Bathrooms
2. Hallways
3. Exterior lighting fixtures
4. Lighting designed for safety or security

N1104.3 (R404.3) Exterior lighting controls. Where the total permanently installed exterior lighting power is greater than 30 watts, the permanently installed exterior lighting shall comply with the following:

1. Lighting shall be controlled by a manual on and off switch that permits automatic shut off actions.

Exception: Lighting serving multiple dwelling units.

2. Lighting shall be automatically shut off when daylight is present and satisfies the lighting needs.
3. Controls that override automatic shut off actions shall not be allowed unless the override automatically returns automatic control to its normal operation within 24 hours.

Section N1105 (R405) ~~Simulated Performance Alternative (Performance)~~ Total Building Performance and Table N1105.2

Change Type: Modification

- This section has been retitled and reorganized, and the terms “mandatory” and “prescriptive” are eliminated.
- All requirements applicable to this compliance path are now identified within Section N1105.
- New table N1105.2 lists the section number and title of all required provisions for this compliance path that appear elsewhere in the code.

General

N1101.13.5 Additional energy efficiency

N1101.14 Certificate

Building Thermal Envelope

N1102.1.1 Vapor Retarder

N1102.2.3 Eave Baffle

N1102.2.4.1 Access hatches and doors

N1102.2.10.1 Crawl space wall insulation installation

N1102.4.1.1 Installation

N1102.4.1.2 Testing

N1102.5 Max. fenestration *U*-factor and SHGC

Mechanical

N1103.1 Controls

N1103.3 Ducts, including N1103.3.1.1, except Sections N1103.3.2, N1103.3.3, and N1103.3.6

N1103.4 Mechanical system piping insulation

N1103.5.1 Heated water circulation and temperature maintenance systems

N1103.5.3 Drain water heat recovery units

N1103.6 Mechanical ventilation

N1103.7 Equipment sizing and efficiency rating

N1103.8 Systems serving multiple dwelling units

N1103.9 Snow melt system controls

N1103.10 Energy consumption of pools and spas

N1103.11 Portable spas

N1103.12 Residential pools and permanent residential spas

Electrical Power and Lighting Systems

N1104.1 Lighting equipment

N1104.2 Interior Lighting Controls

Reference to a code section includes all the relative subsections except as indicated in the table.

M1404.1 Refrigeration Cooling Equipment Compliance

Change Type: VA Modification (proposal RM1404.1 - 21)



- This code change updates multiple sections in Chapter 14 to reference the appropriate standards for various types of refrigeration cooling equipment (changes already approved/adopted in the 2024 IRC).

Updated Sections

- M1402.1
- M1403.1
- M1404.1
- M1412.1
- M1413.1

Referenced Standards

UL 474-2015: Standard for Safety Dehumidifiers

UL 484-2019: Standard for Room Air Conditioners

UL/CSA/ANCE 60335-2-40—2012 60335-2-40—2012 2019: Standard for Household and Similar Electrical Appliances, Safety Part 2-40: Particular Requirements for Motor-compressors for Electrical Heat Pumps, Air-Conditioners and Dehumidifiers

Section M1411 – Heating and Cooling Equipment

Change Type: VA Modification (proposal RM1411 – 21)

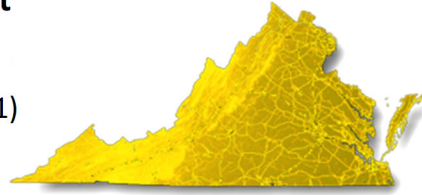

- This code change adds several new subsections to M1411.1 and deletes/updates several referenced standards related to the use of A2L refrigerants (aligns with the 2024 IRC).
- Full new subsections shown on next page.

Deleted/Updated Standards:

~~NMX-J-521/2-40-ANCE-2014/CAN/CSA-22.2 No. 60335-2-40-12/UL 60335-2-40~~

~~**UL 60335-2-40-2019/CAN/CSA/C22.2 No. 60335-2-40-2019**~~

~~**UL 60335-2-40 2019/CAN/CSA C22.2 No. 60335-2-40-19**~~

New subsections (full text on next page):

M1411.2 Refrigeration system listing.

M1411.3 Refrigeration system installation.

M1411.4 Field installed accessories.

M1411.5 Signs and identification.

M1411.6 Refrigerant charge.

M1411.7 Group A2L refrigerant piping testing.

Section M1411 – Heating and Cooling Equipment, continued

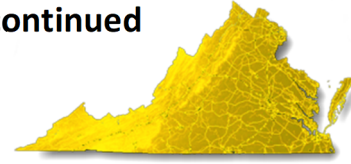

M1411.2 Refrigeration system listing. Refrigeration systems using Group A2L refrigerants shall be listed and labeled to UL 60335-2-40/CAN/CSA C22.2 No. 60335-2-40. Refrigeration systems using Group A1 refrigerants shall be listed to UL 60335-2-40/CAN/CSA C22.2 No. 6-335- 2-40 or UL 1995/CSA C22.2 No. 236. The equipment shall be installed in accordance with the listing.

M1411.3 Refrigeration system installation. Refrigeration systems shall be installed in accordance with the manufacturer's installation instructions. After installation, the manufacturer's installation instructions, owner's manuals, service manuals, and any other product literature provided with the equipment shall be attached to the indoor unit or left with the homeowner.

M1411.4 Field installed accessories. All Field installed accessories shall be installed in accordance with the accessory and equipment manufacturer's installation instructions. Accessories installed in the ductwork of Group A2L refrigeration systems shall not contain electric heating elements, open flames, or devices switching electrical loads greater than 2.5 kVA.

M1411.5 Signs and identification. Each refrigeration system using Group A2L refrigerant shall have the following information legibly and permanently indicated on a markable label provided by the equipment manufacturer.

1. Contact information of the responsible company that installed the refrigeration system, and
2. The system refrigerant charge and the refrigerant number.

M1411.6 Refrigerant charge. All refrigeration systems shall have refrigerant charge in compliance with the equipment manufacturer's installation instructions and the requirements of the listing. Group A2L refrigerant charge for an individual refrigeration system shall not exceed 34.5 lbs (15.7 kg).

M1411.7 Group A2L refrigerant piping testing. The piping system containing Group A2L refrigerant shall be tested in accordance with the manufacturer's installation instructions and the requirements of the listing.

M1505 *Balanced Ventilation System Credit*

Change Type: Modification

- A 30 percent reduction of airflow is permitted for *balanced ventilation* systems.

BALANCED VENTILATION. Any combination of concurrently operating mechanical exhaust and mechanical supply whereby the total mechanical exhaust airflow rate is within 10% of the total mechanical supply airflow rate.

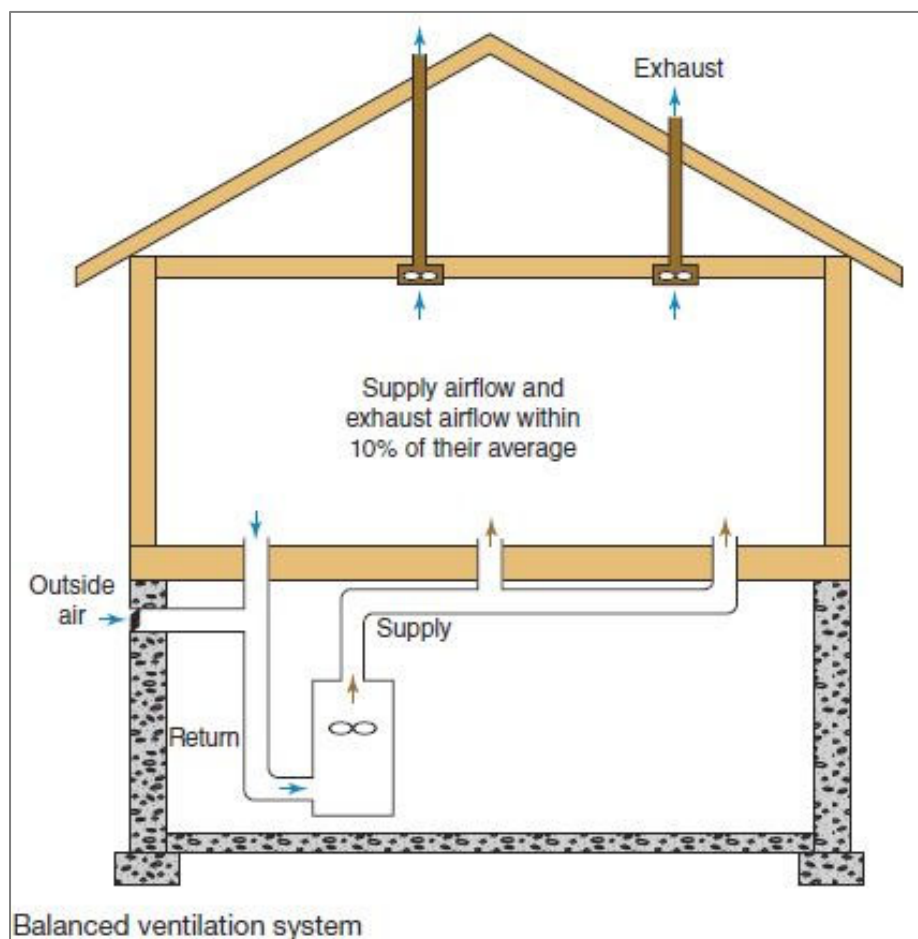

M1802.4 (801.21) Blocked Vent Switch for Oil-fired Appliances

Change Type: Addition

- Device will stop burner operation if venting system is obstructed.
- Requires a manual reset.
- Installed in accordance with the manufacturer's instructions.

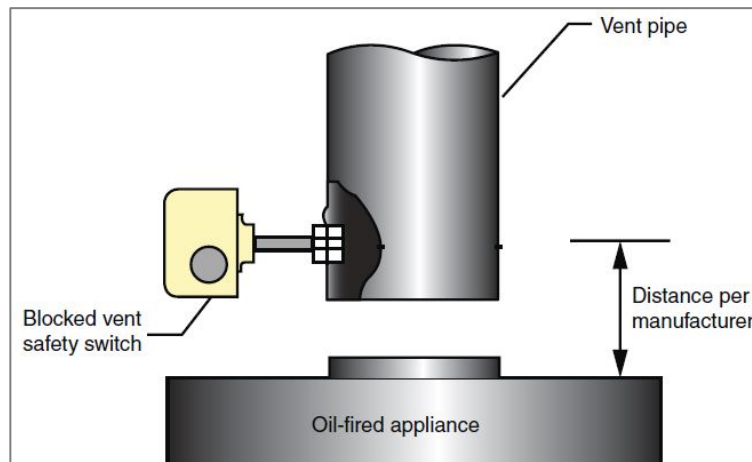

M2101 Hydronic Piping Systems Installation

Change Type: Modification

- Duplicates provisions from M2105 Ground-Source Heat Pump Loop Piping systems
- Now applies to all hydronic piping systems
- M2103 Floor heating piping rating ~~100~~ 80 pounds psi at 180°F
- M2105 Ground-Source Piping: pipe ends per manufacturer



G2403 (202) General Definitions

Change Type: Addition/Modification

- New definitions clarify terms that are used in the definition of “point of delivery” and a change to the definition of “service shutoff” coordinates with all of the relative definitions.

SERVICE METER ASSEMBLY. The meter, valve, regulator, piping, fittings and equipment installed by the service gas supplier before the point of delivery.

SERVICE SHUTOFF. A valve, installed by the serving gas supplier between the service meter or source of supply and the customer piping system point of delivery, to shut off the entire piping system.

SYSTEM SHUTOFF. A valve installed after the point of delivery to shut off the entire piping system.

POINT OF DELIVERY. For natural gas systems, the point of delivery is the outlet of the service meter assembly or the outlet of the service regulator or service shutoff valve where a meter is not provided. Where a system shutoff valve is provided at after the outlet of the service meter assembly, such valve shall be considered to be downstream of the point of delivery. For undiluted liquefied petroleum gas systems, the point of delivery shall be considered to be the outlet of the service pressure regulator, exclusive of line gas regulators, in the system.

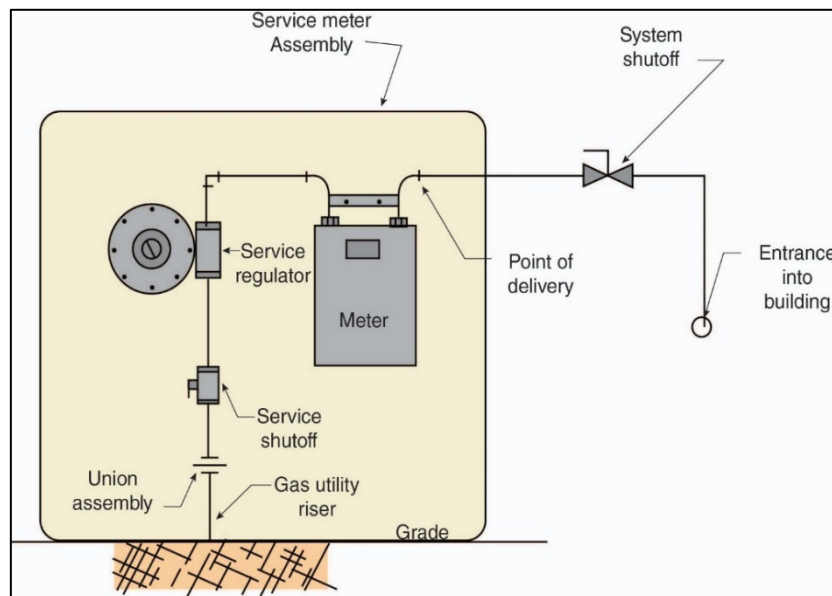

G2414.8.3 (403.8.3) Threaded Joint Sealing

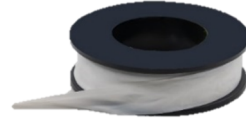

Change Type: Modification

- Text was revised to require the use of thread joint sealants (aka joint compounds, pipe dope, pipe tape).
- Thread sealants act primarily as a lubricant to allow the threads to form a tight metal-to-metal seal and any imperfections or voids in the threads are filled in by the thread sealant material.
- The most common thread sealants used today are pastes made with PTFE (Teflon) and Teflon tapes.

G2414.8.3 Threaded joint sealing. Threaded joints shall be made using a thread joint sealing material. Thread joint sealing materials shall be nonhardening and shall be resistant to the chemical constituents of the gases to be conducted through the piping. Thread joint sealing materials shall be compatible with the pipe and fitting materials on which the sealing materials are used.

G2415.5 (404.5) Fittings in Concealed Locations

Change Type: Clarification

- Plugs and caps have been added to the list of threaded fittings approved for concealed locations.



G2415.5 (404.5) Fittings in concealed locations. Fittings installed in concealed locations shall be limited to the following types:

1. Threaded elbows, tees, couplings, **plugs and caps.**
2. Brazed fittings.
3. Welded fittings.
4. Fittings listed to ANSI LC-1/CSA 6.26 or ANSI LC-4/CSA 6.32.

G2427.8 (503.8) Venting System Terminal Clearances

Change Type: Modification

- Through the wall vent terminal clearance distances have been placed in a new table for ease of use.
- In addition, new Figure G2427.8 illustrates the location and clearances for the vent terminations listed in the table. The identifying letter in the table corresponds to the lettered locations in the figure.

Exception: The clearances in Table G2427.8 shall not apply to the combustion air intake of a direct-vent appliance

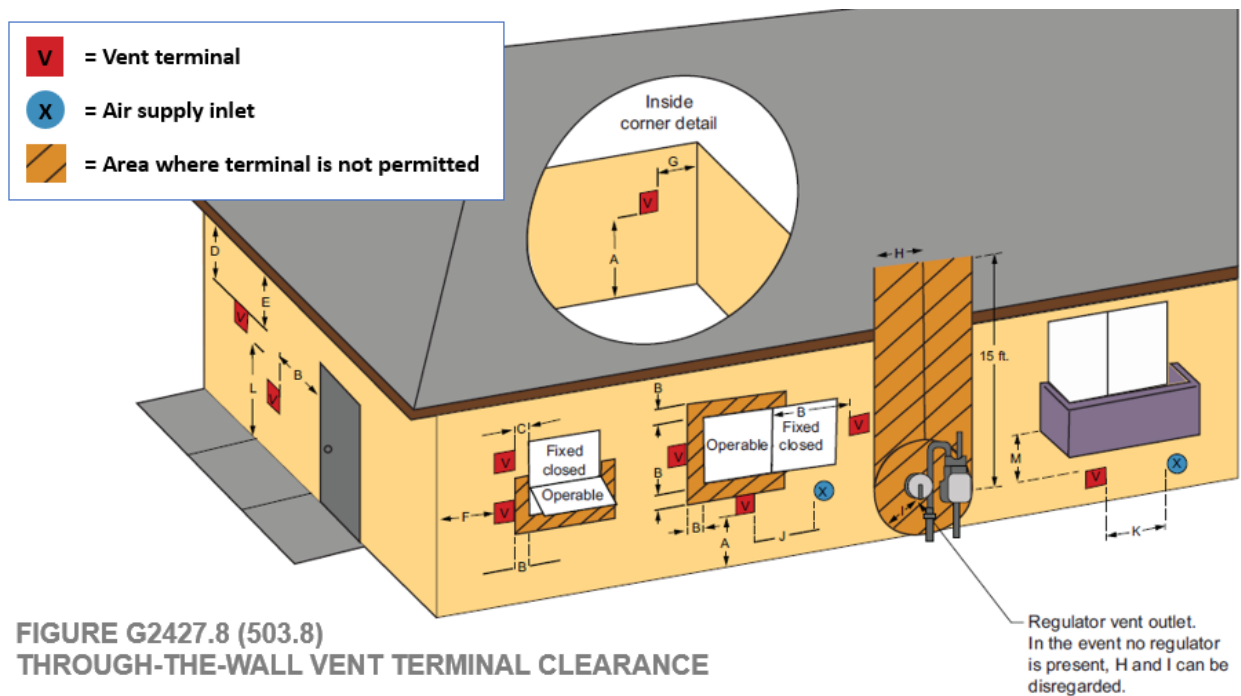

FIGURE G2427.8 (503.8)
THROUGH-THE-WALL VENT TERMINAL CLEARANCE

Table G2427.8 (503.8) - Venting System Terminal Clearances

Figure	Clearance Location	Minimum Clearance for Direct-Vent Terminals	Minimum Clearances for Non-Direct Vent Terminals
A	Clearance above finished grade level, veranda, porch, deck, or balcony	12 inches	
B	Clearance to window or door that is openable	<ul style="list-style-type: none"> ▪ 6" - appliances less than 10K Btu/hr ▪ 9" - appliances 10K up to 50K Btu/hr ▪ 12" - appliances 50K up to 150K Btu/hr <p>Appliances 150K Btu/hr, or more in accordance with the appliance manufacturer's instructions and not less than the clearances specified for Non-Direct Vent Terminals in row B</p>	4 ft. below or to side of opening or 1 foot above opening
C	Clearance to non-openable window	None unless otherwise specified by the appliance manufacturer	
D	Vertical clearance to ventilated soffit located above the terminal within a horizontal distance of 2' from the center line of the terminal	None unless otherwise specified by the appliance manufacturer	
E	Clearance to unventilated soffit	None unless otherwise specified by the appliance manufacturer	
F	Clearance to outside corner of building	None unless otherwise specified by the appliance manufacturer	
G	Clearance to inside corner of building	None unless otherwise specified by the appliance manufacturer	
H	Clearance to each side of center line extended above regulator vent outlet	3 ft. up to a height of 15 ft. above the regulator vent outlet	
I	Clearance to service regulator vent outlet in all directions	3 ft. for gas pressures up to 2 psi 10 ft. for gas pressures above 2 psi	
J	Clearance to non-mechanical air supply inlet to building and the combustion air inlet to any other appliance	Same clearance as specified for row B	
K	Clearance to a mechanical air supply inlet	10 ft. horizontally from inlet or 3 ft. above inlet	
L	Clearance above paved sidewalk or paved driveway located on public property	7 ft. and shall not be located above public walkways or other areas where condensate or vapor can cause a nuisance or hazard	
M	Clearance to underside of veranda, porch deck, or balcony	12 in. where the area beneath the veranda, porch deck or balcony is open on not less than two sides. The vent terminal is prohibited in this location where only one side is open.	

G2447.2 (623.2) Commercial Cooking Appliances Prohibited

Change Type: Modification

- The exception allowing a commercial cooking appliance in a dwelling unit when the installation is designed by an engineer has been removed from the code.

G2447.2 (623.2) Prohibited location. Cooking appliances designed, tested, listed and labeled for use in commercial occupancies shall not be installed within dwelling units or within any area where domestic cooking operations occur.

Exceptions Exception:

~~1. Appliances that are also listed as domestic cooking appliances.~~

~~2. Where the installation is designed by a licensed Professional Engineer, in compliance with the manufacturer's installation instructions.~~

P2503.5.1 Drain, Waste and Vent Systems Testing

Change Type: Modification

- The head pressure for a water test of DWV systems has increased to 10 feet (aligns with IPC) and **air vacuum testing is now permitted** for plastic piping DWV systems.

1. Water test. Each section shall be filled with water to a point not less than ~~5~~**10** feet (1524-3048 mm) above the highest fitting connection in that section, or to the highest point in the completed system. Water shall be held in the section under test for a period of 15 minutes. The system shall prove leak free by visual inspection.

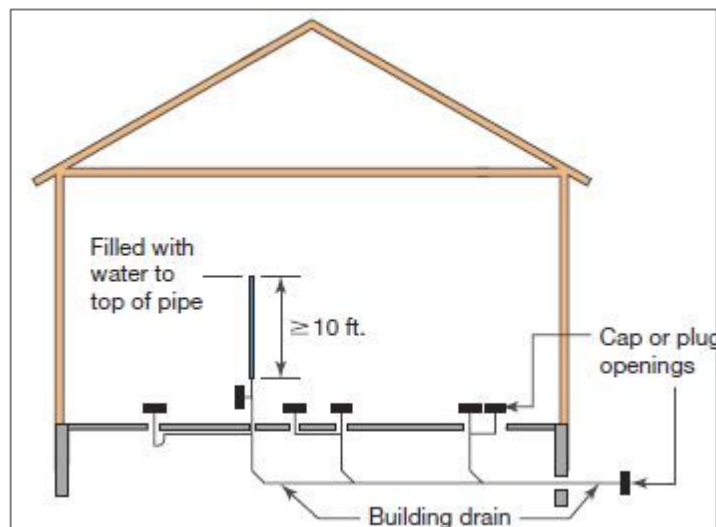

3. Vacuum Test. The portion under test shall be evacuated of air by a vacuum type pump to achieve a uniform gauge pressure of -5 pounds per square inch or a negative 10 inches of mercury column (-34 kPa). This pressure shall be held without the removal of additional air for a period of 15 minutes.

P2708.4, P2713.3 Shower and Bathtub Control Valves

Change Type: Clarification

- Addresses field adjustment and access to shower control valves.
- Lower flow shower heads need to be compatible with the shower control mixing valve.



P2708.4 Shower control valves. Individual shower and tub/shower combination valves shall be equipped with control valves of the pressure-balance balanced-pressure, thermostatic-mixing or combination balanced-pressure balance/thermostatic-mixing valve types with a high limit stop in accordance with /thermostatic valves that conform to the requirements of ASSE 1016/ASME A112.1016/CSA B125.16 The high limit stop shall be set to limit the water temperature to not greater than 120°F (49°C), or ASME A112.18.1/CSA B125.1. Shower control valves shall be rated for the flow rate of the installed showerhead. Such valves shall be installed at the point of use. Shower and tub/shower combination valves required by this section shall be equipped with a means to limit the maximum setting of the valve to 120°F (49°C), which shall be field adjusted in accordance with the manufacturer's instructions to provide water at a temperature not to exceed 120°F. In-line thermostatic valves shall not be used-utilized for compliance with this section.

P2713.3 Bathtub and whirlpool bathtub valves. Hot water supplied to bathtubs Bathtub and whirlpool bathtubs bathtub valves shall be limited to a temperature of not greater than 120°F (49°C) have or be supplied by a water-temperature limiting device that conforms to ASSE 1070/ASME A112.1070/CSA B125.70 or CSA B125.3, except where such protection is otherwise provided by a valves are combination tub/shower valves in accordance with Section P2708.4. The water temperature limiting device required by this section shall be equipped with a means to limit the maximum setting of the device to 120°F (49°C), and, where adjustable, shall be field adjusted in accordance with the manufacturer's instructions to provide hot water at a temperature not to exceed 120°F (49°C). Access shall be provided to water temperature limiting devices that conform to ASSE 1070/ASME A112.1070/CSA B125.70.

Exception: Access is not required for non-adjustable water temperature limiting devices that conform to ASSE 1070/ASME A112.1070/ CSA B125.70 and are integral with a fixture fitting, provided that the fixture fitting itself can be accessed for replacement.

P2905.3 Length of Hot Water Piping to Fixtures

Change Type: Addition

- Limits the length of hot water piping serving fixtures to 100 ft. (IPC = 50 ft.)

P2905.3 Hot water supply to fixtures. The developed length of hot water piping, from the source of hot water to the fixtures that require hot water, shall not exceed 100 feet (30,480 mm). Water heaters and recirculating system piping shall be considered to be sources of hot water.

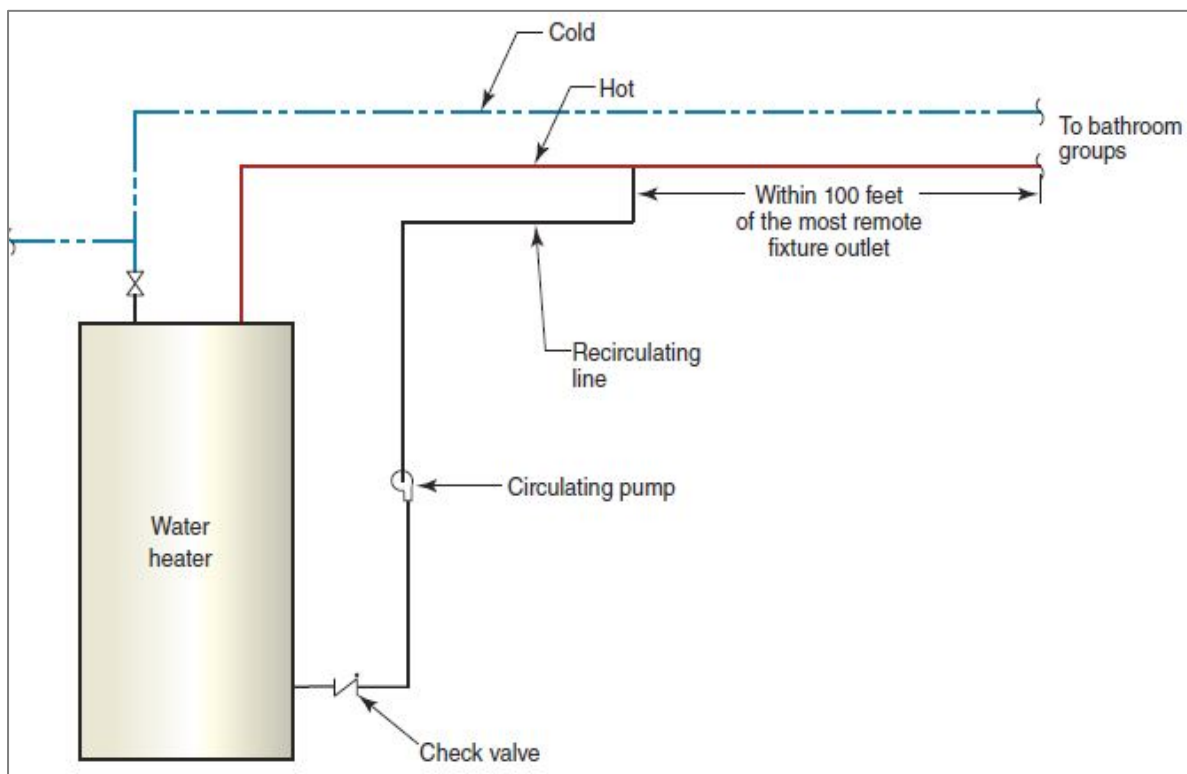

P2906.9.1.2 (VA) Solvent cementing (CPVC piping)

Change Type: Modification (VA)

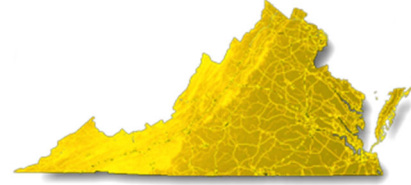

- This VA amendment adds the option for solvent **green in color** for one-step solvent cementing of CPVC piping and joints when the other conditions for omitting primer are met.
- One-step CPVC cement can now be yellow, red, OR green.
- Green cement stands out better on CPVC pipe and fittings, allowing for installers and inspectors to more easily identify any joints that were not cemented.

P3005.2.10.1 (708.1.6) Removable Fixture Traps as Cleanouts

- Removable traps and removeable fixtures with integral traps are acceptable for use as cleanouts.

P3005.2.10.1 (708.1.6) Cleanout Equivalent. A fixture trap or a fixture with an integral trap, removable without altering the concealed piping shall be acceptable as a cleanout equivalent.

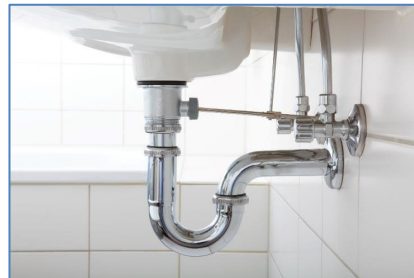

E3601.8 Emergency Service Disconnects [NEC 230.82(3), 230.85]

Change Type: Addition

- An emergency service disconnect is required in a readily accessible outdoor location.

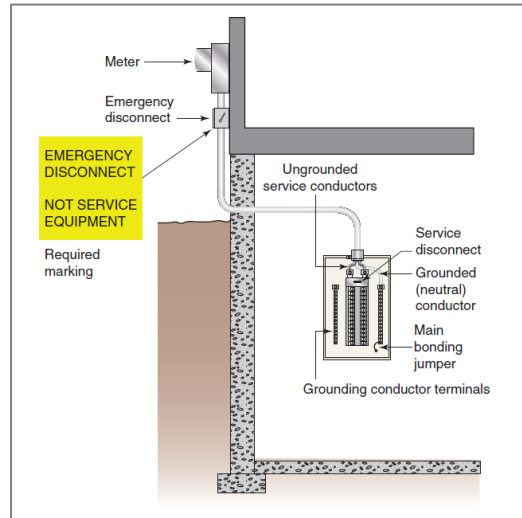

E3601.8 Emergency disconnects. For one- and two- family dwelling units, all service conductors shall terminate in disconnecting means having a short-circuit current rating equal to or greater than the available fault current, installed in a readily accessible outdoor location. If more than one disconnect is provided, they shall be grouped. Each disconnect shall be one of the following.

1. Service disconnects marked as follows: EMERGENCY DISCONNECT, SERVICE DISCONNECT
2. Meter disconnect switches that have a short-circuit current rating equal to or greater than the available fault current and all metal housings and service enclosures are grounded in accordance with Section E3908.7 and bonded in accordance with Section E3609. A meter disconnect switch shall be capable of interrupting the load served and shall be marked as follows: EMERGENCY DISCONNECT, METER DISCONNECT, NOT SERVICE EQUIPMENT
3. Other listed disconnect switches or circuit breakers on the supply side of each service disconnect that are suitable for use as service equipment and marked as follows: EMERGENCY DISCONNECT, NOT SERVICE EQUIPMENT

Markings shall comply with Section E3404.12.

[230.82(3), 230.85]

E3606.5 Service Surge-Protective Device [230.67]

Change Type: Addition

- A surge-protective device (SPD) is now required at the service panel.

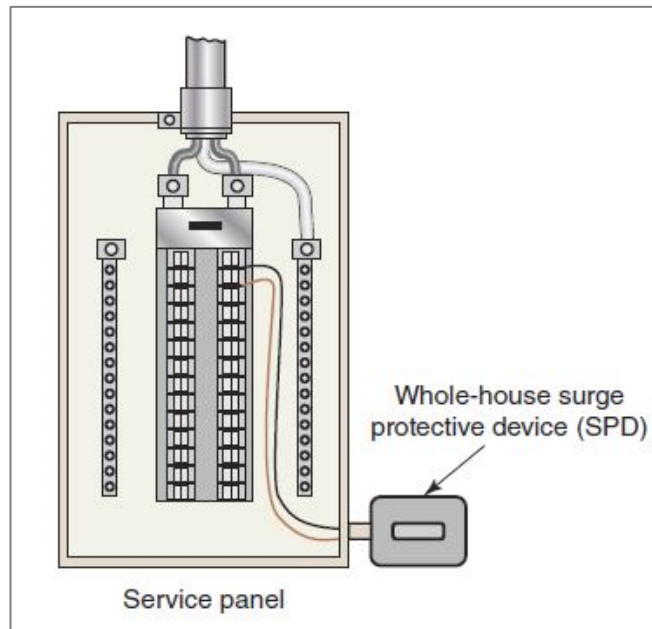

E3606.5 Surge protection. All services supplying one and two-family dwelling units shall be provided with a surge-protective device (SPD) installed in accordance with Sections E3606.5.1 through E3606.5.3.

E3606.5.1 Location. The SPD shall be an integral part of the service equipment or shall be located immediately adjacent thereto.

Exception: The SPD shall not be required to be located in the service equipment if located at each next-level distribution equipment downstream toward the load.

E3606.5.2 Type. The SPD shall be a Type 1 or Type 2 SPD.

E3606.5.3 Replacement. Where service equipment is replaced, all of the requirements of this section shall apply.

[230.67]

E3703.4 Bathroom Branch Circuits [210.1(C)(3)]

Change Type: Clarification

- Only the required bathroom receptacle outlets or those serving a countertop need to be on the dedicated 20-amp bathroom circuit.

E3703.4 Bathroom branch circuits. A minimum of one 20-ampere branch circuit shall be provided to supply bathroom receptacle outlet(s) required by Section E3901.6 and any countertop or similar work surface receptacle outlets. Such circuits shall have no other outlets. [210.11(C)(3)]

Exception: Where the 20-ampere circuit supplies a single bathroom, outlets for other equipment within the same bathroom shall be permitted to be supplied in accordance with Section E3702. [210.11(C) (3) Exception]

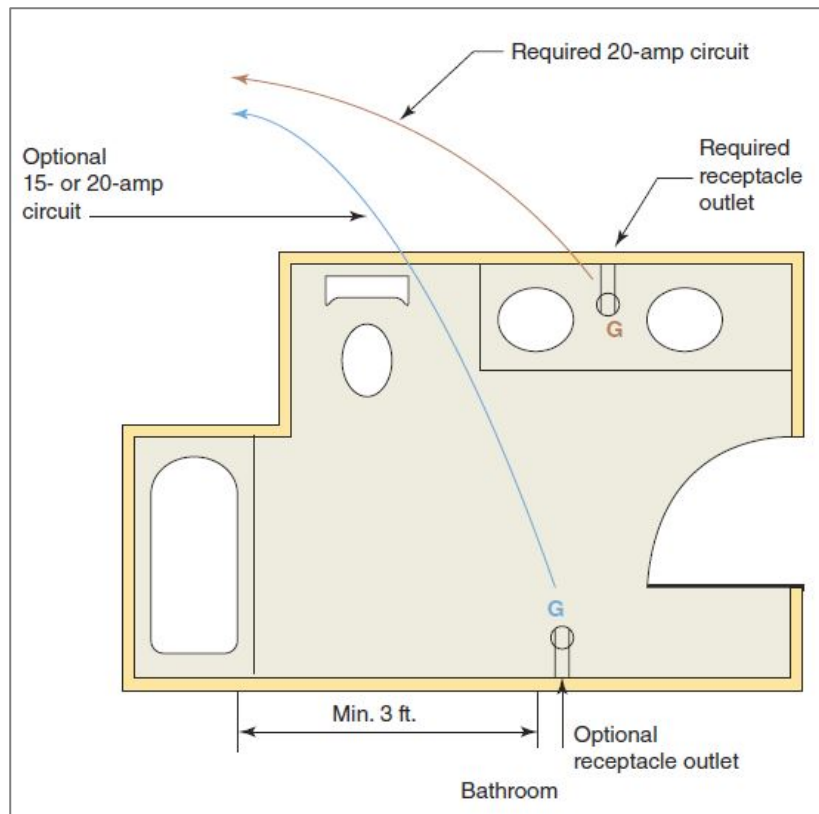

E4002.11 Bathtub and Shower Space [406.9(C)]

Change Type: Modification

- Receptacle outlet(s) located in the area around a bathtub or shower stall have been revised to include a restricted “zone” with an exception added for smaller space bathrooms.

E4002.11 Bathtub and shower space. Receptacles shall not be installed within a **zone measured 3 ft horizontally and 8 ft vertically** from the top of the bathtub rim or shower stall threshold. The identified zone is all encompassing and shall include the space directly over the tub or shower stall.

Exception: In bathrooms with less than the required zone, the receptacle(s) shall be permitted to be installed opposite the bathtub rim or shower stall threshold on the farthest wall in the room. [406.9(C)]

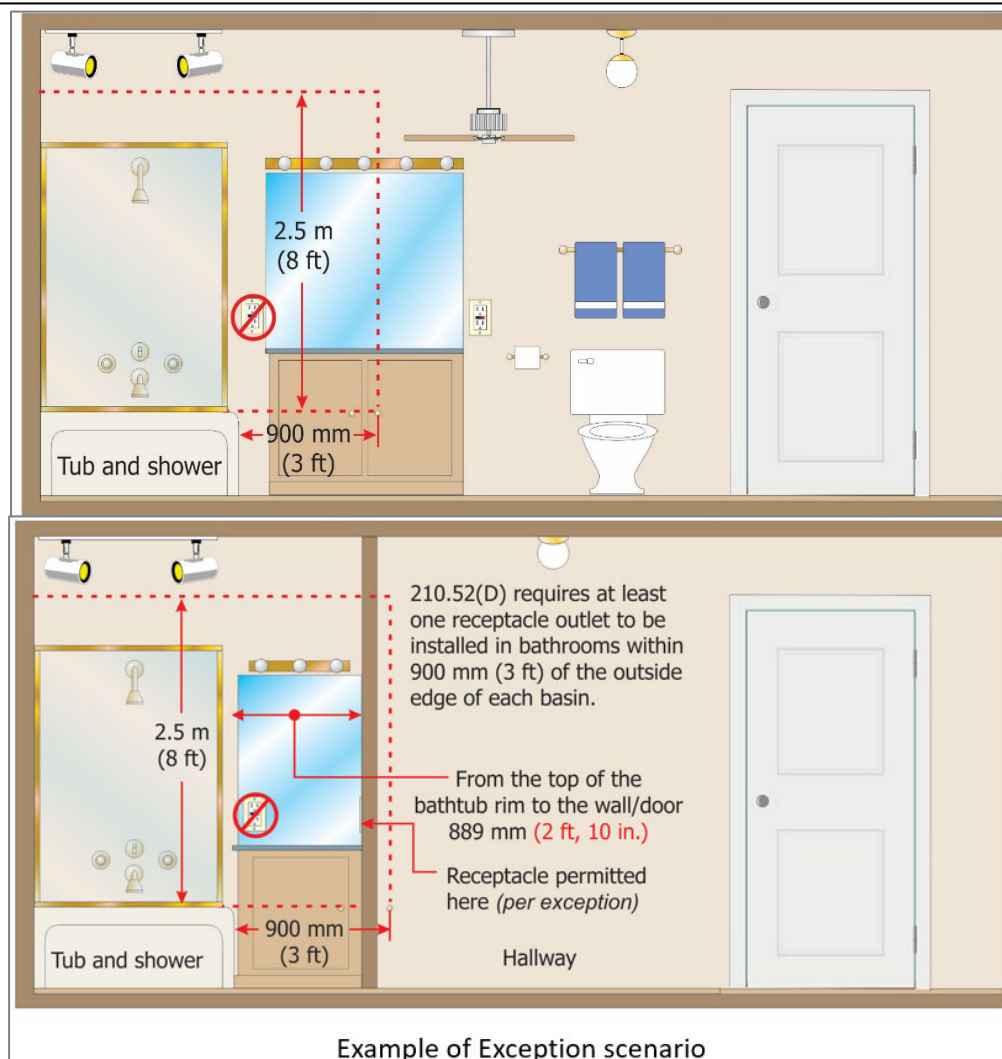

E3703.5 Garage Branch Circuits [210.11(C)(4)]

Change Type: Modification

- Only the required receptacle outlets must be on the 20-amp dedicated circuit for garages.

E3703.5 Garage Branch Circuits. In addition to the number of branch circuits required by other parts of this section, not less than one 120-volt, 20-ampere branch circuit shall be installed to supply receptacle outlets required by Section E3901.9 in attached garages and in detached garages with electric power. This circuit shall not have other outlets.

Exception: This circuit shall be permitted to supply readily accessible outdoor receptacle outlets.

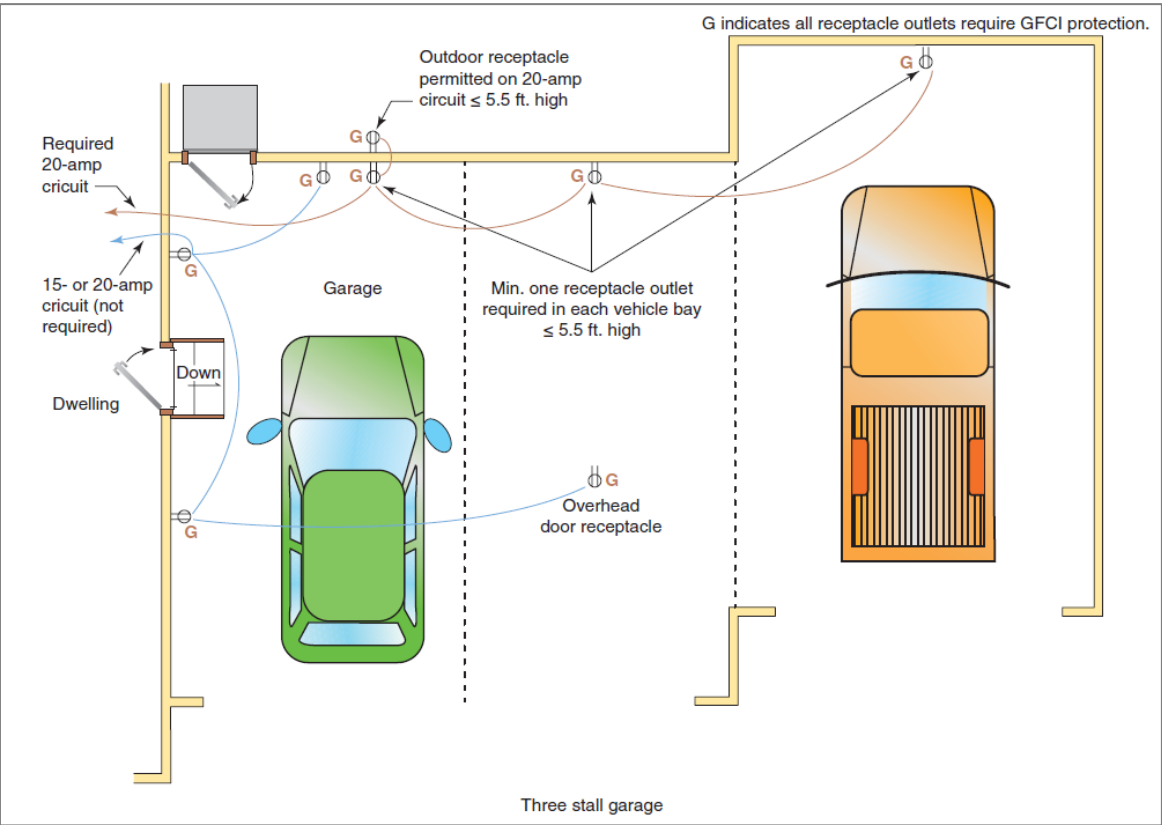

E3901.4 Kitchen Countertop and Work Surface Receptacles [210.52 (C)]

Change Type: Modification

- The number of receptacle outlets required for peninsular and island countertops in kitchens is determined by the area of the countertop surface.
- The code also clarifies that countertop and work surface receptacles in kitchen areas cannot be counted as a required general-purpose wall space receptacle outlet.

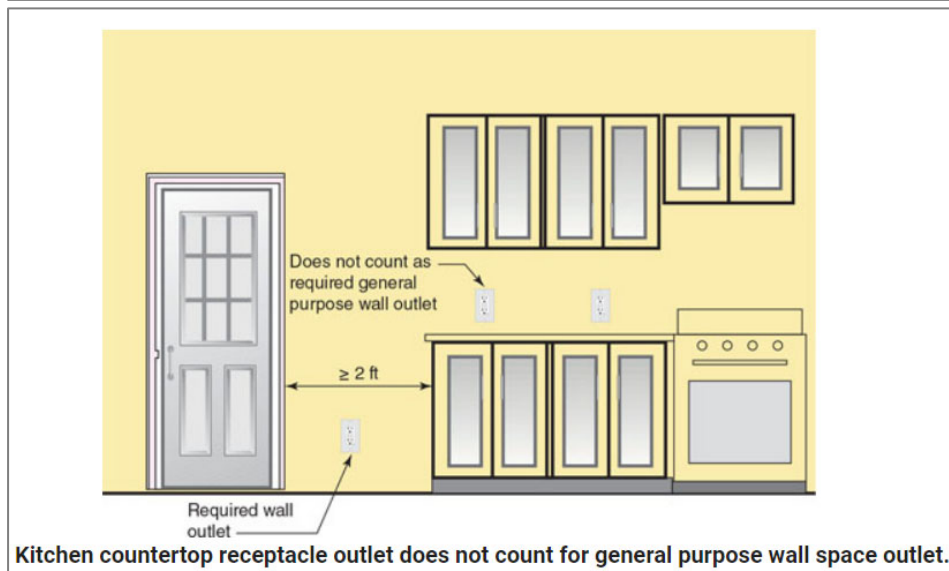
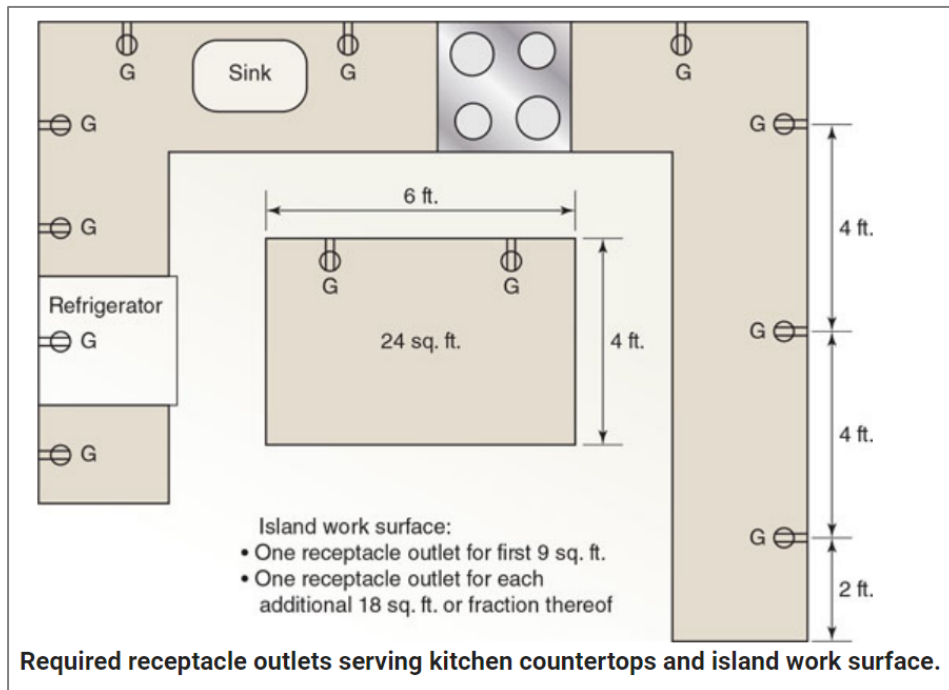

E3902 GFCI Protection for 250-Volt Receptacles [210.8(A) – multiple subsections, 210.8(E)]

Change Type: Modification

- Ground-fault circuit-interrupter (GFCI) protection is required for up to 250-volt receptacles in the areas previously identified as requiring GFCI protection for 125-volt receptacles.
- The 20-amp limitation has been removed.

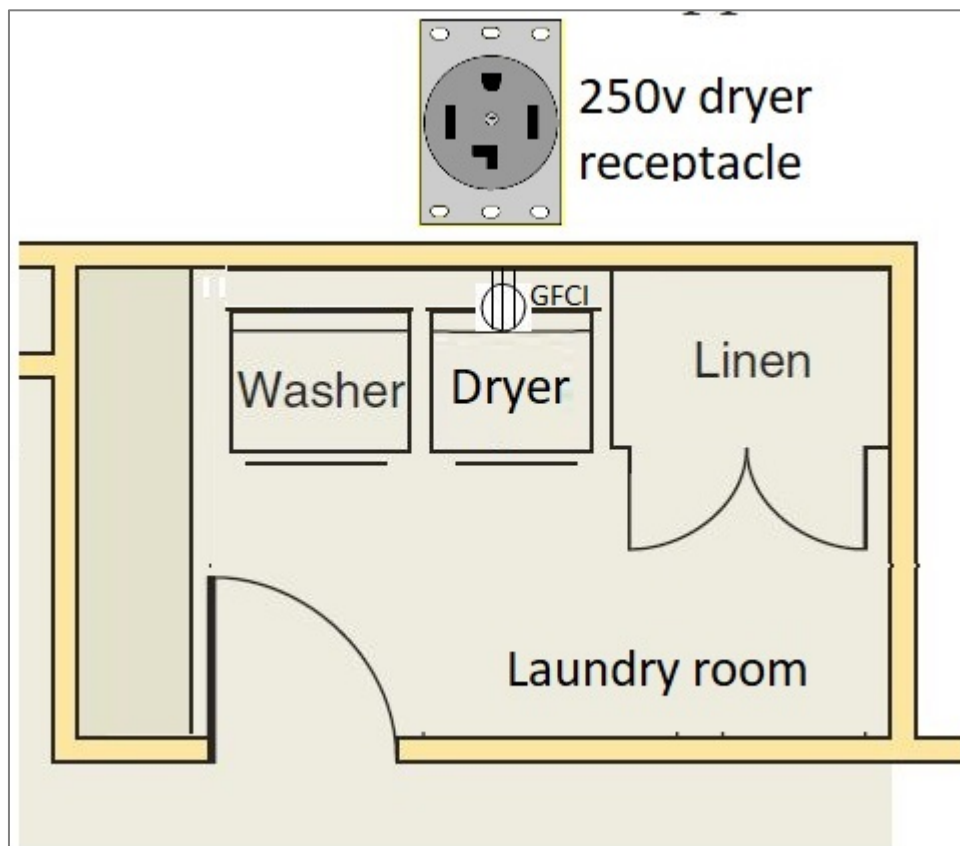

E3902.5 GFCI Protection for Basement Receptacles [210.8(A)(5)]

Change Type: Modification

- The requirement for GFCI protection in unfinished basement areas has been expanded to include **all basement areas** – whether finished or unfinished.

E3902.5 Unfinished bBasement receptacles. 125-volt **through 250-volt**, single-phase, 15- and 20-ampere receptacles installed in unfinished basements **and supplied by single-phase branch circuits rated 150 volts or less to ground** shall have ground-fault circuit-interrupter protection for personnel. For purposes of this section, unfinished basements are defined as portions or areas of the basement not intended as habitable rooms. [210.8(A)(5)]

Exception: A receptacle supplying only a permanently installed fire alarm or burglar alarm system. Receptacles installed in accordance with this exception shall not be considered as meeting the requirement of Section E3901.9. [210.8(A)(5) Exception]

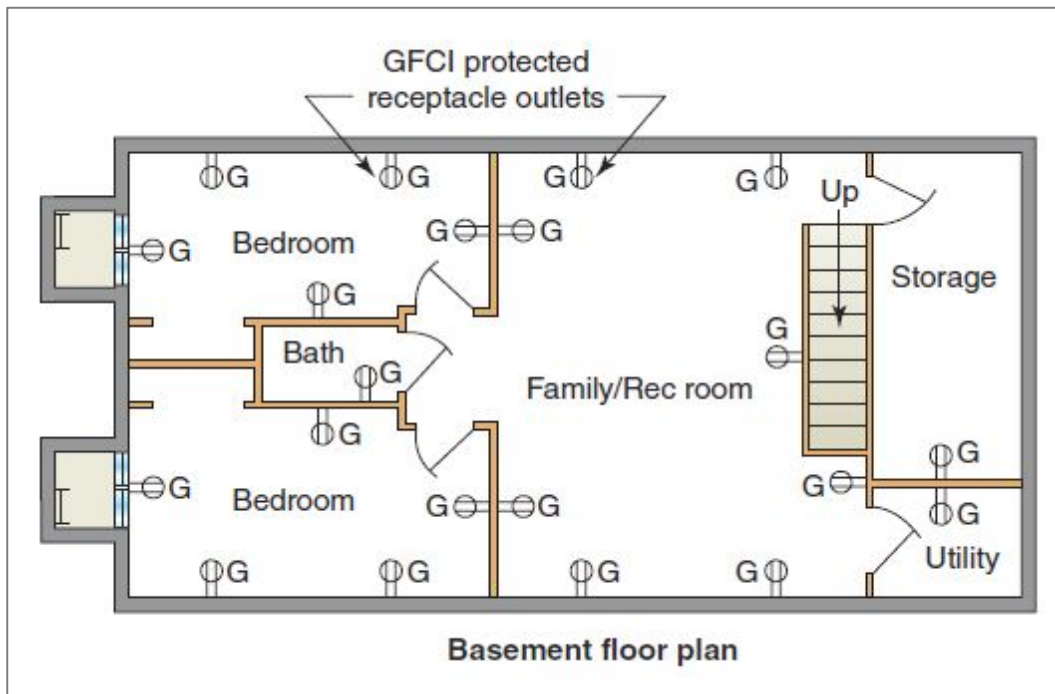

E3902.10 GFCI Protection for Indoor Damp and Wet Locations [210.8(A)(11)]

Change Type: Addition

- GFCI protection is now required for damp and wet locations (not already included in the other specific locations requiring GFCI protection)

E3902.10 Indoor damp and wet locations. 125-volt through 250-volt, receptacles installed in indoor damp and wet locations and supplied by single-phase branch circuits rated 150 volts or less to ground shall have ground-fault circuit-interrupter protection for personnel. [210.8(A)(11)]

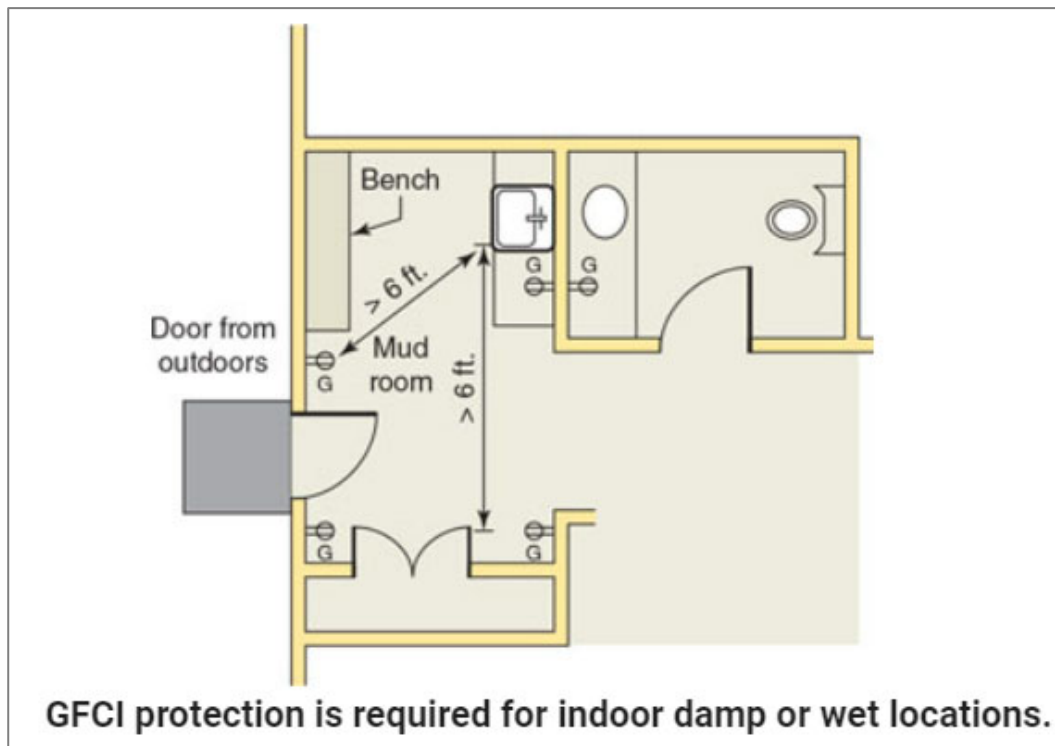

VA Deletes Section E3902.17 in its Entirety (GFCI Protection for Outdoor Outlets)

Change Type: VA Deletion (proposals RE2701.1.1-21 and RE3902.17-21)

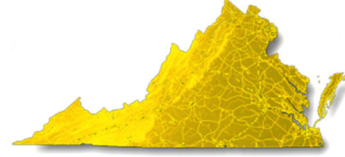

- Currently, separate standards for the tripping current of GFCI devices and the allowable leakage current of air conditioner condenser units **creates an incompatibility issue.**
- If GFCI protection is required while the incompatibility issue remains, there is a higher risk of people being adversely impacted by exposure to extreme temperatures due to nuisance tripping than the risk of people being exposed to a leakage current that could cause injury or harm.

E3902.17 Outdoor outlets.

~~All outdoor outlets, other than those covered in the exception to Section E3902.3, that are supplied by single-phase branch circuits rated 150 volts to ground or less, 50 amperes or less, shall have ground-fault circuit-interrupter protection for personnel. [210.8(F)]~~

~~**Exception:** Ground-fault circuit-interrupter protection shall not be required on lighting outlets other than those covered in Section E3902.15. [210.8(F) Exception]~~

(Appendix) AF104 Radon Testing

Change Type: Addition

- Procedures for Radon testing are added to Appendix F.
- For use by localities where radon-resistant construction is required.

SECTION AF104 - TESTING

AF104 Testing. Where radon-resistant construction is required, radon testing shall be as specified in Items 1 through 11:

1. Testing shall be performed after the dwelling passes its air tightness test.
2. Testing shall be performed after the radon control system and HVAC installations are complete. The HVAC system shall be operating during the test. Where the radon system has an installed fan, the dwelling shall be tested with the radon fan operating.
3. Testing shall be performed at the lowest occupied floor level, whether or not that space is finished. Spaces that are physically separated and served by different HVAC systems shall be tested separately.
4. Testing shall not be performed in a closet, hallway, stairway, laundry room, furnace room, bathroom or kitchen.
5. Testing shall be performed with a commercially available radon test kit or testing shall be performed by an approved third party with a continuous radon monitor. Testing with test kits shall include two tests, and the test results shall be averaged. Testing shall be in accordance with this section and the testing laboratory kit manufacturer's instructions.
6. Testing shall be performed with the windows closed. Testing shall be performed with the exterior doors closed, except when being used for entrance or exit. Windows and doors shall be closed for at least 12 hours prior to the testing.
7. Testing shall be performed by the builder, a registered design professional, or an approved third party.
8. Testing shall be conducted over a period of not less than 48 hours or not less than the period specified by the testing device manufacturer, whichever is longer.
9. Written radon test results shall be provided by the test lab or testing party. The final written test report with results less than 4 picocuries per liter (pCi/L) shall be provided to the code official.
10. Where the radon test result is 4 pCi/L or greater, the fan for the radon vent pipe shall be installed as specified in Sections AF103.9 and AF103.12.
11. Where the radon test result is 4 pCi/L or greater, the system shall be modified and retested until the test result is less than 4 pCi/L.

Exception: Testing is not required where the occupied space is located above an unenclosed open space.

Appendix AW – 3D Construction

Change Type: Addition

- Appendix AW adds requirements for 3D printed homes.



2021 Virginia Construction Code

2021 IBC Referenced

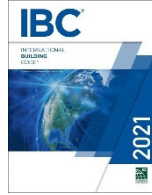
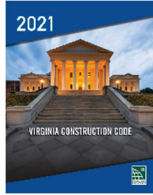

202 Atrium

The new definition clarifies which floor openings are to be considered attics. Increases the threshold by one story in all occupancies other than I-2 and I-3.

- Definition simplified to address only 2 conditions:
 - Vertical space enclosed at the top, and
 - Connects 3 or more stories in all occupancies other than Groups I-2 and I-3 (two or more stories).
- Other text was deleted or relocated to Chap 7
- Increases threshold from two to three stories for most occupancies - no change in application will typically occur.
- Clarifies allowance in 712.9 permitting 2-story opening conditions without regulation as an atrium

ATRIUM. An opening A vertical space that is closed at the top, connecting two or more stories other than enclosed stairways, elevators, hoistways, escalators, plumbing, electrical, air conditioning or other equipment, which is closed at the top and not defined as a mall. Stories, as used in this definition, do not include balconies within assembly groups or mezzanines that comply with Section 505 in Group I-2 and I-3 occupancies or three or more stories in all other occupancies.



202 Penthouse

The definition of penthouse has been slightly revised to ensure that enclosures extended to the roof in order to house stairways are considered as penthouses.

- Clarifies that enclosures extended to roof to house stairways are to be considered as penthouses, per 1511.
 - Previously, intended to be included in reference to “vertical shaft openings”
- Confirms that extension of stair enclosure above roof level is to be considered as a portion of the story directly below the roof deck below, and does not create:
 - An additional story
 - Additional building area
 - Additional fire area
 - Additional building height
 - Subject to limitations

PENTHOUSE. An enclosed, unoccupied rooftop structure used for sheltering mechanical and electrical equipment, tanks, elevators and related machinery, stairways and vertical shaft openings.

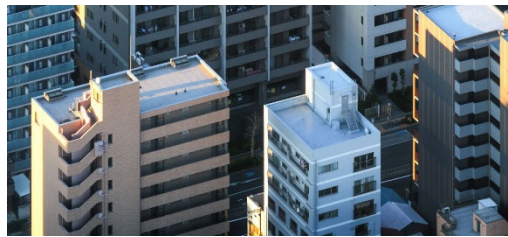

202 Puzzle Room

The puzzle room, a relatively new type of special amusement area, is now specifically regulated by the code and a related definition provides the necessary scoping to address its unique hazards.

- AKA “escape room”
- In a puzzle room, occupants are encouraged to solve a challenge to escape from a room or, more commonly, a series of rooms.
- Of particular importance is the recognition by the definition that a puzzle room is considered as a “special amusement area” (formerly special amusement building).
- Special amusement areas are regulated under 411.



PUZZLE ROOM. A puzzle room is a type of special amusement area in which occupants are encouraged to solve a challenge to escape from a room or series of rooms.

202 Secondary Structural Members

Helps clarify the difference between different types of structural members, which should help with applying the appropriate fire-resistance-rating requirements.

- Clarification to address new technology and remove outdated terminology
- Components built into an assembly that supports a portion of a floor, roof or only their own self-weight are considered as secondary members, including:
- Roof trusses connected to a girder truss
- Roof purlins and subpurlins connect to beams
- Floor joists and trusses
- Nonbearing walls
- Bracing in the roof, floor or walls specifically designed to resist wind or seismic loads and is redundant for gravity systems.



SECONDARY STRUCTURAL MEMBERS. The following structural members shall be considered secondary members and not part of the primary structural frame:

1. Structural members not having direct connections to the columns.
2. Members of the floor construction and roof construction not having direct connections to the columns.
3. Bracing members ~~other than those~~ that are not designated as part of the primary structural frame or bearing wall.

Definitions relating to Resiliency Updated



Definitions updated as part of the Resiliency Sub-workgroup efforts to better correlate with the National Flood Insurance Program.



BASE FLOOD ELEVATION. The elevation of the base flood, including wave height, relative to the National Geodetic Vertical Datum (NGVD), North American Vertical Datum (NAVD) or other datum specified on the Flood Insurance Rate Map (FIRM)-, and as shown in the Flood Insurance Study.

COASTAL HIGH HAZARD AREA. Area within the special flood hazard area extending from offshore to the inland limit of a ~~primary dune~~ Coastal Primary Sand Dune, as defined by state code (Code of Virginia Title 28.2), along an open coast and any other area that is subject to high velocity wave action from storms or seismic sources, and shown in either the Flood Insurance Study, or on a the Flood Insurance Rate Map (FIRM) or other flood hazard map as velocity Zone V, VO, VE or V1-30 (areas subject to wave heights of 3 feet (914.4 mm) or more).

FLOOD HAZARD AREA. The greater of the following two areas:

1. The area within a flood plain subject to a 1-percent or greater chance of flooding in any year (also known as the 100-year floodplain).
2. The area designated as a flood hazard area on a community's flood hazard map, or otherwise legally designated-, including areas in either the Flood Insurance Study or on the Flood Insurance Rate Map (FIRM) and including areas added to account for future flooding conditions based on the locally adopted sea level rise projected to occur by 2070.

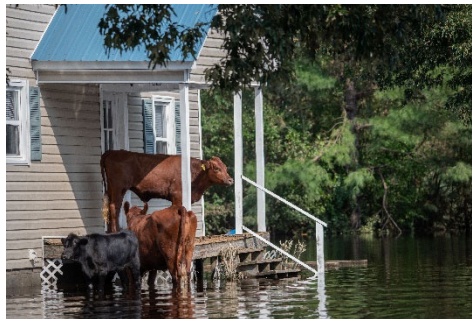

~~FLOOD OR FLOODING. A general and temporary condition of partial or complete inundation of normally dry land from:~~

1. The overflow of inland or tidal waves ~~A general and temporary condition of partial or complete inundation of normally dry land from either of the following:~~
 - 1.1 The overflow of inland or tidal waves
 - 1.2 The unusual and rapid accumulation or runoff of surface waters from any source.
2. ~~The unusual and rapid accumulation or runoff of surface waters from any source.~~ The collapse or subsidence of land along the shore of a lake or other body of water as a result of erosion or undermining caused by waves or currents of water exceeding anticipated cyclical levels or suddenly caused by an unusually high water level in a natural body of water, accompanied by a severe storm, or by an unanticipated force of nature such as flash flood or an abnormal tidal surge, or by some similarly unusual and unforeseeable event which results in flooding as defined in subsection (1.1) of this definition.
3. Mudflows which are proximately caused by flooding as defined in subsection (1.2) of this definition and are akin to a river of liquid and flowing mud on the surface of normally dry land areas, as when earth is carried by a current of water and disposed along the path of the current.

SPECIAL FLOOD HAZARD AREA. The land area subject to flood hazards and shown on a Flood Insurance Rate Map or ~~other flood hazard map~~ the Flood Insurance Study as Zone A, AE, A1-30, A99, AR, AO, AH, V, VO, VE or V1-30.

306.2 Group F-1 Occupancy

- Two new items added to listing of Group F-1 occupancies.
- Energy storage systems (ESS) in dedicated-use buildings.
 - Administrative/support areas without ESS permitted where $\leq 10\%$ of floor area of the story where located
 - In mixed-occupancy buildings, ESS to be classified the same as major occupancy
 - Previously would often be classified as Group H-2, however new IFC provisions reduce potential hazards
- Water/sewer treatment plants
 - Typically contain materials in use that would warrant a Group H classification should MAQs be exceeded.
- Part of a group of changes relating to Energy Storage Systems (ESS)



311.2, 311.3 Alcoholic Beverage Storage

The proper occupancy classification for the storage of beverages, specifically alcohol beverages, has been clarified for both the Group S-1 and S-2 categories.



- Storage of alcoholic beverages with over 16% alcohol content now classified as Group S-1 occupancy.
 - Previously not specifically addressed.
- Where alcohol content does not exceed 16%, classification continues to be Group S-2.
 - Limit that containers be only metal, glass or ceramic has been deleted to allow for wooden barrels and casks.
 - IFC safeguards no longer warrant restriction to only noncombustible containers.

310.6 Residential Group R-5



This seeks to clarify some confusion regarding the three-story threshold for VRC structures. There is no change in the scope of the VRC.



- Scoping for R-5 added to the VCC
- References to I-codes replaced with V-codes
- Replaces reference to IRC R101.2

404.1 Scope of Atrium Provisions

Application of the atrium provisions have been clarified and several means of egress provisions have been relocated to Chapter 10.

- The application of the atrium provisions of 404 has been clarified by addressing three key concepts:
 - Provisions of 404 applicable to all buildings containing atriums, except:
 - Atrium conditions not applicable to vertical openings that comply with specified protection methods of 712.1
 - Atriums not permitted in Group H buildings
- Exit access travel distance provisions relocated to Ch. 10 due to their evaluation as part of the general travel distance provisions



404.5 Smoke Control in Atriums

In the evaluation of whether a smoke control system is required for an atrium condition, vertical opening protection consisting of a combination of both the atrium and a shaft enclosure is now recognized.

- New allowance permits a combination vertical opening condition consisting of both an atrium and a shaft enclosure without the requirement for a smoke control system
- Smoke control system not required for atriums connecting more than two stories where:
 - Only the two lowest stories permitted to be open to the atrium, and
 - All stories above the lowest two stories to be separated from the atrium in accordance with shaft enclosure provisions.
- Recognizes that the combination of shaft enclosure and atrium condition provides the necessary degree of separation expected between multiple stories.

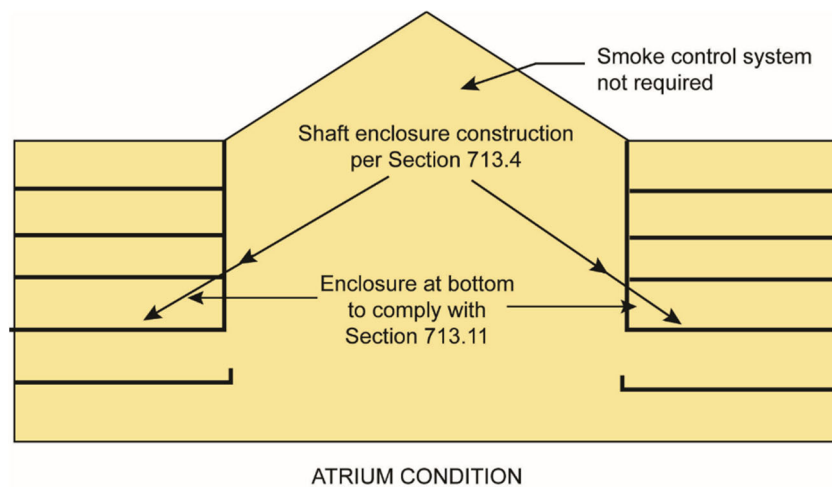

404.6 Horizontal Assemblies in Atriums

Horizontal assembly separation of the atrium from adjacent spaces is no longer required at those openings created for complying escalators and/or exit access stairways.

- Horizontal assembly at atrium may be interrupted by complying openings for escalators and exit access stairways
- Allows for vertical penetration of atrium boundary where:
 - Opening protected by closely spaced sprinklers and a draft curtain, and
 - Area of opening does not exceed twice the horizontal projected area of the escalator, and
 - Openings do not connect more than four stories, except in Group B and M occupancies
- Recognizes that complying floor openings are permitted in a horizontal assembly that isolates atrium from other stories in the building.

In the evaluation of whether a smoke control system is required for an atrium condition, vertical opening protection consisting of a combination of both the atrium and a shaft enclosure is now recognized.

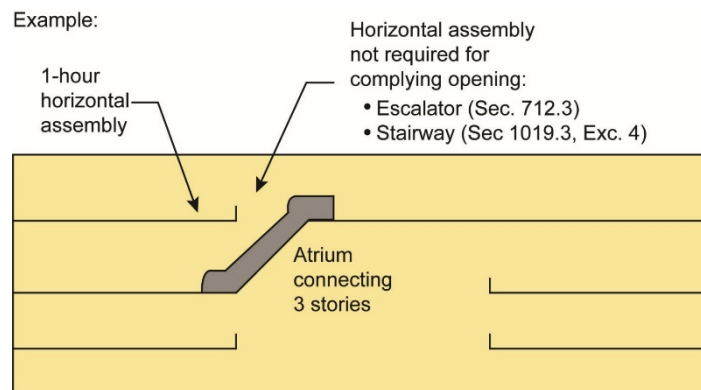

406.2.4 Floor Surfaces in Parking Garages

The mandate for a sloping floor in the vehicle areas of parking garages has been reinstated in the VCC for those garages classified as Group S-2 occupancies.

- Floor in vehicle areas of Group S-2 parking garages now required to be sloped.
 - Previous allowance for no slope considered helpful in design of large garages constructed of prefabricated materials.
- Applicable to both open and enclosed garages.
- Allows for means to move damaging oils and deicing salts from floor surface to approved areas.

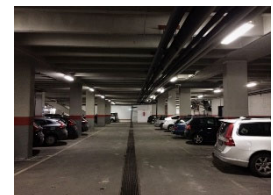

407.3.1.1 Group I-2 Corridor Doors (New)

Several specific conditions related to corridor doors have expanded the smoke-resistant criteria in order to address the various types of doors used in corridors of Group I-2 care facilities.

- Expanded corridor door criteria to address Group I-2 conditions:
 - Solid doors to have:
 - Close-fitting operational tolerances
 - Head and jamb stops
 - Dutch-style doors to have:
 - Astragal, rabbet or bevel at meeting edges of upper and lower door sections
 - Latching hardware at both upper and lower door sections
 - Hardware that connects upper and lower sections to function as a single leaf
- New provisions align with Centers for Medicare & Medicaid Services federal standard.
- Where the corridor is used as a source of makeup air for exhaust systems in adjacent rooms, doors permitted to have:
 - Louvers, or
 - A clearance of no more than $2/3$ inch between the bottom of the door and the floor surface

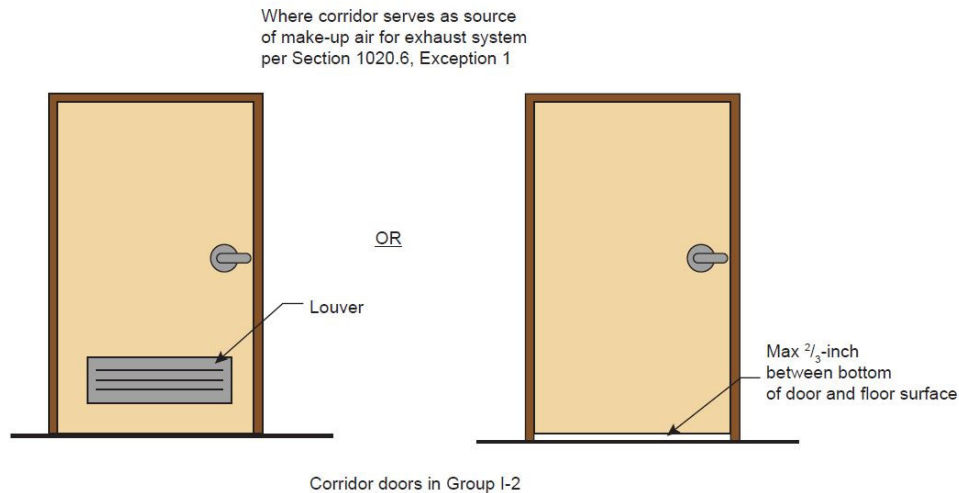

407.4 Means of Egress

The 2018 VCC refers to Section 1002.2 for fire safety evacuation plans. However, that section is deleted by VA as fire safety evacuation plans are covered under the SFPC. The proposal fixes the broken link to section 1002.2 of the VCC and deletes the reference to the IFC as the components necessary to support a defend-in-place emergency response are addressed in Section 404 of the SFPC.

- Section clarified to reflect VA's deletion of 1002.2 for evacuation plans

407.4.4.1, 407.4.4.3 Group I-2 Care Suites

Egress travel allowances, both within an individual care suite as well as from a suite into a corridor, have been revised to allow for additional design flexibility and consistency with the CMS federal standard.

- Revised egress travel allowances to add design flexibility and consistency with the CMS federal standard
- The number of intervening rooms encountered along the egress path is no longer limited, as only the 100-ft travel distance to a corridor or horizontal exit will apply.
 - Exception permitting increase to 125 ft for automatic smoke detection in care suite has been deleted.



407.6.1 Automatic Closing Doors in Group I-2 (New)

In Group I-2 occupancies, the closing of automatic-closing doors on hold-open devices must now also occur upon activation of the fire alarm system or automatic sprinkler system.

- The closing of such doors on hold-open devices must now also occur upon activation of fire alarm system or sprinkler system.
 - Activation continues to also be required upon actuation of smoke detectors or loss of power to the hold-open device or smoke detector.
- All such doors with hold-open devices located in the same smoke compartment are to release upon the automatic release of the hold-open device on any one of such doors.
- Requirements applicable to locations where automatic-closing doors are required by VCC, as well as where such doors are not required but are provided as a design decision.
- Automatic-closing required in two situations:
 - Pair of opposite-swinging doors in smoke barrier wall across a corridor, and
 - Special-purpose horizontal sliding, accordion or folding doors installed in a smoke barrier
- New provisions align with CMS federal standard



411.5 Puzzle Rooms (New)

A new type of building use, the puzzle room, is now regulated in a manner consistent with traditional special amusement areas. In addition, special means of egress requirements have been established that are specific only to such puzzle rooms.

- Now regulated as special amusement areas; must comply with all fire- and life-safety provisions of Section 411
- Special exiting requirements added to solely address puzzle rooms:
 - Per Ch. 10, or
 - Alternate design approved by BO, or
 - Exit to be open and readily available upon activation by fire alarm system, sprinkler system, or manual control at constantly attended location
- Puzzle rooms, as well as all other special amusement areas, must also meet the following criteria:
 - Classified as Group A or B occupancy, based upon occupant load.
 - Fire protection systems required, including:
 - Automatic sprinkler system
 - Automatic smoke detection system
 - Emergency voice/alarm communication system
 - Special exit marking, including approved directional marking.
 - Class A interior finishes.



413 Combustible Storage

There is a change to IFC Table 3203.8 that is relevant to VCC 413 Combustible Storage. Note there is no change to 413 itself. The IFC table now considers high-piled storage of lithium-ion batteries to be high-hazard.

- Combustible storage to comply with VCC 413 (no change)
- High-piled storage of lithium-ion batteries is now considered high-hazard due to change to IFC Table 3203.8 High-Piled Storage of Lithium-Ion Batteries



[F] 414.2.3 Fire Wall Use for Control Areas

The scoping limitations of a fire wall's use to create separate buildings have been expanded through a new allowance for the number of control areas permitted.

- For purposes of determining the number of control areas in a building, each portion separated by one or more fire walls shall be considered a separate building.
 - Previously, the “separate building” allowance has been limited to allowable area, allowable height and type of construction
- New allowance permits additional quantities of hazardous materials without classification as a Group H occupancy by increasing the number of control areas permitted in the structure.

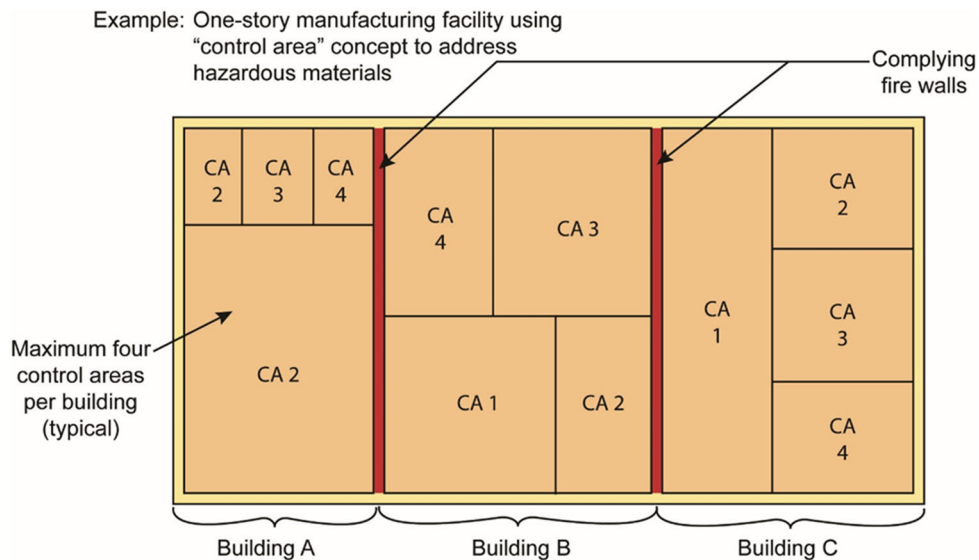

[F] Table 414.2.5(1) Toxic Solids in Retail Occupancies

The maximum allowable quantity of solid toxic material can be increased in retail and storage facilities if the toxic classification is based solely on the LC₅₀.

- MAQ for solid toxic materials increased to 10,000 lbs IF:
 - Toxic is the only hazard classification for the material, and
 - Product is in original sealed containers, and
 - Toxic classification is based solely on LC₅₀

416.4 Spray Booths

There is a change to IFC 2404.3.3.6 that is relevant to VCC 416.4. Note there is no change to 416.4 itself. The IFC no longer restricts spray booths to a maximum size of 1,500 ft².



- No change to VCC 416.4
- Spray booths required to be designed, constructed and operated in accordance with the IFC.
- No longer limited to 1,500 ft² maximum per IFC 2404.3.3.6

422.7 Cooking in Ambulatory Care Facilities (New)

Where domestic cooking facilities are provided in ambulatory care facilities, conditions addressing the installation of the cooking appliances have now been established to address any fire concerns.

- Five fundamental conditions of compliance must be met to allow the installation of domestic cooking appliances.

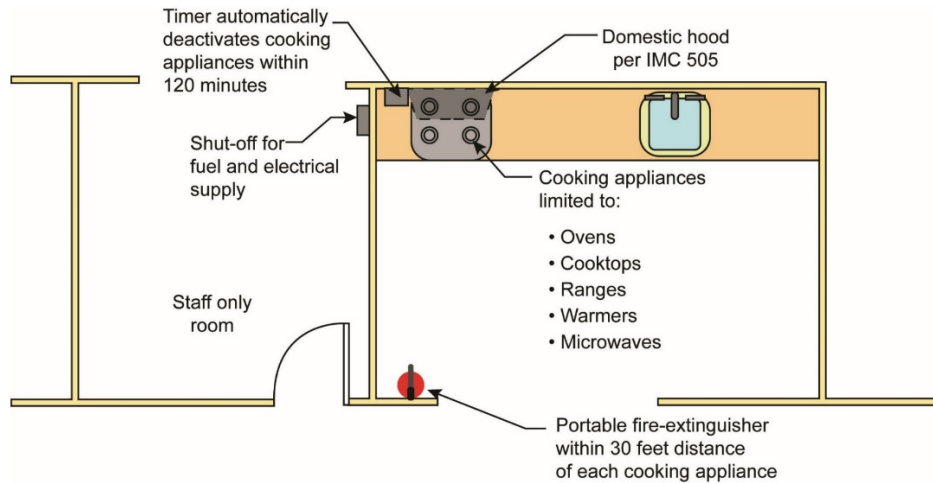

424 Play Structures

The interior finish materials of play structures are now regulated for flame spread purposes. In addition, the scoping provisions have been modified to include larger structures, and the requirements are no longer limited to play structures for children's use.

- No longer limited to structures used solely by children
- New requirements for structures over 600 ft² in area or over 10 ft in height:
 - Interior finishes per Table 803.13
 - Designed per Chapter 16
- Special investigation to demonstrate adequate fire safety now required where area of play structure exceeds 600 ft² in area
 - Threshold increased from 300 ft² in area

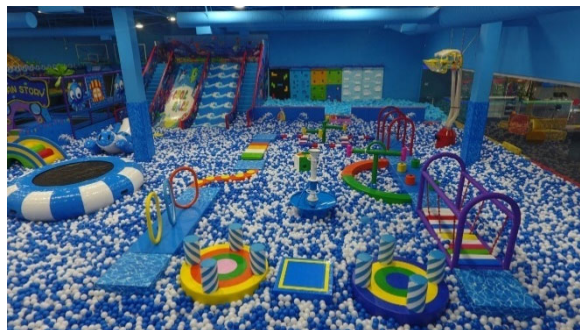

426 Combustible Dust, Grain Processing, and Storage

There is a change to IFC Chapter 22 that is relevant to VCC 426 Combustible Dust, Grain Processing, and Storage. Note there is no change to 426 itself. IFC Chapter 22 is revised to include criteria for mitigating the accumulation of combustible dust and control of ignition sources.

- Buildings that store or handle combustible dusts required to comply with the IFC
- IFC Ch 22 Combustible Dust-Producing Operations revised to include criteria for mitigating the accumulation of dust and control ignition sources
 - Explosion prevention
 - Dust collection
 - Control of ignition sources
 - Housekeeping
 - Emergency response plan
 - Employee training



432 Plant Processing or Extraction Facilities



During recent code development cycles, construction requirements have been added to the International Fire Code without a direct link from the International Building Code. This proposal provides the connection between the Virginia Construction Code and the International Fire Code for Plant Processing or Extraction Facilities (IFC Chapter 39).

- New section references IFC Chap 39 for construction of such facilities of any occupancy group
- Systems or equipment used for the extraction of oils from plant material required to be:
 - Listed and labeled in accordance with UL1389, or
 - Approved for the specific use based on an analysis and report by an RDP



433 Electrical Energy Storage Systems (ESS)



- Such systems shall comply with the applicable provisions of the IFC.



503.1.4 Occupied Roof Allowances

The proper approach to dealing with occupied roofs from the perspectives of building height, number of stories and installation of occupant notification features has been further clarified for a more consistent application of the code's intent.

- Clarifies an occupied roof is not included in building height or number of stories.
 - Any roof structures to comply with 1511 for penthouses and other enclosed rooftop structures.
- Occupant notification to be provided at the roof level where alarm system is required elsewhere in the building.
- Such notification applicable to:
 - Audible alarms
 - Emergency voice/alarm communication systems
 - Visual alarms



Table 504.4 Allowable Height in Stories

In addition to establishing height limits in stories above grade plane for mass timber construction, which were already incorporated into the 2018 VCC, the allowable height for Group S-1 occupancies in sprinklered buildings of Type IIB and IIIB construction and S-2 buildings of Type IV-HT construction have been increased.

- Limits modified for S-1 and S-2
- Height limits for S-1 occupancies in fully-sprinklered buildings of Type IIB and IIIB construction are increased to 4 stories from 3.
 - Restores story limits of 2006 IBC that were part of numerous reductions due to inconsistencies in original thresholds.
- S-2 story limits for Type IV-HT buildings have been increased to six stories if sprinklered, and five stories if not
 - Corrects two tabular errors that went undetected in transition from Table 503 in 2012 IBC to Table 504.4 in 2015 edition.

TABLE 504.4 Allowable Number of Stories Above Grade Plane^{a,b}

Occupancy Classification	See Footnotes	Type of Construction											
		Type I		Type II		Type III		Type IV		Type IV	Type IV	Type V	
		A	B	A	B	A	B	A	B	C	HT	A	B
A-1	NS	UL	5	3	2	3	2	<u>3</u>	<u>3</u>	<u>3</u>	3	2	1
	S	UL	6	4	3	4	3	<u>9</u>	<u>6</u>	<u>4</u>	4	3	2
A-2	NS	UL	11	3	2	3	2	<u>3</u>	<u>3</u>	<u>3</u>	3	2	1
	S	UL	12	4	3	4	3	<u>18</u>	<u>12</u>	<u>6</u>	4	3	2
A-3	NS	UL	11	3	2	3	2	<u>3</u>	<u>3</u>	<u>3</u>	3	2	1
	S	UL	12	4	3	4	3	<u>18</u>	<u>12</u>	<u>6</u>	4	3	2
S-1	NS	UL	11	4	2	3	2	<u>4</u>	<u>4</u>	<u>4</u>	4	3	1
	S	UL	12	5	3	4	3	<u>10</u>	<u>7</u>	<u>5</u>	5	4	2
S-2	NS	UL	11	5	3	4	3	<u>4</u>	<u>4</u>	<u>4</u>	<u>45</u>	4	2
	S	UL	12	6	4	5	4	<u>12</u>	<u>8</u>	<u>5</u>	<u>56</u>	5	3

(partial table)

Table 506.2 Allowable Building Area

In addition to establishing building area limitation for mass timber construction, which was already incorporated into the 2018 VCC, an increase has occurred in the allowable single-story floor area for Group I-3 occupancies in sprinklered buildings of Type IIA construction.

- Allowable area factor modified for I-3 occupancies in one-story buildings of Type IIA
 - 45,000 ft² limit has been increased to 60,000 ft² for single-story fully-sprinklered buildings
 - Corrects tabular error that went undetected in transition from Table 503 in 2012 IBC to Table 504.4 in 2015 edition

TABLE 506.2 Allowable Area Factor (A_t = NS, S1, S13R, S13D or SM, as Applicable) in Square Feet^{a,b}

Occupancy Classification	See Footnotes	Type of Construction											
		Type I		Type II		Type III		Type IV			Type V		
		A	B	A	B	A	B	A	B	C	HT	A	B
A-1	NS	UL	UL	15,500	8,500	14,000	8,500	<u>45,000</u>	<u>30,000</u>	<u>18,750</u>	15,000	11,500	5,500
	S1	UL	UL	62,000	34,000	56,000	34,000	<u>180,000</u>	<u>120,000</u>	<u>75,000</u>	60,000	46,000	22,000
	SM	UL	UL	46,500	25,500	42,000	25,500	<u>135,000</u>	<u>90,000</u>	<u>56,250</u>	45,000	34,500	16,500
A-2	NS	UL	UL	15,500	9,500	14,000	9,500	<u>45,000</u>	<u>30,000</u>	<u>18,750</u>	15,000	11,500	6,000
	S1	UL	UL	62,000	38,000	56,000	38,000	<u>180,000</u>	<u>120,000</u>	<u>75,000</u>	60,000	46,000	24,000
	SM	UL	UL	46,500	28,500	42,000	28,500	<u>135,000</u>	<u>90,000</u>	<u>56,250</u>	45,000	34,500	18,000
A-3	NS	UL	UL	15,500	9,500	14,000	9,500	<u>45,000</u>	<u>30,000</u>	<u>18,750</u>	15,000	11,500	6,000
	S1	UL	UL	62,000	38,000	56,000	38,000	<u>180,000</u>	<u>120,000</u>	<u>75,000</u>	60,000	46,000	24,000
	SM	UL	UL	46,500	28,500	42,000	28,500	<u>135,000</u>	<u>90,000</u>	<u>56,250</u>	45,000	34,500	18,000
I-3	NS ^{d,e}	UL	UL	15,000	10,000	10,500	7,500	<u>36,000</u>	<u>24,000</u>	<u>12,000</u>	12,000	7,500	5,000
	S1	UL	UL	<u>60,000</u>	40,000	42,000	30,000	<u>144,000</u>	<u>96,000</u>	<u>48,000</u>	48,000	30,000	20,000
	SM	UL	UL	45,000	30,000	31,500	22,500	<u>108,000</u>	<u>72,000</u>	<u>36,000</u>	36,000	22,500	15,000

(partial table)

506.3.2 Allowable Area Frontage Increase

The methodology for establishing the permissible allowable area increase for frontage has been simplified through the use of a tabular format to make for a more efficient approach to allowable area determination.

- Methodology for determining allowable area increase for open frontage has been simplified through use of a tabular format.
 - Allowance for weighting the open space area increase has been eliminated
- Table 506.3.3 based on two criteria:
 - Smallest public way or open space that ≥ 20 ft, and
 - Percentage of building perimeter having ≥ 20 ft of public way and/or open space
- Resulting frontage increase intended to be consistent with increase determined by previous method
 - Greater frontage increases occur to some degree
 - In some cases, greater increase may be obtained by designer if one or more open spaces not recognized

TABLE 506.3.3 Frontage Increase Factor^a

Percentage of Building Perimeter	Open Space			
	0 to less than 20 Feet	20 to less than 25 Feet	25 to less than 30 Feet	30 Feet or greater
0 to less than 25	0	0	0	0
25 to less than 50	0	0.17	0.21	0.25
50 to less than 75	0	0.33	0.42	0.50
75 to 100	0	0.50	0.63	0.75

a. Interpolation is permitted.

TABLE 506.3.3.1 Section 507 Buildings^a

Percentage of Building Perimeter	Open Space					
	30 to less than 35 feet	35 to less than 40 feet	40 to less than 45 feet	45 to less than 50 feet	50 to less than 55 feet	55 to less than 60 feet
0 to less than 25	0	0	0	0	0	0
25 to less than 50	0.29	0.33	0.38	0.42	0.46	0.50
50 to less than 75	0.58	0.67	0.75	0.83	0.92	1.00
75 to 100	0.88	1.00	1.13	1.25	1.38	1.50

a. Interpolation is permitted.

506.3.2 Allowable Area Frontage Increase Example

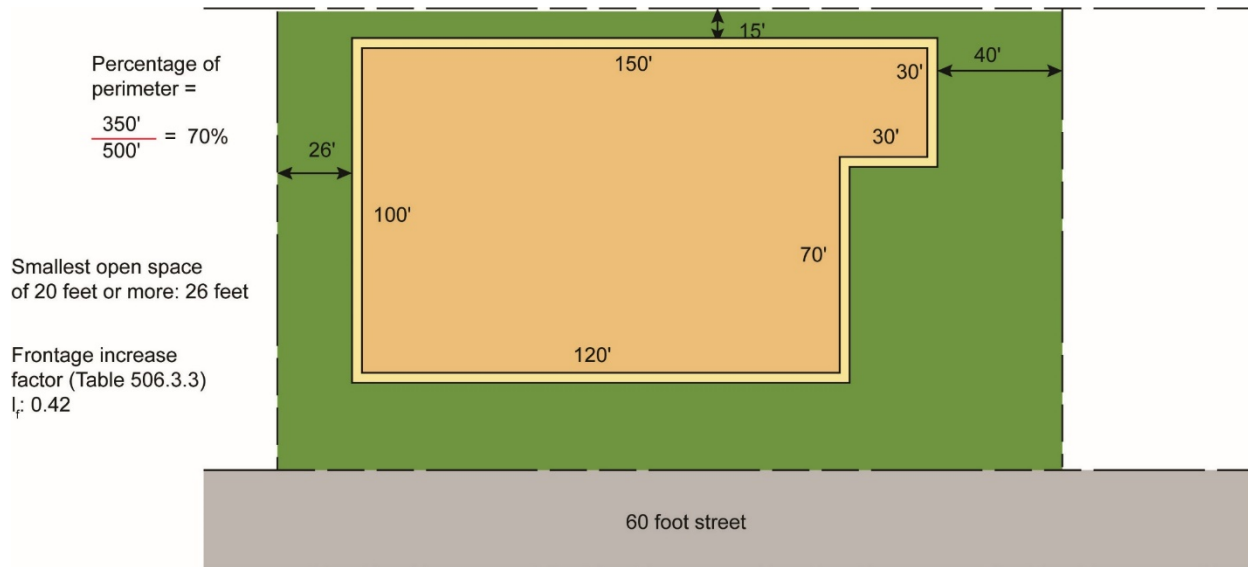

Note: If west open space is ignored, I_f would be 0.50 based on 50% of perimeter open with smallest open space of > 30 feet

508.4.4, Table 508.4 Separated Occupancies

The clarity and functionality provided by a format change to Table 508.4.4 addressing separated occupancies is intended to eliminate any confusion as to the table's proper use.

- Table reformatted for clarity; no change in technical requirements
- All cells of Table 508.4 now contain the minimum required fire-resistance-rated occupancy separation to be applied when the separated occupancies method is applied

TABLE 508.4 Required Separation of Occupancies (Hours)^f

Occupancy	A, E		I-1 ^a , I-3, I-4		I-2		R ^a		F-2, S-2 ^b , U		B ^e , F-1, M, S-1		H-1		H-2		H-3, H-4		H-5	
	S	NS	S	NS	S	NS	S	NS	S	NS	S	NS	S	NS	S	NS	S	NS	S	NS
A, E	N	N	1	2	2	NP	1	2	N	1	1	2	NP	NP	3	4	2	3	2	NP
I-1 ^a , I-3, I-4	<u>1</u>	<u>2</u>	N	N	2	NP	1	NP	1	2	1	2	NP	NP	3	NP	2	NP	2	NP
I-2	<u>2</u>	<u>NP</u>	<u>2</u>	<u>NP</u>	N	N	2	NP	2	NP	2	NP	NP	NP	3	NP	2	NP	2	NP
R ^a	<u>1</u>	<u>2</u>	<u>1</u>	<u>NP</u>	<u>2</u>	<u>NP</u>	N	N	1 ^c	2 ^c	1	2	NP	NP	3	NP	2	NP	2	NP
F-2, S-2 ^b , U	<u>N</u>	<u>1</u>	<u>1</u>	<u>2</u>	<u>2</u>	<u>NP</u>	<u>1^c</u>	<u>2^c</u>	N	N	1	2	NP	NP	3	4	2	3	2	NP
B ^e , F-1, M, S-1	<u>1</u>	<u>2</u>	<u>1</u>	<u>2</u>	<u>2</u>	<u>NP</u>	<u>1</u>	<u>2</u>	<u>1</u>	<u>2</u>	N	N	NP	NP	2	3	1	2	1	NP
H-1	<u>NP</u>	<u>NP</u>	<u>NP</u>	<u>NP</u>	<u>NP</u>	<u>NP</u>	<u>NP</u>	<u>NP</u>	<u>NP</u>	<u>NP</u>	<u>NP</u>	<u>NP</u>	N	NP	NP	NP	NP	NP	NP	NP
H-2	<u>3</u>	<u>4</u>	<u>3</u>	<u>NP</u>	<u>3</u>	<u>NP</u>	<u>3</u>	<u>NP</u>	<u>3</u>	<u>4</u>	<u>2</u>	<u>3</u>	<u>NP</u>	<u>NP</u>	N	NP	1	NP	1	NP
H-3, H-4	<u>2</u>	<u>3</u>	<u>2</u>	<u>NP</u>	<u>2</u>	<u>NP</u>	<u>2</u>	<u>NP</u>	<u>2</u>	<u>3</u>	<u>1</u>	<u>2</u>	<u>NP</u>	<u>NP</u>	<u>1</u>	<u>NP</u>	1 ^d	NP	1	NP
H-5	<u>2</u>	<u>NP</u>	<u>2</u>	<u>NP</u>	<u>2</u>	<u>NP</u>	<u>2</u>	<u>NP</u>	<u>2</u>	<u>NP</u>	<u>1</u>	<u>NP</u>	<u>NP</u>	<u>NP</u>	<u>1</u>	<u>NP</u>	<u>1</u>	<u>NP</u>	N	NP



508.5 through 508.5.11 Live/Work Units

The criteria for live/work units has been relocated from the special use provisions of Chapter 4 to the mixed occupancy provisions of Section 508, with no change to the technical requirements.

- Formerly 419.1 - 419.9
- No technical changes
- Live/work use continues to not create a mixed occupancy condition.
- Provision should be considered as an exception to mixed occupancy

Table 509.1 Storage Battery Systems as Incidental Uses

The identification of stationary storage battery systems as incidental uses, and the corresponding fire separations required for such uses, have been deleted from Table 509.1 and are now more comprehensively regulated by Section 1207 of the IFC.

- Stationary storage battery systems as incidental use have been deleted from Table 509.1.
- Fire separations, as well as other protection features, are now extensively addressed in IFC Section 1207, Electrical Energy Storage Systems 



TABLE 509.1 Incidental Uses

Room or Area	Separation and/or Protection
Stationary storage battery systems having an energy capacity greater than the threshold quantity specified in Table 1206.2 of the <i>International Fire Code</i>	1 hour in Group B, F, M, S and U occupancies; 2 hours in Group A, E, I and R occupancies.

510.2 Stairway Construction in Podium Buildings

Where a combustibile building (Type III, IV or V) is located above the lower noncombustible (Type IA) building when applying the horizontal building separation allowance, interior exit stairways located within the Type IA building may be constructed of combustible materials where specified conditions are met.

- Stairway construction in IA (lower) portion of podium buildings now permitted to be of combustible materials where two conditions exist:
 - Upper building is of Type III, IV or V, and
 - Stairway in lower building enclosed by minimum 3-hour fire-resistance-rated construction (shaft enclosure) with protected openings.
- Addresses confusion on how to address stairway construction that connects combustible and noncombustible portions of a podium building.
 - 1011.7 indicates stairways to be built of materials permitted based on building's type of construction.
- Stairway is conceptually located totally within upper Type III, IV or V building, thus allowing for combustible stairway construction.

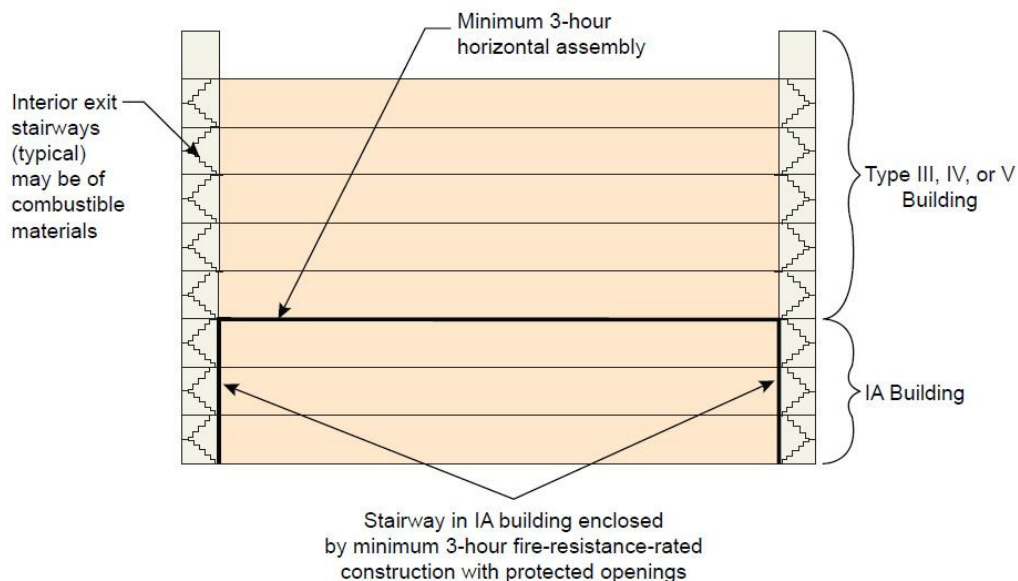

603.1 Combustible Materials in Types I and II

In buildings of Type I and II construction, the allowance for the use of fire-retardant-treated wood in shaft enclosure and roof construction has been modified for Group I-2 buildings. In addition, the use of wood nailers for parapet flashing and roof cants is permitted in all buildings.

- Adds or modifies several applications for the use of combustible materials in Types I and II buildings
- FRT wood no longer permitted for nonbearing partitions where used in shaft enclosures within I-2 and ambulatory care facilities.
- I-2 roof construction containing FRT wood now required to be:
 - Covered by not less than Class A roof covering or roof assembly, and
 - Roof assembly to have fire-resistance rating where required by type of construction
- Wood nailers are now permitted for parapets and roof cants.

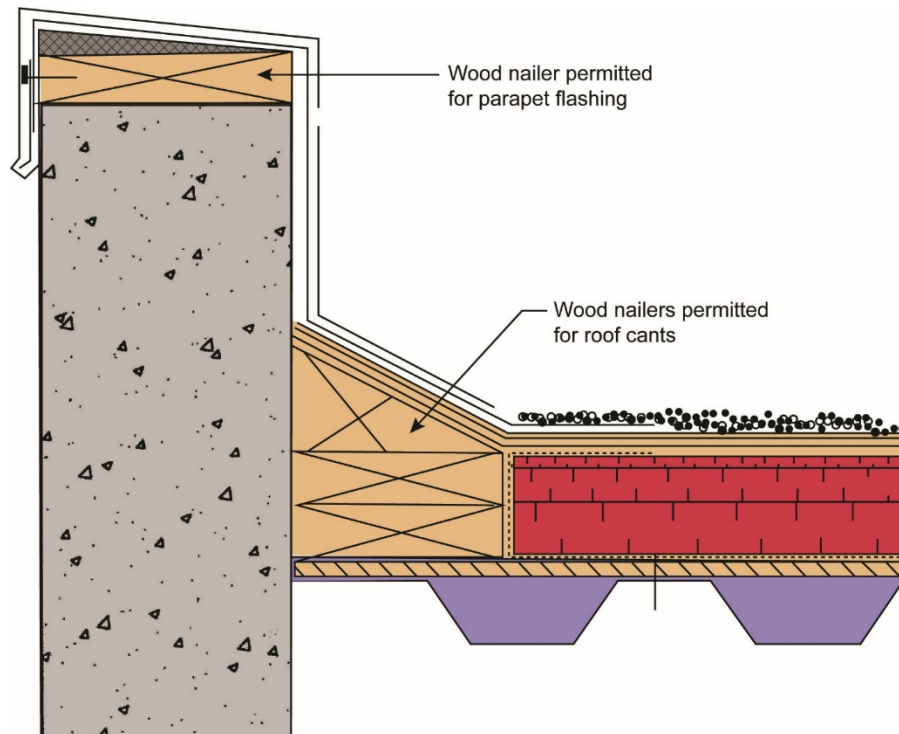

704.6.1 Secondary Attachments and Fireproofing (New)

Guidance has been provided to ensure continuity of fire-resistive protection where secondary steel attaches to either primary or secondary fire-resistance-rated structural members.

- Where primary and secondary structural steel members require fire protection, secondary steel attachments to have same protective material and thickness as required for primary member to address heat transfer.
- Protection to extend away from primary member:
 - At least 12 inches, or
 - Applied to entire length where attachment < 12 inches in length.
- Where attachment is hollow and ends are open, fire-resistive material and thickness to be applied to both the interior and exterior of the hollow steel attachment.

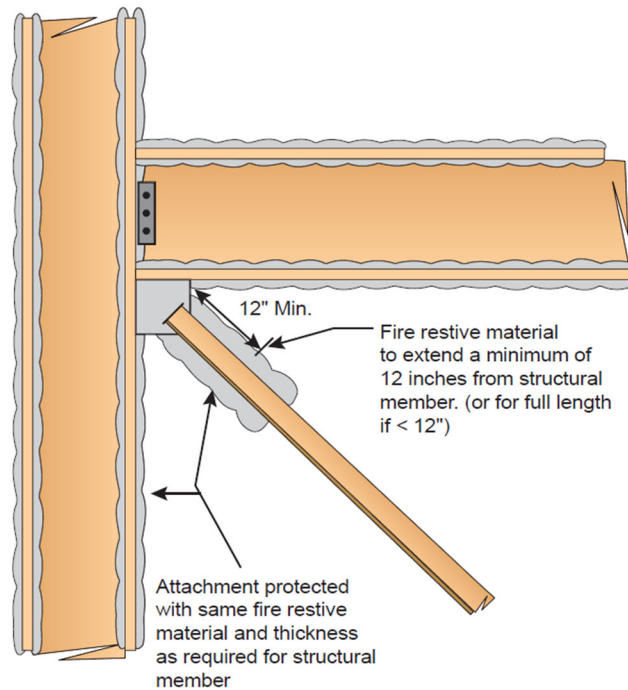

Table 705.5 Exterior Wall Rating

The previous Table 602 dealing with exterior wall fire-resistance ratings based on fire separation distance has been relocated to Section 705 for inclusion with the general exterior wall requirements. The table was also revised to include the new mass timber construction types.

- Formerly Table 602
- Entries have been made for new construction types IV-A, IV-B and IV-C.

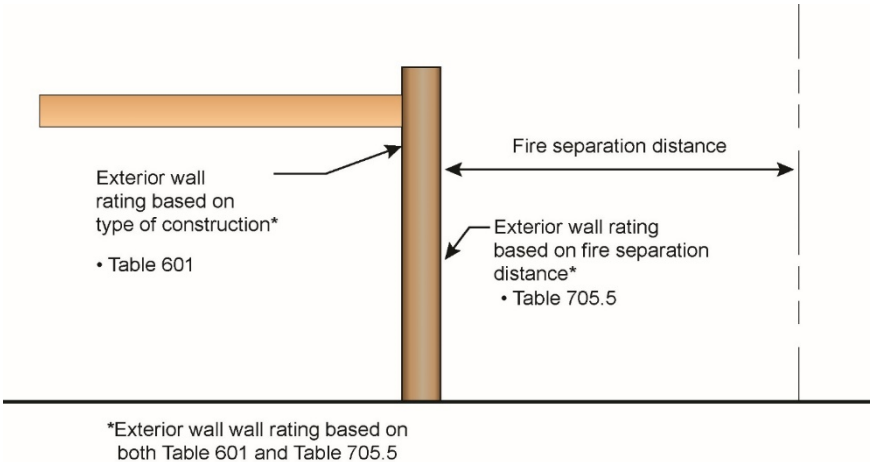

TABLE 602 705.5 Fire-Resistance Rating Requirements for Exterior Walls Based on Fire Separation Distance^{a,d,g}

Fire Separation Distance = X (feet)	Type Of Construction	Occupancy Group H ^o	Occupancy Group F-1, M, S-1 ^f	Occupancy Group A, B, E, F-2, I, R ^l , S-2, U ^h
X < 5 ^b	All	3	2	1
5 ≤ X < 10	IA, IV-A	3	2	1
	Others	2	1	1
10 ≤ X < 30	IA, IB, IV-A, IV-B	2	1	1 ^c
	IIB, VB	1	0	0
	Others	1	1	1 ^c
X ≥ 30	All	0	0	0

For SI: 1 foot = 304.8 mm.

Fire Walls - 706.1 General

- Returns language that a firewall creates a separate building for application of Chapter 9
- Equipment and systems may serve multiple attached buildings on the same lot



706.1.1 Party Walls



- Exception 2 deleted
- Party walls and fire walls are now required on lot lines dividing buildings for ownership purposes



707.4, 716 Separations of Energy Storage Systems

To both adequately isolate and protect energy storage systems from potential thermal runaway, the use of glazing with only a fire-protection rating is prohibited in fire-resistance-rated walls that are a portion of the enclosure of energy storage systems.

- Where fire barriers enclose energy storage systems, fire-protection-rated glazing not permitted in:
 - Fire door frames with transom lights and sidelights, and
 - Fire window assemblies.
- Where glazing is provided, it must be fire-resistance-rated.
- Helps address concern of thermal runaway through resistance to heat flow through the glazing.
- Enclosure requirements established in Table 1207.1 of the IFC, with a minimum required separation of 2-hour fire barriers.

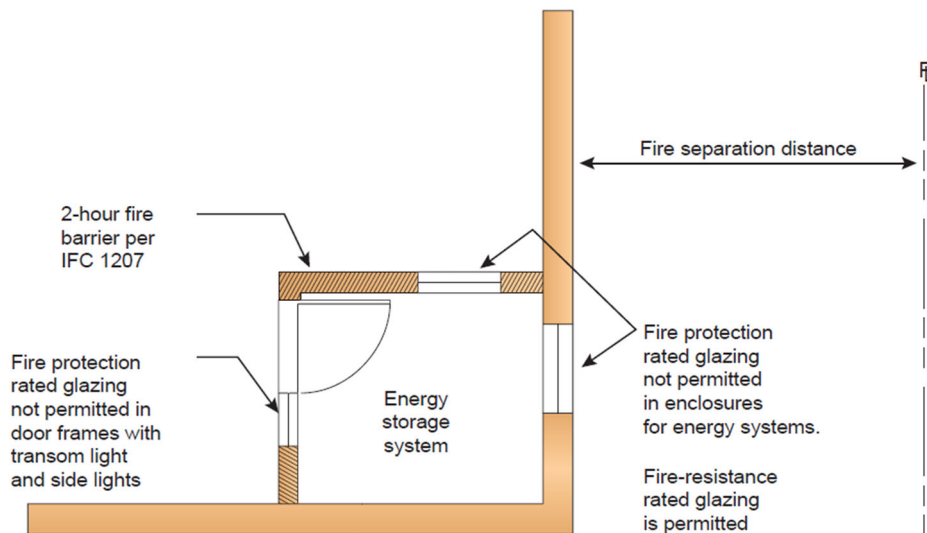

707.5 Enclosure of Exit Passageways

Although the code text in the exception only mentions terminating at the 'roof' sheathing, slab or deck, and it does not specifically mention 'floor' above, it is our opinion that the exception should be applicable to both 'floor and roof' systems.

- Allowance now provided for fire barriers creating an exit passageway to terminate at a fire-resistance-rated lid
 - Enclosure at top to have same fire-resistance rating as required for the exit passageway.
- This new option can be applied where the fire barrier does not extend to the underside of the floor or roof sheathing, slab or deck above.
- Permits passage of ducts, piping and conduit from one side of the exit passageway to the other without need for a horizontal shaft enclosure.
- Provision is applicable where either a floor or roof occurs above the exit passageway enclosure.

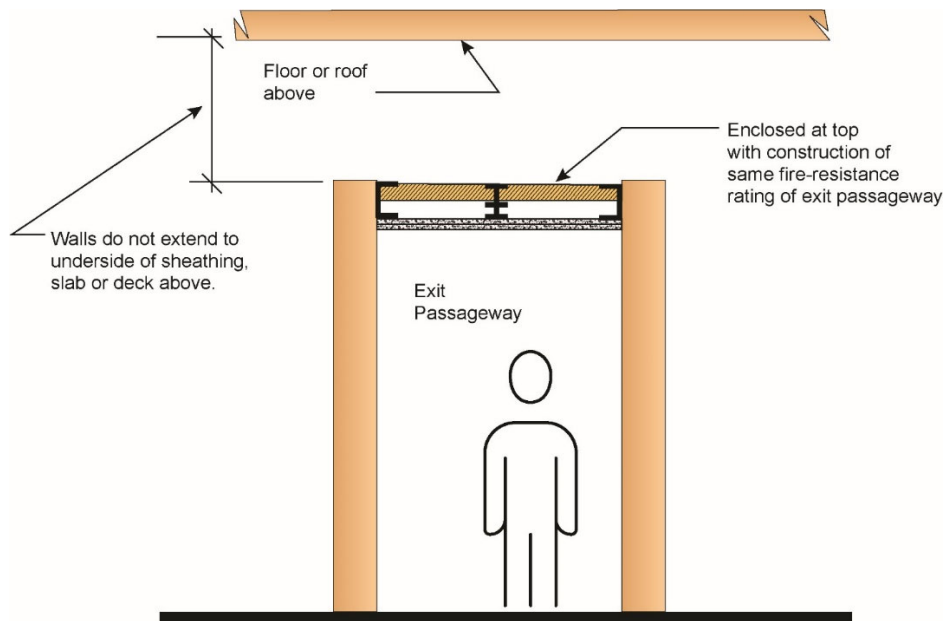

708.1, 708.4.1 Supporting Construction for Fire Partitions

A more complete list of wall assemblies required to be constructed as fire partitions has been provided, and additional locations have been identified where fire partitions are permitted to be supported by non-rated construction.

- Additional locations have been identified where fire partitions need not be supported by equivalent fire-resistance-rated construction.
- Separation of ambulatory care facilities from adjacent spaces
- Walls separating dwelling and sleeping units in R-1 and R-2 occupancies for purposes of eliminating the manual fire alarm requirement
- Vestibule walls regulated as interior exit discharge
- Allowances continue to be limited to supporting construction in Type IIB, IIIB and VB buildings.

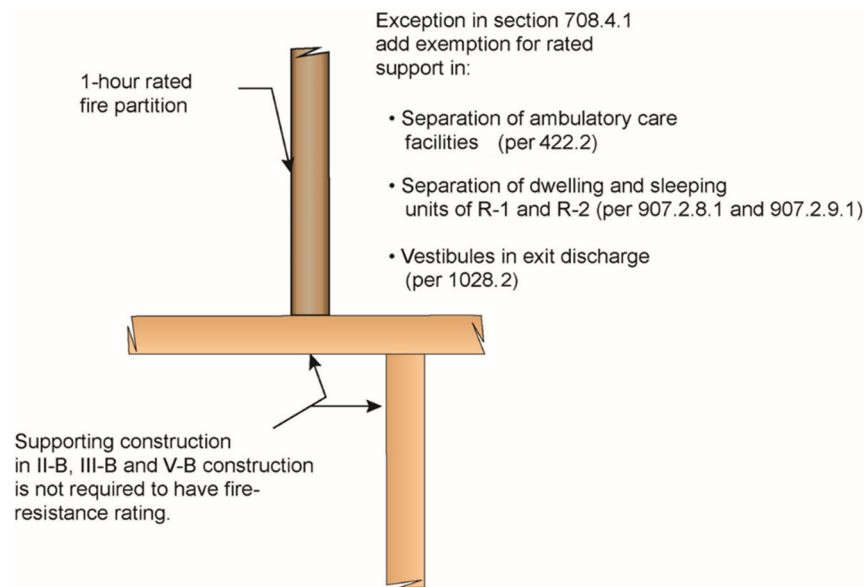

709.4.1 Smoke Barrier Continuity

Smoke barrier and smoke compartment continuity needed to effectively serve their intended purposes have been clarified through revisions to the definition and enclosure provisions.

- The definition of “smoke compartment” and smoke barrier enclosure provisions have been modified to recognize that:
 - Both walls and/or horizontal assemblies can be used to create separate smoke compartments, and
 - Smoke barrier continuity may be accomplished through the extension to an outside wall or to another smoke barrier wall.
- The intent of providing a complete enclosure has now been accomplished.

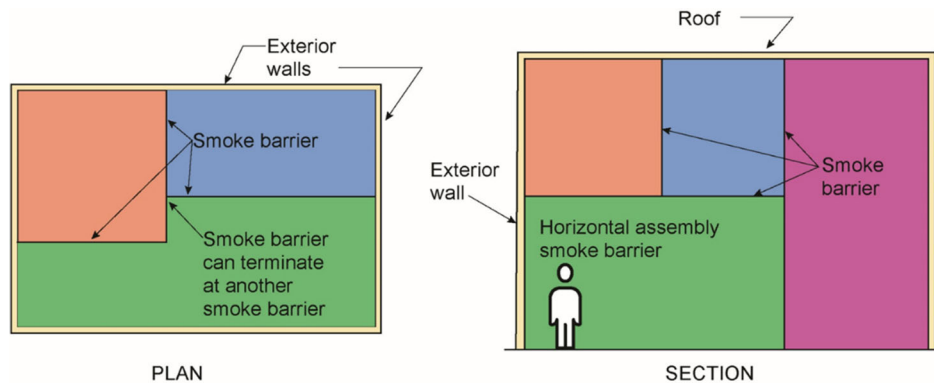

Smoke compartments are created by separating interior areas using smoke barriers that are continuous to:

- Exterior wall or roof
- Another smoke barrier (wall or horizontal assembly)

710.5.2.1, 710.5.3 (New) Smoke Partition Openings

- In Group I-2 hospitals and similar Condition 2 occupancies, pass-through openings are permitted where in compliance with the following four conditions:
 - Smoke compartment does not contain a care suite or sleeping room
 - Openings cannot be installed in fire-rated wall, door or vision panel
 - Top of opening located ≤ 48 in. above floor
 - Aggregate area of all openings within a single room ≤ 80 sqin
- Louvers permitted in smoke partition doors in corridors used for makeup air for exhaust systems in adjacent rooms as set forth in Section 407.3.3.1.
- Allowances are consistent with CMS regulations.



713.12 Top of Shaft Enclosure

- Clarifies section by establishing three specific methods for terminating a shaft enclosure at the top
 - Extend shaft walls to the underside of roof sheathing, deck or slab, or
 - Terminate below the roof assembly with a top enclosure having the same fire-resistance rating as the topmost floor penetrated by the shaft but not less than the required rating of the shaft enclosure, or
 - Extend past the roof assembly and comply with the provisions for rooftop structures in 1511

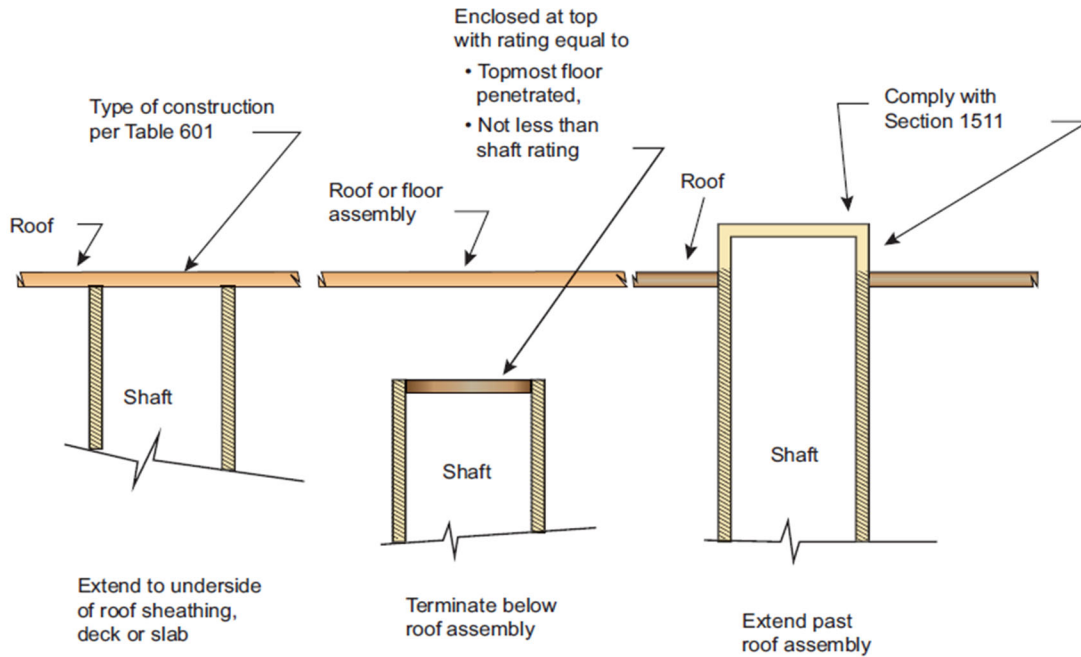

715 Protection of Joints and Voids

- Provisions for joints and voids have been reformatted and modified to allow for more consistent application.
- Joints and voids are required to be “protected” where the protection method is required to be tested to a specific test standard.
- Where a void is only required to be “filled,” there is no specific test standard or listing requirement.

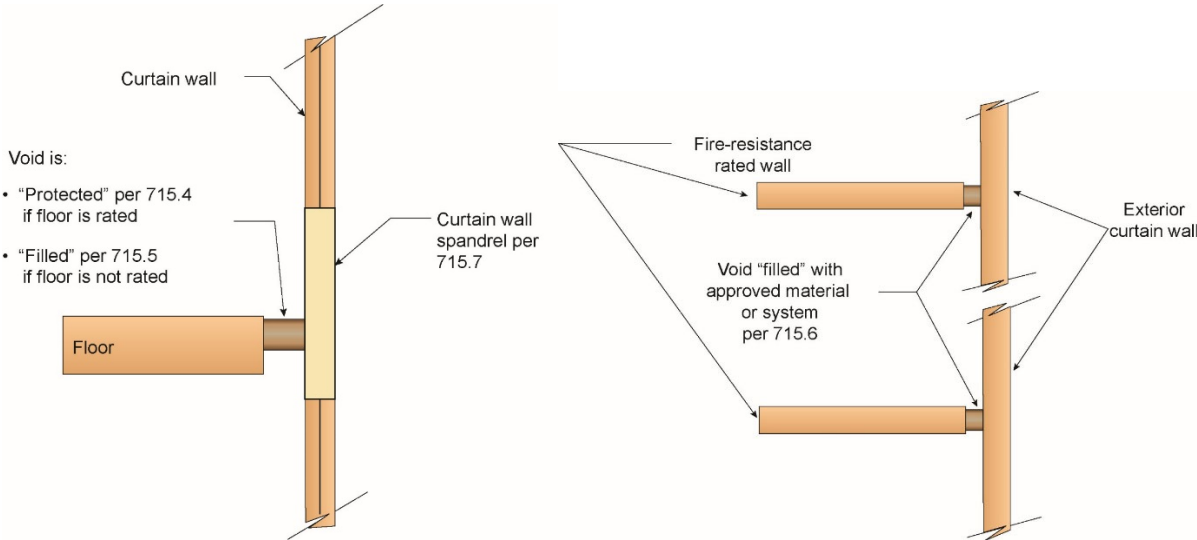

Table 716.1(2) Doors in Double Fire Walls

Appropriate opening protection is now addressed where two doors are used to protect a single opening, such as between adjacent hotel rooms or where a double fire wall is constructed.

- Modified to address required opening protectives where two doors are used to protect a single opening in the two following fire separation walls:
 - Double fire wall is designed and constructed per NFPA 221
 - Fire partition, such as between two adjoining guest rooms.

Diagram illustrating double fire wall construction per NFPA 221, showing two parallel walls with a door opening through both. The door rating is based on each individual wall's rating.

Rating of overall assembly (Hours)	Rating of each individual wall (Hours)	Min. Fire door rating (Hours)
4	3	3
3	2	1 1/2
2	1	1

Door rating based on each individual wall's rating (See separate entry in Table 716.1(2) for single fire walls)



TABLE 716.1(2) Opening Fire Protection Assemblies, Ratings and Markings

Type Of Assembly	Required Wall Assembly Rating (Hours)	Minimum Fire Door And Fire Shutter Assembly Rating (Hours)		Door Vision Panel Size ^a	Fire-Rated Glazing Marking Door Vision Panel ^{b,c}	Minimum Sidelight/ Transom Assembly Rating (Hours)		Fire-Rated Glazing Marking Sidelight/ Transom Panel	
		Fire Protection	Fire Resistance			Fire Protection	Fire Resistance		
Fire walls and fire barriers having a required fire-resistance rating greater than 1 hour	4 3 2 1 1/2								
	<u>Single-wall assembly rating (hours)^a</u>	<u>Each wall of the double-wall assembly (hours)^f</u>							
<u>Double fire walls constructed in accordance with NFPA 221</u>	4	3	3	See note a	<u>D-H-W-180</u>	<u>Not permitted</u>	3	<u>Not permitted</u>	<u>W-180</u>
	3	2	1 1/2	100 sq. in.	<100 sq. in. = <u>D-H-90</u> >100 sq. in. = <u>D-H-W-90</u>	<u>Not permitted</u>	2	<u>Not permitted</u>	<u>W-120</u>
	2	1	1	100 sq. in.	<100 sq. in. = <u>D-H-60</u> >100 sq. in. = <u>D-H-W-60</u>	<u>Not permitted</u>	1	<u>Not permitted</u>	<u>W-60</u>

716.4 Fire-Protective Curtain Assemblies

Labeling and performance requirements for fabric fire-protective curtain assemblies have been established.

- New definition for fire-protective curtain assembly:
 - an assembly consisting of a fabric curtain, bottom bar, guides, coil, and an operating and closing system
- New provisions establish guidance for testing, labeling, and installation
- IBC does not address how or where these systems are to be used or where they would be accepted.
 - It is assumed that the assemblies would typically be installed as a means of smoke and draft control
- Use will need to be reviewed and approved under alternate methods provisions

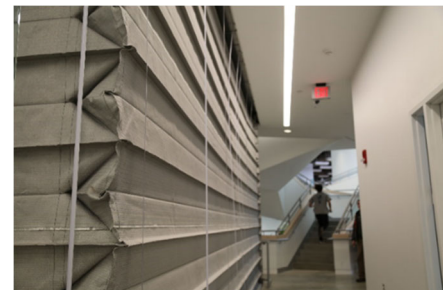

717.2.3 (New), 717.6.2.1 Ceiling Radiation Dampers

An existing Virginia amendment has allowed use of static radiation dampers where equipment was shut down by 3 allowable methods. New requirements added to the IMC provide additional details and options.

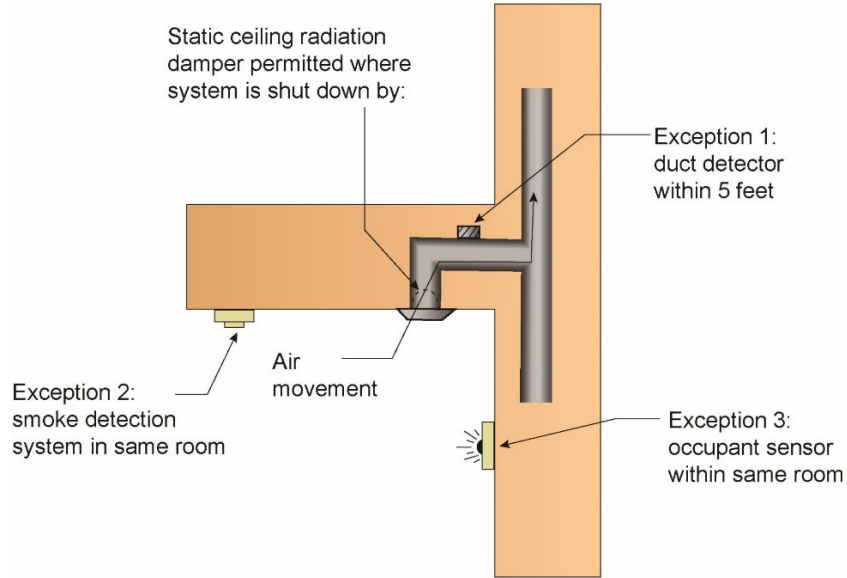

717.4 Access to Dampers

Specific damper access requirements have been established, including an allowance for remote inspection where access cannot be provided.

- Dampers equipped with fusible links and/or internal operators to be provided with a:
 - Min 12 x 12 in. access door, or
 - Removable duct section.
- Previously required “approved” means of access to “permit inspection and maintenance of the damper.”
- Where space constraints or physical barriers restrict damper access for periodic inspection and testing, the damper to be a single- or multi-blade type and comply with remote inspection requirements of NFPA 80 or NFPA 105.
 - Note: Reqmts for maintenance & periodic inspection found in SFPC 706.1



717.5.2 Flex Connectors

An allowance to eliminate fire dampers where a fully ducted HVAC system is provided has been modified to permit the use of flexible connectors.

- Existing Exception 3 allows the omission of fire dampers at penetrations of fire barriers in fully-ducted HVAC systems where specified conditions are met.
- New allowances permit the installation of nonmetal flexible air connectors at two locations:
 - At the duct connection to the air handling unit or equipment located within the mechanical room per VMC 603.9.
 - From an overhead metal duct to a ceiling diffuser within the same room per VMC 603.6.2.



NEC 700.12(B) - General Requirements. (Sources of Power for Emergency Systems), Equipment Design and Location

- This is a notable NEC change that has implications for fire protection.
- Increases the fire-resistance-rating for non-sprinklered spaces (in certain occupancies) where equipment for sources of emergency power are allowed to be installed, from 1 hour to 2 hours.

[F] 806.9 Combustible Lockers as Interior Finish (New)

- Combustible lockers now regulated for interior finish
- Lockers to comply with 803 (Wall and Ceiling Finishes), except:
 - Where constructed entirely of wood and noncombustible materials, lockers are permitted wherever a Class C classification is acceptable.
- Consistent with SFPC requirements



903.2.3 Group E



The occupant load trigger was added to the 2018 model code and was not revised during the 2018 Virginia Code Development process. This addition effectively rendered Virginia's amendment to the area trigger (from 12,000 ft² to 20,000 ft²) meaningless due to the assumed occupant load per square foot.

- Removes occupant load trigger as inconsistent with VA's 20,000 ft² amendment to the area trigger

[F] 903.2.4, 903.2.7, 903.2.9 Upholstered Furniture and Mattresses

The sprinkler provisions for upholstered furniture and mattresses have been modified to clearly indicate the scope of the required protection.

- Sprinkler requirements for Groups F-1 and S-1 where upholstered furniture or mattresses are manufactured, sold or stored have been revised to establish new scope.
 - Group F-1: Area threshold (2,500 ft²) now based on size of fire area where upholstered furniture or mattresses are manufactured
 - Group S-1: Area threshold (2,500 ft²) now based on size of floor area within fire area used for storage of upholstered furniture or mattresses
- In addition, new exception indicates that one-story Group S-1 self-storage facilities are exempt from 2,500 square foot sprinkler threshold where all storage spaces can be accessed directly from exterior.
 - General Group S-1 sprinkler threshold of 12,000 square feet continues to be applicable.



Separation per
Table 707.3.10

Sprinkler system required throughout fire area if:

- F-1; > 2,500 sq. ft. for manufacture,
- S-1; > 2,500 sq. ft. for storage

[F] 903.2.4.2 (New), 903.2.9.3 Distilled Spirits

Imposes a sprinkler requirement for both the manufacturing and bulk storage of distilled spirits.

- Automatic sprinkler protection now required in all:
 - F-1 fire areas used for the manufacture of distilled spirits
 - S-1 fire areas used for the bulk storage of distilled spirits or wine
- Part of a series of changes in IBC and IFC to eliminate confusion in regulation of such buildings.



[F] 903.2.10 Sprinklers in Parking Garages

- Sprinklers now required in S-2 open parking garages where:
 - Any fire area exceeds 48,000 ft², or
 - One or more stories with an occupant load ≥ 30 are located ≥ 55 ft above lowest level of fire department vehicle access
- Sprinkler protection to extend throughout entire garage
- Concern was based on:
 - Increased fuel load due to expanded use of plastics and lightweight materials in vehicles, as well as types of fuels being utilized
 - Recognition of a fire that occurred in a parking garage in Liverpool, England in late 2017



[F] 903.2.10.2 (New) Mechanical-Access Parking Garages

- New definition of mechanical-access enclosed parking garage added with following criteria:
 - Enclosed parking garage
 - Uses parking machines, lifts, elevators and/or other mechanical means
 - Moves vehicles from and to street level
 - Public occupancy prohibited except in vehicle access bay
- Mechanical-access enclosed parking garages now required to be sprinklered regardless of fire area size.
 - Previously only mandated where fire area $> 12,000$ ft²
 - Sprinkler protection required throughout entire building
- New 406.6.4 also requires:
 - Separation from other occupancies by at least 2 hours
 - Fire department access doors at ground level
 - Mechanical smoke removal system
 - Manual emergency shutdown switch
 - Fire control equipment room

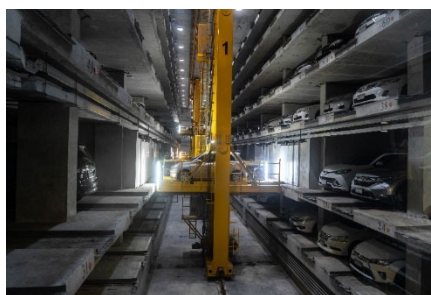

[F] 903.3.1.2 NFPA 13R Sprinkler Protection

The maximum building height where an NFPA 13R sprinkler system is permitted has been reduced. In addition, where the podium provisions of Section 510 are applied, the story height measuring point has been changed to grade plane.

- Scoping for the permitted use of an NFPA 13R sprinkler system in Group R occupancies has been modified such that the following conditions must all be met by the Group R to allow for use of 13R system:
 - Located no more than 4 stories above grade plane, and
 - Floor level of highest story no more than 30 feet above lowest level (or lowest story below highest level) of fire department vehicle access. (previously 60 feet above grade plane)
- In addition, the story limit of four is now to be measured from grade plane in podium buildings (Sec. 510.2 and 510.4) rather than from the horizontal assembly separating the two buildings.

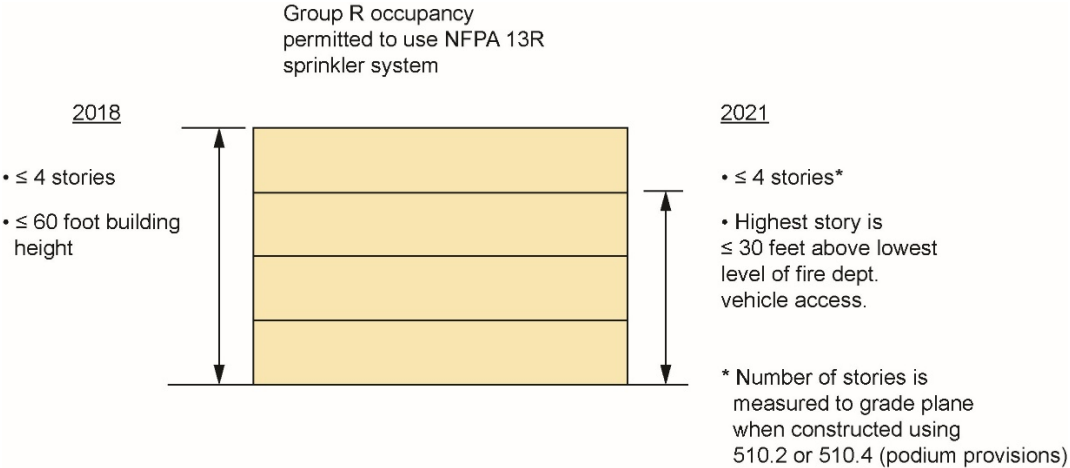

[F] 903.3.1.2.2 Corridor and Balcony Sprinklers

Sprinkler protection must now be extended into corridors and balconies used in the means of egress, even though the location may be exempt based upon the NFPA 13R standard.



- In Group R buildings with NFPA 13R sprinkler system, sprinkler protection shall extend to corridors and balconies in means of egress where any of following conditions apply:
 - Corridors with combustible walls or floors
 - Corridors with interior change of direction > 45°
 - Corridors that are < 50% open to the outside atmosphere at the ends
 - Open-ended corridors and associated exterior stairways per 1027.6, Exception 3
 - Egress balconies not in compliance with 1021.2 (wall separation) and 1021.3 (openness)
- Important to recognize that IBC takes precedence over NFPA 13 where a conflict occurs.
 - Eliminates conflicting opinions in the determination of whether corridors and egress balconies are considered as interior or exterior conditions
- New provisions not to be viewed as modifications to IBC, but rather as limitations on the exceptions in NFPA 13R.
- Where a building is not required to be sprinklered, it is not intent to require sprinkler protection in the listed locations

906.1 Portable Fire Extinguishers

- New exception added:
 - Extinguishers not required in unoccupied Group U communication equipment structures



[F] 907.2.10 (New) Manual Alarms in Group S Buildings

- Manual fire alarm system now required for interior corridors and interior common areas in Group S public- and self-storage occupancies three stories or greater in height
- Visible notification appliances not required within storage units.
- Manual fire alarms boxes not required where building is fully sprinklered and occupant notification appliances activate throughout notification zones upon sprinkler water flow



[F] 907.5.2.1.3 (New) Fire Alarm Occupant Notification

Where a fire alarm system is required in Group R-1 and R-2 occupancies, a low-frequency signal shall be used in the sleeping rooms to improve the waking effectiveness of the occupant notification devices.



- In R-1 and R-2 sleeping rooms, the audible fire alarm activated by the fire alarm system to now be a 520-Hz low-frequency signal.
 - Where smoke alarm unable to produce a 520-Hz signal, the signal to be provided by a listed notification appliance or smoke detector with an integral 520-HZ sounder.
- Low frequency signals have been shown to improve the waking effectiveness for several high-risk groups.
- As there are currently very few smoke alarms capable of providing the low-frequency signal, particularly in back-up mode, other methods include:
 - Fire alarm system horns and horn/strobes
 - Smoke detectors w/integral sounder bases
 - Speakers connected to an EV/AC system

909.20 Smokeproof Enclosures

A new alternative method of pressurizing both the stair enclosure and the vestibule relative to the fire floor has been established for smokeproof enclosures.

- Fourth option added for the construction of such enclosures
- New method utilizes a pressurized stairway and a pressurized entrance vestibule
 - In addition, a controlled relief vent is to be located in the upper portion of the pressurized exit enclosure.
- Allows for a combination of existing methods by including a vestibule and using the pressurization between the exit enclosure and the vestibule to minimize smoke entrance into the stairway enclosure.
- Method will work well for high-rise buildings with stack effect conditions due to building height and outdoor air temperatures.
- May be more effective and/or economical than other methods

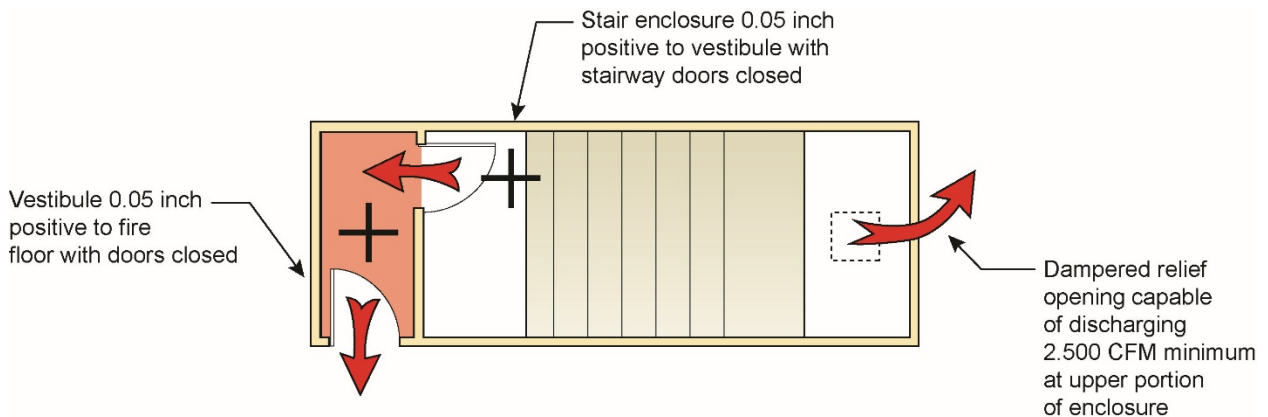

[F] 911 Fire Command Centers in Groups F-1 and S-1

- Fire command center now required in Group F-1 and S-1 occupancies with building footprint > 500,000 ft²
- Fire command center to be > 96 ft² with a minimum dimension of 8 ft

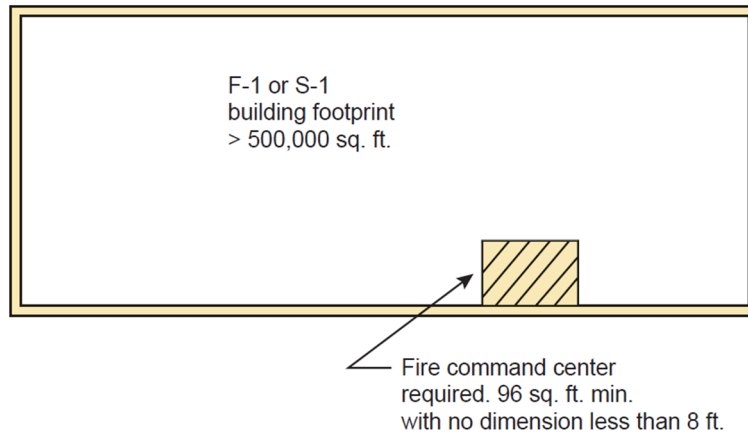

918 In-Building Emergency Communications Coverage

This change was developed during the in-building emergency communications (IBEC) study group to provide references to the IFC, which in turn provides technical provisions for IBEC systems that otherwise do not exist in the building code.

- Installation of such systems shall comply with IFC 510.4 and 510.5
- Acceptance and testing is the responsibility of the locality

918.1.1 Installation

Building owner is now required to install simply “cabling” instead of “radiating cable, such as coaxial cable or equivalent”. This opens the door to use emerging technology that can be used for in-building emergency communication systems.

- Required cable or cabling is no longer required to be “radiating”

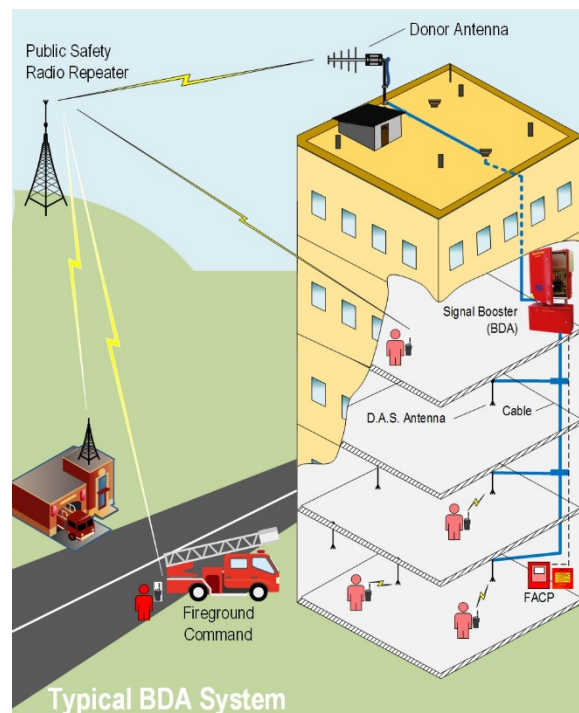

IFC 510.4 and 510.5

Although Section 918 of the VCC has been modified this cycle to reference Sections 510.4 and 510.5 of the IFC for in-building emergency communications, practically speaking, the entire Section 510 of the IFC would be new to most VA code enforcement personnel. If you are familiar with the existing IFC requirements, please be aware that Section 510 has received multiple changes. A selection of examples are included here.

- Mostly new to VA
- Section revised in 2021 edition



IFC 510.4.1, 510.4.1.1, 202 Emergency Responder Communication Coverage - Signals

The testing criteria for in-building 2-way emergency responder coverage systems is enhanced by requiring 99 percent coverage in critical areas

- Adequate coverage for in-building 2-way emergency responder communication coverage is $\geq 95\%$ in all areas AND $\geq 99\%$ coverage in critical areas
- Testing criteria is DAQ ≥ 3.0 AND ≥ -95 dBm

IFC 510.4, 510.4.2.4, 510.4.2.5, 510.4.2.8, 510.5.1 (New), 510.5.4 Emergency Responder Communication Coverage - Interference

Addresses potential sources of radio interference to in-building 2-way emergency responder communication coverage systems.

- Equipment for in-building, 2-way emergency responder communication coverage listed to UL 2524
- Must be provided with oscillation detection
- Signal boosters and RF-emitting devices must have built-in oscillation detection and control capability



IFC 510.5.1 Emergency Responder Communication Coverage – Antenna

- Donor antennas on the building must be:
 - Permanently affixed to building, OR
 - Mounted on a movable sled so they can be properly repositioned
 - Sign is required where mounted on movable sled:

**MOVEMENT OR REPOSITIONING OF THIS
ANTENNA IS PROHIBITED WITHOUT
APPROVAL FROM THE FIRE CODE OFFICIAL**

1006.2.1 Egress from Mechanical Rooms and Penthouses

- Common path of travel distance limitations are no longer applicable to unoccupied mechanical rooms and penthouses.
- These limited use spaces continue to be regulated based on:
 - Occupant load (Table 1006.2.1)
 - Exit access travel distance (Table 1017.2)

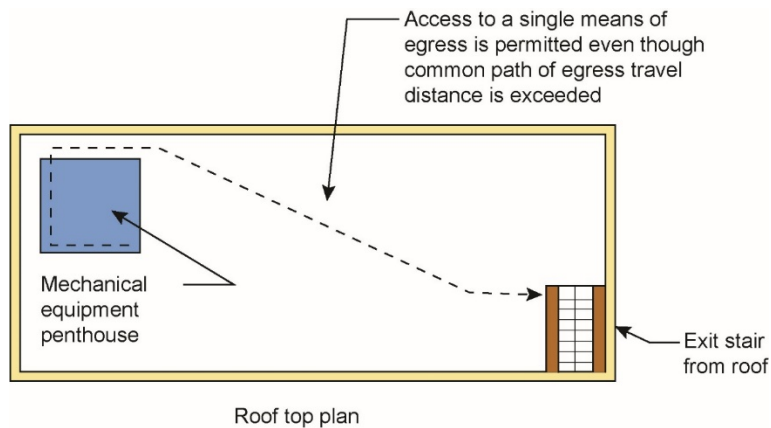

1006.3 Egress from Occupied Roofs

- Means of egress provisions applicable to occupied roofs have been established to provide consistency with those requirements for stories.



1006.3.4 Single Exit Stories

- Formerly 1006.3.3
- For single-exit stories, limitations on egress travel are now based on the exit access travel distance rather than the common path of egress travel.
- The revision impacts the end point of the travel measurement.
- Will result in a more restrictive application as occupants must reach door of an exit within travel distance limit.
- Reaching a point along a divergent path where two means of egress are available is no longer acceptable.
- Change is limited to the application of egress from stories per 1006.

TABLE ~~1006.3.3(1)~~ 1006.3.4(1) Stories with One Exit or Access to One Exit for R-2 Occupancies

Story	Occupancy	Maximum Number of Dwelling Units	Maximum Common Path of Egress Exit Access Travel Distance
Basement, first, second or third story above grade plane	R-2 ^{a,b}	4 dwelling units	125 feet
Fourth story above grade plane and higher	NP	NA	NA

For SI: 1 foot = 3048 mm.

NP = Not Permitted.

NA = Not Applicable.

a. Buildings classified as Group R-2 equipped throughout with an automatic sprinkler system in accordance with Section 903.3.1.1 or 903.3.1.2 and provided with emergency escape and rescue openings in accordance with Section ~~1030~~ 1031.

b. This table is used for R-2 occupancies consisting of dwelling units. For R-2 occupancies consisting of sleeping units, use Table ~~1006.3.3(2)~~ 1006.3.4(2).

TABLE ~~1006.3.3(2)~~ 1006.3.4(2) Stories with One Exit or Access to One Exit for Other Occupancies

Story	Occupancy	Maximum Occupant Load per Story	Maximum Common Path of Egress Exit Access Travel Distance (Feet)
First story above or below grade plane	A, B ^b , E, F ^b , M, U	49	75
	H-2, H-3	3	25
	H-4, H-5, I, R-1, R-2 ^{a,c}	10	75
	S ^{b,d}	29	75
Second story above grade plane	B, F, M, S ^d	29	75
Third story above grade plane and higher	NP	NA	NA

For SI: 1 foot = 304.8 mm.

NP = Not Permitted.

NA = Not Applicable.

a. Buildings classified as Group R-2 equipped throughout with an automatic sprinkler system in accordance with Section 903.3.1.1 or 903.3.1.2 and provided with emergency escape and rescue openings in accordance with Section ~~1030~~ 1031.

b. Group B, F and S occupancies in buildings equipped throughout with an automatic sprinkler system in accordance with Section 903.3.1.1 shall have a maximum exit access travel distance of 100 feet.

c. This table is used for R-2 occupancies consisting of sleeping units. For R-2 occupancies consisting of dwelling units, use Table ~~1006.3.3(1)~~ 1006.3.4(1).

d. The length of exit access travel distance in a Group S-2 open parking garage shall be not more than 100 feet.

1006.3.4 Single Exit Stories (continued)

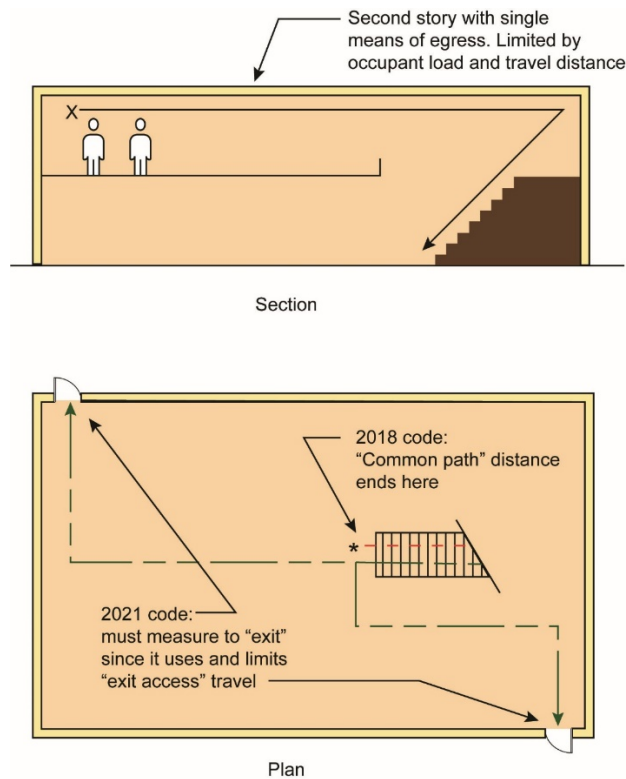

1008.2.1 Stairway Illumination

The minimum illumination level for both exit and exit access stairways has been increased from 1 foot-candle to 10 foot-candles.

- Exit stairways, exit access stairways and their associated landings must now have an illumination level under normal power of at least 10 footcandles.
 - Measured at the walking surface
 - Not applicable to stairs in exit discharge
 - Required only when stairway is in use, allowing for occupant-sensor or daylight-responsive controls
 - Exceptions for auditoriums, theaters and similar assembly occupancies still applicable
- Considered as an easily accomplished means for improving stairway safety

1009.2.1 Accessible Elevators to Occupied Roofs

The intent is to require accessible means of egress elevators for occupied roofs where they are located on roofs of buildings with 3 or more stories above the level of exit discharge.

- An elevator serving a required accessible occupied roof must now be considered as one of the required accessible means of egress where the roof is located directly above the 3rd story above the level of exit discharge.

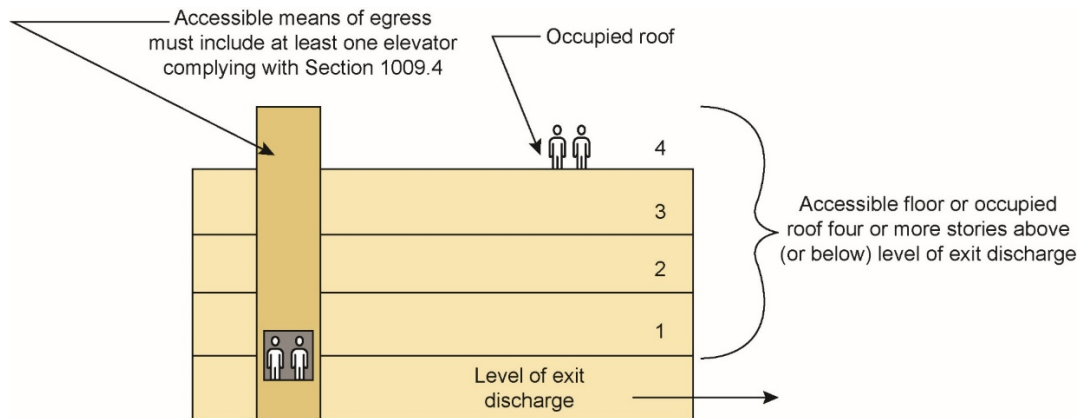

1009.6.2 Areas of Refuge

The use of an interior area of refuge at the level of exit discharge instead of an exterior area for assisted rescue is now permitted.

- An interior area of refuge no longer needs to have direct access to a complying stairway or elevator where the area of refuge:
 - Is located at the level of exit discharge, and
 - Provides direct access an exterior exit door.
- Allows for an alternative to an exterior area for assisted rescue which is typically utilized where the exit discharge is not accessible

1010.1.1 Door Widths

- The requirement limiting the maximum leaf size of a swinging egress door has been removed.
 - Previously limited to 48 inches wide
- The provision was primarily established due to weight issues with larger doors, often resulting in the need for greater maintenance to maintain:
 - Proper functioning
 - Reasonable opening effort
- It was determined that the maximum force provisions will continue to provide for complying swinging doors.
- Deletion allows for wider doors where needed, such as hospitals
- Revisions regarding doors to small spaces not required to be accessible:
 - Minimum width of 20 inches (new)
 - Now includes dressing, fitting and changing rooms (in addition to shower and sauna compartments and toilet stalls)
 - Specifies “single-user” spaces to better define intent

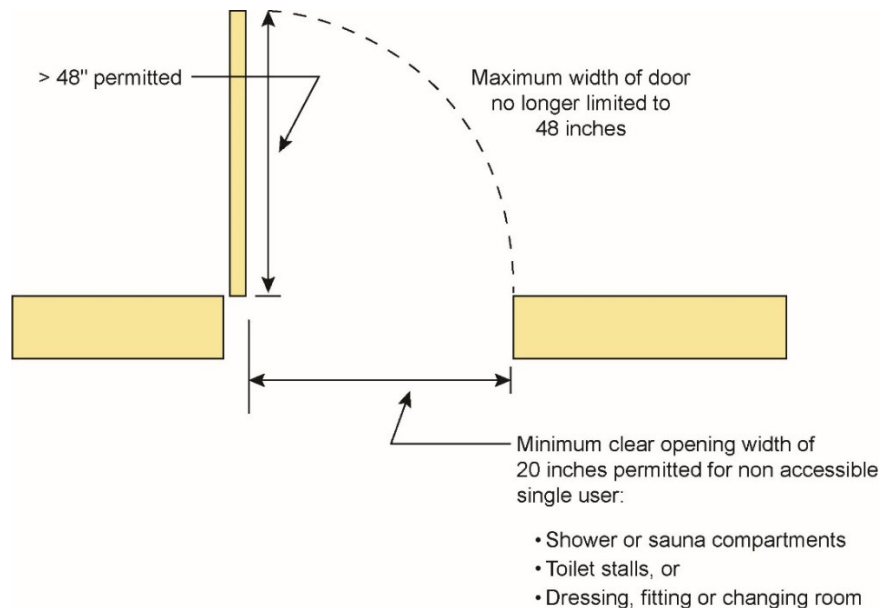

1010.1.1.1 Projections into Door Openings

Additional components are now specifically permitted to project into the minimum required door opening height.

- Additional components are now permitted to encroach into the minimum required door opening height.
- In addition to those previously allowed (door closers and door stops), the following items are permitted to be 78 inches minimum above the floor:
 - Power door operators
 - Electromagnetic locks



1010.2.4 Locks and Latches

The general locking provisions have been expanded to allow locked doors in the egress system when desired due to the clinical needs of care recipients or where exterior areas egress back through the building.

- Formerly 1010.1.9.4
- In I-1, Condition 2 and I-2 occupancies where clinical needs of care recipients require containment, or where such persons pose a security threat, locks and latches are permitted to prevent door operation where:
 - All clinical staff can readily unlock doors at all times, and
 - All such locks are keyed to keys carried by clinical staff at all times, or clinical staff have codes or other means necessary to operate the locks at all times.
- Locking devices now also permitted on doors to balconies, decks and other exterior spaces serving:
 - Private office spaces where exterior space < 250 sqft
 - Individual dwelling or sleeping units
- Where occupants must egress from an exterior space through the building, exit access doors permitted to equipped with an approved locking device.
- Applicable to enclosed courtyards, occupied roofs, decks and other exterior areas
- Not applicable to egress courts
- Six conditions must be met in order for the locking devices to be permitted:
 - Maximum occupant load posted per Section 1004.9 inside building adjacent to all exit access doorways
 - Weatherproof telephone or two-way communication system installed on exterior side adjacent to at least one required exit access door
 - Locking device to be key-operated and readily distinguishable as locked
 - Minimum 5 square-foot clear window or glazed door opening provided at each exit access door
 - Signage posted on interior side at each locked door stating “THIS DOOR TO REMAIN UNLOCKED WHEN THE OUTDOOR AREA IS OCCUPIED”
 - Occupant load of exterior area limited to 300

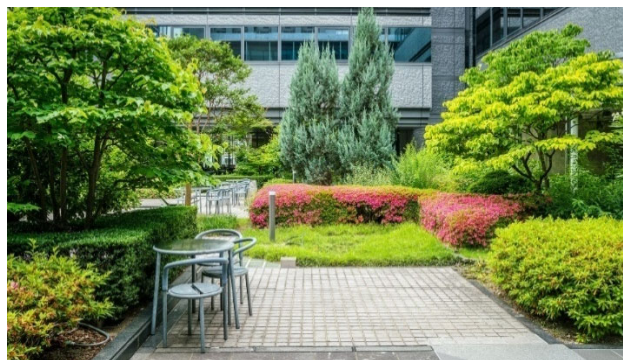



108.1, 110.1, 202, 1010.2.8, 1103.2.15 Emergency Supplemental Hardware

The intent of this change is to comply with the SB 333 and HB 670 by expanding on the existing provisions for emergency supplemental hardware (ESH). The gist is the addition of "public buildings" to the list of uses/occupancies already allowed to be provided with ESH.

The proposal was generated as a result of discussions during the Active Shooter and Hostile Threats in Public Buildings - Study Group, convened pursuant to the aforementioned bills. For more information on the Study Group activities and discussions, please see attached Study Group Report.

- Formerly 1010.1.4.4 Locking arrangements in educational occupancies
- Allows the installation of ESH in "public buildings" which is now defined

1011.6 Stairway Landings

- Where curved stairways of constant radius have intermediate landings, landing depth to be measured horizontally between:
 - Intersection of walkline of lower flight at landing nosing, and
 - Intersection of walkline of upper flight at nosing of lowest tread of upper flight.

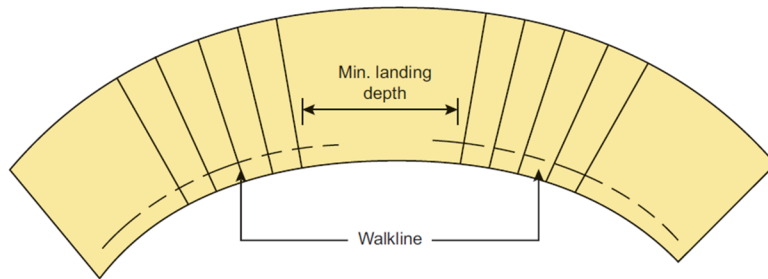

Landing depth at curved stairway.

- Where landing turns 90° or more, minimum landing depth not regulated where landing provided is not less than that described by an arc with a radius equal to width of the flight served.

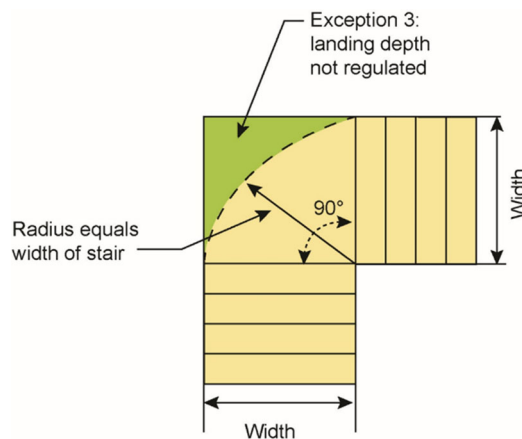

1019.3 Exit Access Stairways

- The allowance for exit access stairways serve or atmospherically communicate between two stories has been clarified to limit such communication to adjacent stories.
- The change more clearly indicates the intent that such connection only address those stories that are directly adjacent to each other.

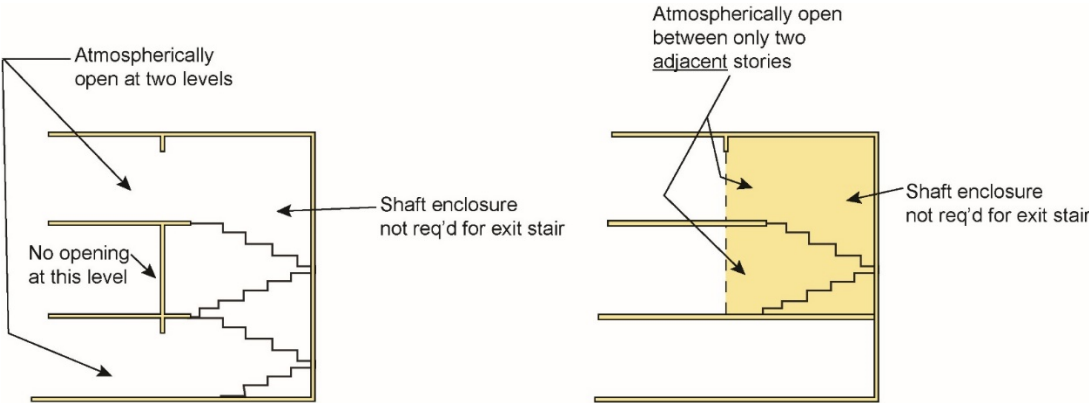

Table 1020.1 Corridor Fire Resistance Rating



- Reinstates 1-hour corridor rating for Group I-1



1020.2.1 Hoistway Opening Protection Deleted



The VCC has historically eliminated the requirement for hoistway opening protection in 3006. Note that for the 2021 VCC, Section 3006 has been reintroduced, but only as an option for compliance with other requirements of the code and not as a mandate.

- Deletes reference to 3006, which has historically been deleted by Virginia



1020.5 Dead-End Corridors

In hospitals, a corridor that does not serve patient rooms or treatment spaces is now allowed a maximum 30-foot dead end.

- Formerly 1020.4
- In hospitals, corridors now permitted to have 30-ft-maximum dead-end conditions where not serving patient rooms or treatment spaces.
 - Provides consistency with NFPA 101 and CMS requirements
- 20 ft limitation still applicable to corridors serving patient rooms and treatment areas.



1026.2 Separation



- Openings in horizontal assemblies on the story served by horizontal exits shall be protected in accordance with 712.1.1, 712.1.3, and 712.1.13
- Previously given the option of the above or 1019.3 Item 4

1030.16 Handrails at Social Stairs

Guidance is now provided to address what are often called “social stairs,” which are regulated by a combination of the general stairway provisions and those for assembly seating.

- Formerly 1029.16
- Guidance provided to address handrails on those stairs, primarily in A and E occupancies, that are a combination of stairway travel and assembly seating.
- Based on the assembly stepped aisle provisions, the condition is viewed as an assembly seating area with the seating platforms (without seats) located to the side of the stepped aisle.
- Where the stepped aisle has seating on one side and the aisle width is at least 74 inches, two handrails are required (with at least one within 30 inches of the stepped aisle).
 - Where the stepped aisle is required to have two handrails, mid-aisle handrails to be discontinuous.

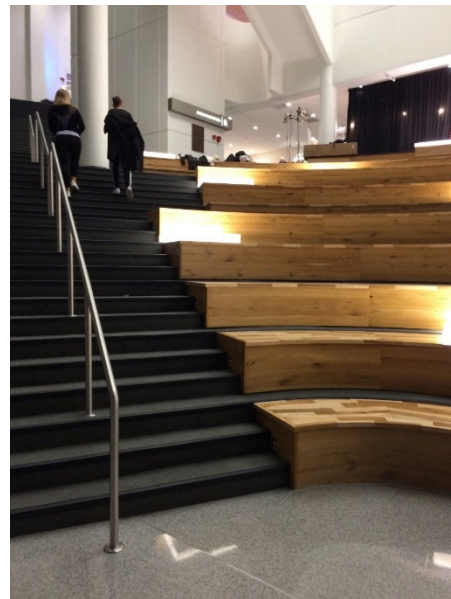
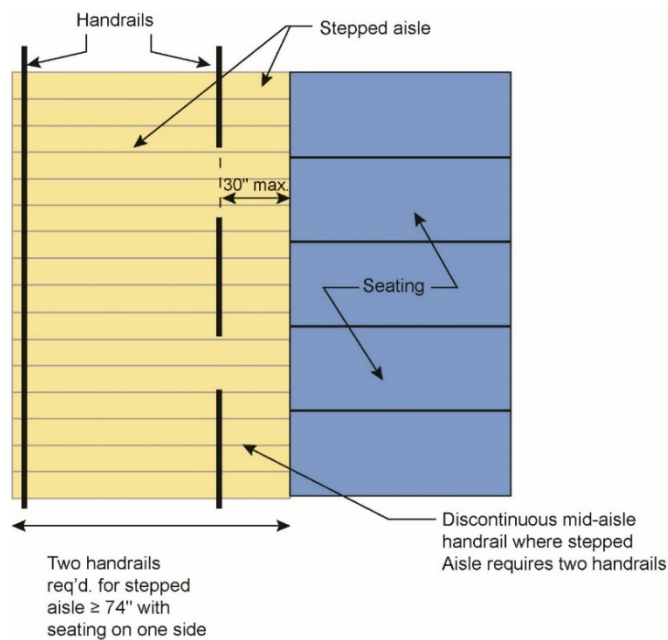

1031 Emergency Escape and Rescue Openings

- Formerly 1030.1
- Provisions reorganized and reformatted for clarity
- Two slight modifications occurred:
 - Where a door is used as an EERO, it must be a sliding door or a swinging door
 - Where steps are used from a window well serving an EERO, they must be at least 12 inches wide, have treads more than 5 inches in depth, and have a maximum riser height of 18 inches for the full height of the area well.

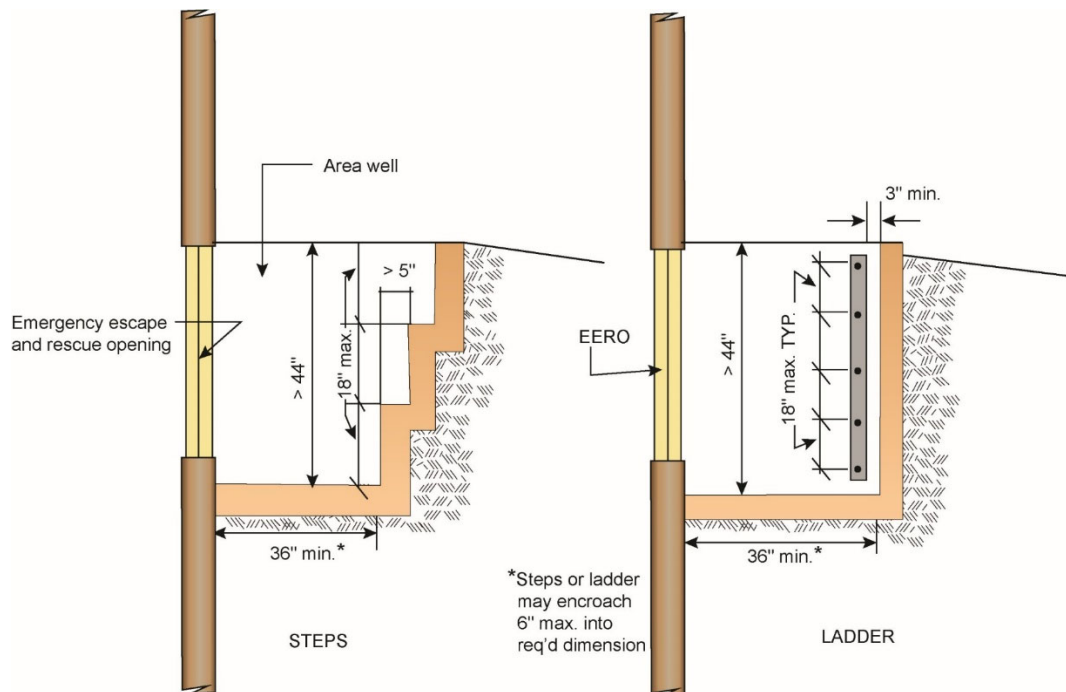

1102 Accessible Design Compliance

- The ICC A117.1 standard as referenced by the IBC for the design and construction of accessible buildings and facilities has been updated from the 2009 edition to the 2017 edition.
- Many of the major revisions are addressed in the ICC publication Significant Changes to the ICC A117.1 Accessibility Standard, 2017 Edition, including:
 - Enhanced dimensions for clear floor spaces and turning spaces.
 - Modifications to exterior routes, curb cuts, blended transitions, detectable warnings, passenger drop-offs and parking facilities.

1104.4 Accessible Multistory Buildings

- The application of the 3,000 square-foot exclusion for a vertical accessible route is now prohibited in buildings having four or more dwelling units.
 - Provides for compliance with Fair Housing Act

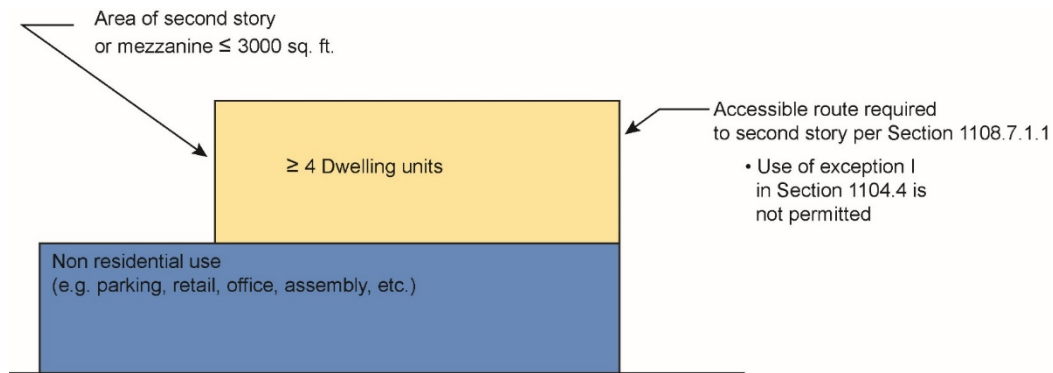

1105.1.1 (New), Table 1105.1.1 – Automatic Doors at Public Entrances

- In specified occupancies with sizable occupant loads, the accessible public entrances must now be provided with an automatic door.
 - Where an automatic door is required by Table 1105.1.1, it shall be either a full power-operated door or a low-energy power-operated door.
- In mixed-occupancy buildings where total building occupant load exceeds that listed, the most restrictive building occupant load shall apply.
- Where the public entrance includes a vestibule, at least one door into and one door out of the vestibule must comply with the requirements.

TABLE 1105.1.1 Public Entrance with Power-Operated Door^a

Occupancy	Building Occupant Load Greater Than
A-1, A-2, A-3, A-4	300
B, M, R-1	500

a. In mixed-use facilities where the total sum of the building occupant load is greater than those listed, the most restrictive building occupant load shall apply.

1107.2 Vehicle Charging Stations

Scoping provisions have been provided to make electrical vehicle charging stations accessible.



- New scoping provisions now require electrical vehicle charging stations to meet limited accessibility criteria.
 - Charging stations provided to serve R-2, R-3 and R-4 occupancies are not required to comply.
- To be viewed as a “service” rather than a parking space
- Installation not required, but if provided must meet these requirements:
 - Minimum of 5% of vehicle spaces on site, but not less than one of each type of system, shall be accessible.
 - Accessible vehicle spaces to comply as for a van accessible parking space, with:
 - 132 inches minimum width, and
 - Minimum 60-inch-wide access aisle.

1108.5, 1110.2 Assisted Toileting and Bathing

A series of changes were made to the assisted living and nursing home provisions to allow some units to have toilet and bathing facilities designed for assisted use instead of the independent use generally intended by the ICC A117.1 Accessible unit provisions.

- Changes have been made to the provisions for nursing homes and assisted living facilities to allow some units to have toilet and bathing facilities designed for assisted use.
 - These allowances are permitted instead of the independent use facilities generally intended by the ICC A117.1 Accessible unit provisions.
- Both scoping and technical provisions are provided in IBC.
- The assisted use provisions are optional and can be applied when desired by the designer.
 - Units may be modified for toileting, bathing or both
- Assisted water closets and roll-in-type showers may replace like fixtures in up to 50% of Accessible units in the following occupancies:
 - I-1, Conditions 1 and 2
 - I-2 rehabilitation facilities
- Assisted water closets and roll-in-type showers may replace like fixtures in up to 90% of Accessible units in the following occupancies:
 - I-2 nursing homes
- Primary technical changes include:
 - Increased clearance around water closet of 66” with clearance of 24” to 26” from centerline of fixture
 - Increased clearance depth of 78” to allow for additional approach options
 - Allowance for swing-up grab bars that are typically only permitted in Type B units
 - Toilet paper dispenser to be installed on at least one of the swing-up grab bars

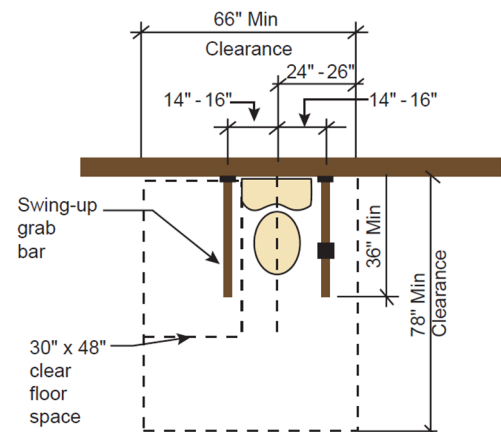

1108.5, 1110.2 Assisted Bathing (continued)

- Primary technical change is elimination of required folding seat
- Allows for use of rolling chair when necessary
- Sidewall and backwall grab bars now differ, with side-wall bar required on 'seat wall' and both grab bars starting in corners

1110.6 Bottle Filling Stations (New)

- Water bottle-filling stations, where provided, are to be accessible.
 - Stations located over drinking fountains for standing persons not required to be accessible, provided such stations are also located over the drinking fountains for persons using wheelchairs.
- Technical requirements found in A117.1 Section 602.4.
 - Clear floor space provided for either a forward or side approach
 - Controls to comply with operable parts requirements



1110.13.2 Service Windows

Sales and service counters now specifically address windows, and such elements are to be accessible whether or not a counter is provided at that location.

- Windows where sales and/or service is provided are now required to be accessible even if no counter is provided.
- One of each window type shall be accessible
- Where dispersed throughout building, accessible windows to also be dispersed.
- ICC A117.1 Section 904.3 provides technical criteria.

1110.15 Operable Parts

A new reference to the operable parts provisions of ICC A117.1 allows the removal of like exceptions from the IBC.

- A117.1 Section 309.1 is now referenced regarding those operable parts exempted from accessibility, allowing for the deletion of like exceptions in IBC.
 - Five exceptions deleted from IBC to:
 - Eliminate redundancy and confusion
- Maintain consistency between ICC A117.1 and IBC
- Exceptions addressed include:
 - One kitchen counter top outlet where two or more provided
 - One control, for other than light switches, where redundant controls are provided
 - Electrical receptacles serving dedicated use
 - Floor electrical receptacles
 - HVAC diffusers



1202.3 Insulation of Unvented Attics

A new option is available for the regulation of unvented attics with air-permeable insulation and vapor diffusion ports in warmer climates.

- A new option is available for the regulation of unvented attics with air-permeable insulation through the use of vapor diffusion ports in warmer climates.
- VAPOR DIFFUSION PORT. An assembly constructed or installed within a roof assembly at an opening in the roof deck to convey water vapor from an unvented attic to the outside atmosphere.

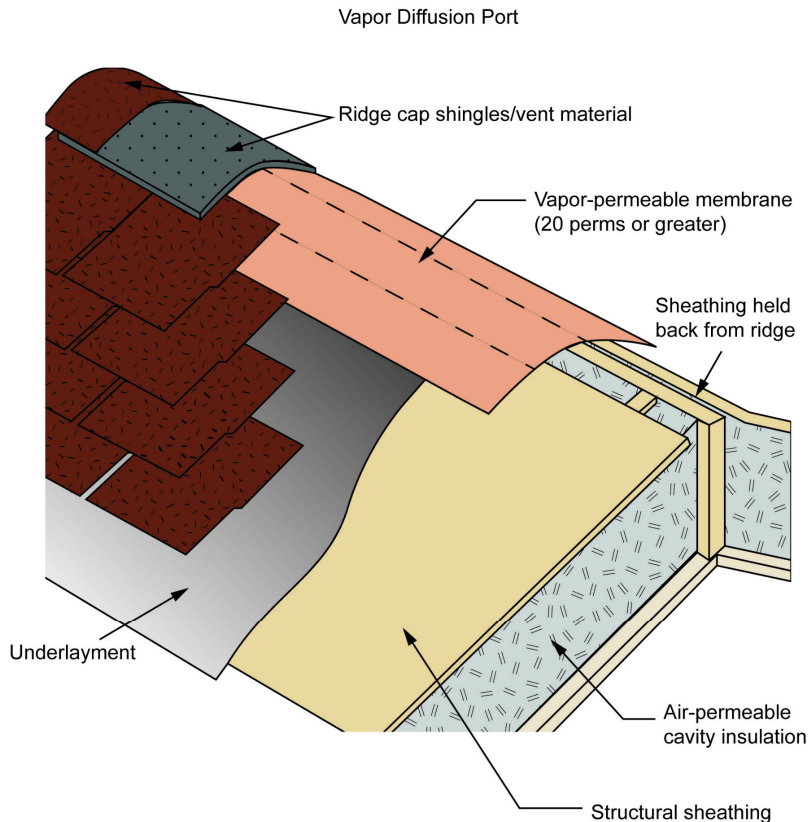

- New Condition 5.2, an option to Condition 5.1, includes the following requirements:
 - Applicable only in Climate Zones 1, 2 and 3
 - Vapor diffusion port to be installed ≤ 12 inches of roof's highest point
 - Port area to be $\geq 1/600$ of ceiling area
 - Membrane to have vapor permeance rating of ≥ 20 perms
 - Vapor diffusion port to serve as air barrier between attic and exterior
 - Vapor diffusion port to protect attic against entrance or rain and snow
 - Framing shall not block free flow of water vapor to port.
 - Roof slope to be ≥ 3 units vertical in 12 units horizontal

1207 Enhanced Classroom Acoustics (New)

Educational occupancies are now required to meet the enhanced classroom acoustic requirements of Section 808 of ICC A117.1.



- In Group E occupancies, enhanced classroom acoustics shall be provided in all classrooms 20,000 cubic feet or less.
- Such acoustics to be in compliance with Section 808 of ICC A117.1, including regulation of:
 - Reverberation times based on either the performance method or prescriptive method
 - Ambient sound levels from sources both inside and outside of the classroom
- Good acoustics are essential to support language acquisitions and learning for all children.
- Assistive technologies typically only amplify the teacher and do not amplify discussions between students or between teacher and individual student.
- Intended to apply to standard-sized self-contained classrooms, but not larger spaces for activities such as band or choir.
 - Also not intended to apply to ancillary spaces, such as individual tutoring rooms, corridors, or a cafeteria.
- In addressing reverberation times, both performance and prescriptive methods are available.
- Ambient sound levels not to exceed 35 dBA and 55 dBC

1208.4 Efficiency Dwelling Units

The minimum required floor area of an efficiency dwelling unit has been reduced to 190 square feet, and a definition of an efficiency dwelling unit has been added.

- Formerly 1207.4
- A definition for an efficiency dwelling unit has been added.
 - DWELLING UNIT, EFFICIENCY. A dwelling unit where all permanent provisions for living, sleeping eating and cooking are contained in a single room.
- The minimum required floor area of an efficiency dwelling unit has been reduced from 220 to 190 ft².
 - Based on minimum required room sizes of 120 ft² plus 70 ft²
- Mandate of providing additional 100 ft² of floor area for each occupant in excess of two has been deleted.

[P] 1210.3 Restroom Privacy

- Formerly [P] 1209.3
- Privacy concerns addressed by requiring a screening element at the entry to the public restroom.
 - Not applicable to single-occupant toilet rooms with a lockable door.
- Also applicable where mirrors would compromise personal privacy.



1404.3 Vapor Retarders (New)

Vapor retarder provisions have been reorganized and thresholds clarified for when a vapor retarder is required and which retarder is required as well as location and climate zone requirements.

- Vapor retarder provisions have been reformatted, utilizing new tables and text to assist in selecting appropriate materials based on climatic conditions and desired vapor retarder class.
- Where paint or other approved materials are used, they are to be applied in accordance with the manufacturer’s instructions to achieve the required perm rating.

Class I



VR < 0.1 perm
Impermeable
Foil and Polyethylene sheets

Class II

0.1 perm < VR < 1 perm
Semi-impermeable
Extruded polystyrene and
Kraft fiberglass batts



Class III



1 perm < VR
Semi-impermeable
Latex paint, 30# felt and Plywood

TABLE 1404.3(1) Vapor Retarder Materials and Classes

<u>Vapor Retarder Class</u>	<u>Acceptable Materials</u>
<u>I</u>	<u>Sheet polyethylene, nonperforated aluminum foil, or other approved materials with a perm rating of less than or equal to 0.1</u>
<u>II</u>	<u>Kraft-faced fiberglass batts or vapor retarder paint or other approved materials, applied in accordance with the manufacturer's instructions for a perm rating greater than 0.1 and less than or equal to 1.0</u>
<u>III</u>	<u>Latex paint, enamel paint, or other approved materials, applied in accordance with the manufacturer's instructions for a perm rating of greater than 1.0 and less than or equal to 10</u>

Table 1404.3(4) Class II Vapor Retarders (New)

- Assigns minimum continuous insulation R-values where Class II vapor retarders are installed
- Now coordinates with requirements for vapor retarders with typical insulation requirements found in the IECC for wood-framed wall assemblies
 - Assures an adequate amount of continuous insulation is used with a Class I interior vapor retarder to keep wall interiors sufficiently warm to control condensation and moisture accumulation.

1406.10 Metal Composite Material Cladding

MCMs and systems installed on buildings of Type I, II, III and IV construction are now regulated based upon one of two conditions:

1. Such installations over 40 ft above grade plane must comply with:
 - Surface-burning characteristics
 - Flame spread index ≤ 25
 - Smoke developed index ≤ 450
 - Thermal barrier separation
 - Minimum $\frac{1}{2}$ " gypsum board or test per NFPA 275
 - Acceptance criteria of NFPA 285; or be equipped throughout with NFPA 13 system (per existing VA amendment)
 - Addresses exterior nonloadbearing wall assemblies containing combustible components
 2. Such installations that do not exceed 40 ft above grade plane need only comply with surface-burning characteristics and thermal barrier separation.
- Previously, all MCM cladding on buildings of other than Type V to meet all three conditions, or meet alternative conditions of Section 1406.11
 - Allowance for use of alternative conditions has been deleted, thus removing issues addressing:
 - Fire separation distance
 - MCM surface area limitation and separation
 - Sprinkler protection throughout building



1503.3 Parapet Walls

- Parapet walls now require moisture resistance in a manner similar to the remainder of the building.
- Specific modifications include:
 - Parapet coping and covering materials are no longer required to be noncombustible.
 - Top surface of the parapet wall to provide positive drainage.
- Where parapet wall required to be fire-resistance rated, it must be coped or covered with materials that are both weatherproof and maintain the required fire-resistance.
- Where a fire-resistive parapet wall is not required, it only needs to be covered or coped with weatherproof materials.



1504.5 Ballasted Roofs

All requirements applicable to the design and construction of ballasted low-slope roofs are now contained in the ANSI/SPRI RP-4 standard.

- Formerly 1504.4
- Design for ballasted low-slope roofs are now contained in the ANSI/SPRI RP-4 standard, Wind Design Standard for Ballasted Single-ply Roofing Systems.
- Requirements of SPRI RP-4 are based on a complete set of wind tunnel tests
 - In test series, variables that impact the wind performance of ballasted single-ply roof assemblies were evaluated, including stone size and distribution.
 - Three critical wind speeds were identified for each condition of parapet height and stone size:
 - Wind speed 1 – speed at which stone first begins to move
 - Wind speed 2 – speed, if maintained, that results in stone scouring
 - Wind speed 3 – speed at which stone blow-off occurs
 - Requirements in design tables are based on wind speed 2.

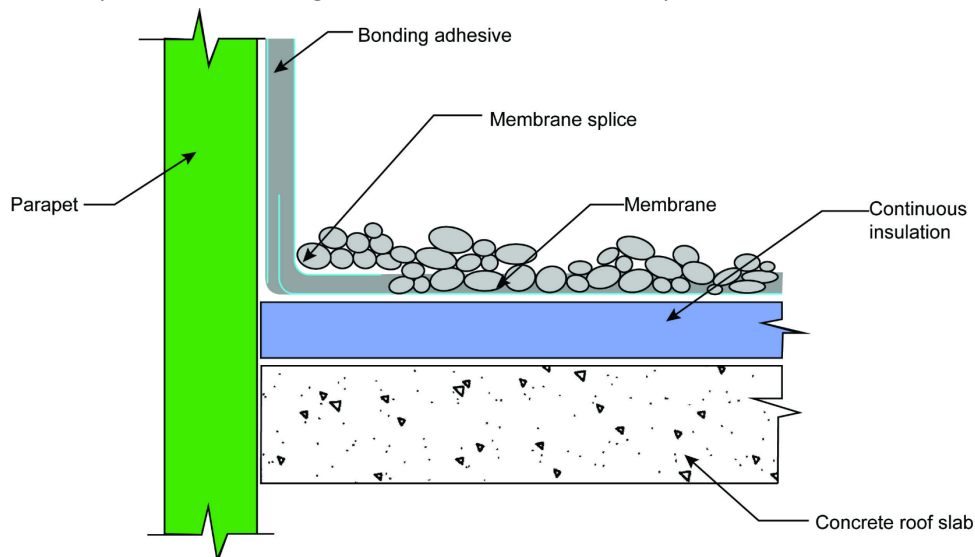

1504.9 Aggregate-Surfaced Roofs (New)

Parapets of a minimum height are now required for aggregate-surfaced roofs to prevent blow-off.

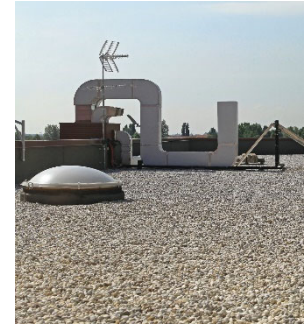

- Minimum parapet heights have been established for aggregate-surfaced roofs to prevent blow-off.
- New Table 1504.9 now mandates minimum heights based on:
 - Aggregate size
 - Mean roof height
 - Wind exposure
 - Basic design wind speed
- Provides engineering and scientific basis for roof design to prevent blow-off based on wind tunnel tests and subsequent field studies of hurricane damage.
- Past provisions were not based on a quantitative analysis of observed roofing system performances on real wind events, but rather variations in surface pressure with building height
- Table 1504.8 previously either permitted or prohibited aggregate used as surfacing for roof coverings or ballast solely based on:
 - Maximum mean roof height
 - Design wind load
 - Exposure category
- Conditions where no parapets are provided are no longer allowed

TABLE 1504.9 Minimum Required Parapet Height (inches) for Aggregate Surfaced Roofs^{a,b,c}

Aggregate Size	Mean Roof Height (ft)	Wind Exposure and Basic Design Wind Speed (mph)																	
		Exposure B									Exposure C ^d								
		≤95	100	105	110	115	120	130	140	150	≤95	100	105	110	115	120	130	140	150
ASTM D1863 (No.7 or No.67)	15	2	2	2	2	12	12	16	20	24	2	13	15	18	20	23	27	32	37
	20	2	2	2	2	12	14	18	22	26	12	15	17	19	22	24	29	34	39
	30	2	2	2	13	15	17	21	25	30	14	17	19	22	24	27	32	37	42
	50	12	12	14	16	18	21	25	30	35	17	19	22	25	28	30	36	41	47
	100	14	16	19	21	24	27	32	37	42	21	24	26	29	32	35	41	47	53
ASTM D1863 (No.6)	15	2	2	2	2	12	12	12	15	18	2	2	2	13	15	17	22	26	30
	20	2	2	2	2	12	12	13	17	21	2	2	12	15	17	19	23	28	32
	30	2	2	2	2	12	12	16	20	24	2	12	14	17	19	21	26	31	35
	50	12	12	12	12	14	16	20	24	28	12	15	17	19	22	24	29	34	39
	100	12	12	14	16	19	21	26	30	35	16	18	21	24	26	29	34	39	45
150	12	14	17	19	22	24	29	34	39	18	21	23	26	29	32	37	43	48	

For SI: 1 inch = 25.4 mm; 1 foot = 304.8 mm; 1 mile per hour = 0.447 m/s.

a. Interpolation shall be permitted for mean roof height and parapet height.

b. Basic design wind speed, V, and wind exposure shall be determined in accordance with Section 1609.

c. Where the minimum required parapet height is indicated to be 2 inches (51 mm), a gravel stop shall be permitted and shall extend not less than 2 inches (51 mm) from the roof surface and not less than the height of the aggregate.

d. For Exposure D, add 8 inches (203 mm) to the parapet height required for Exposure C and the parapet height shall not be less than 12 inches (305 mm).

1602.1, 1603.1.4, 1605.1, 1607.14, 1609.5, 1609.6, 2308.2.3 Tornado Loads

State Code Change

- Virginia now designated as a tornado prone region
- Provisions specific to tornado loads have been added
- Revised definitions for:
 - [BS] ESSENTIAL FACILITIES. Buildings and other structures that are intended to remain operational in the event of extreme environmental loading from flood, wind, tornadoes, snow or earthquakes.
 - [BS] NOMINAL LOADS. The magnitudes of the loads specified in Chapter 16 (dead, live, soil, wind, tornado, snow, rain, flood and earthquake).
 - [BS] RISK CATEGORY. A categorization of buildings and other structures for determination of flood, wind, tornado, snow, ice and earthquake loads based on the risk associated with unacceptable performance.



Table 1604.5 Assembly Spaces and I-4 Occupancies in Risk Category III

Mixed occupancy buildings with assembly spaces are now designated as Risk Category III when the total public assembly occupant load is greater than 2,500 people.

- Risk Category III has been assigned to those buildings whose primary occupancy is not public assembly, but have one or more public assembly spaces with an occupant load > 300 and a cumulative occupant load of such assembly spaces > 2,500.
 - Eliminates inconsistency in risks associated with large assembly spaces.
- Risk Category III also now applies to Group I-4 occupancies where occupant load > 250, or where combined occupant load of Groups I-4 and E > 250.

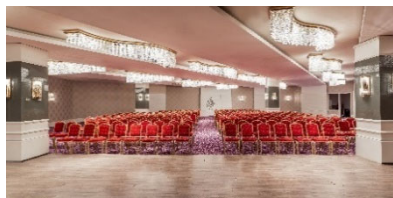

TABLE 1604.5 Risk Category of Buildings and Other Structures

Risk Category	Nature of Occupancy
III	<p>Buildings and other structures that represent a substantial hazard to human life in the event of failure, including but not limited to:</p> <ul style="list-style-type: none"> • Buildings and other structures whose primary occupancy is public assembly with an occupant load greater than 300. • <u>Buildings and other structures containing one or more public assembly spaces, each having an occupant load greater than 300 and a cumulative occupant load of the public assembly spaces of greater than 2,500.</u> • Buildings and other structures containing Group E <u>or Group I-4 occupancies or combination thereof</u>, with an occupant load greater than 250. <p><i>(Other Risk Category III criteria remain unchanged)</i></p>

Table 1604.5 Risk Category of Assembly Spaces in Risk Category III (continued)

- Risk Category III previously only applied to public assembly condition where the assembly activity is the primary occupancy and the occupant load > 300, such as a theater.
- Example of new RC III designation:
 - 5-story hotel with conference center where hotel is building's primary occupancy
 - 2 ballrooms with 1,200 occupants each
 - 3 meeting rooms with 90 occupants each
 - Total assembly occupant load: 2,670
 - At least one assembly room with > 300 occupants, and total assembly occupant load > 2,500, thus Risk Category III



1605 Load Combinations

The strength design and allowable stress design load combinations have been deleted while direct reference to Chapter 2 of ASCE 7 has been added to Section 1605.

- Strength design (SD/LRFD) (ASCE 7 § 2.3)
- Allowable stress design (ASD) (ASCE 7 § 2.4)
- Alternative ASD (IBC § 1605.2)
 - Omega factor, ω , has been deleted from the alternative allowable stress design load combinations



1606 Dead Loads

Dead loads at the roof level have been clarified as well as fixed service equipment concentrated loads.

- Weights of:
 - Construction materials
 - Walls
 - Floors
 - Roofs
 - Ceilings
 - Service equipment
 - Plumbing stacks and risers
 - Heating/cooling
 - Photovoltaic panels
 - Vegetative & landscaped roofs



1607.11.4 Rope Descent Systems

Rope descent system anchorage has been added to the section on fall arrest and lifeline anchorage.

- Formerly 1607.10.4
- Rope descent system anchorage added
 - 3,100 lbs
 - Any direction
- Anchorages of horizontal lifelines support elements require design for maximum tension force



1607.17 Fixed Ladder Live Load (New)

Live loads for fixed and ship's ladders have been added to the IBC.

- Fixed ladders with rungs
 - 300 lbs concentrated
- Side rail extension of fixed ladders above platform
 - 100 lbs concentrated
- Ship's ladders
 - Stair loads in Table 1607.1



1610.2 Soil-Caused Uplift (New)

Concrete slabs on ground must now be designed for uplift due to soil expansion and water pressure in areas prone to soil movement or a shallow water table.

- Expansive soils
- Water pressure



1611.1 Rain Loads

- Secondary drainage system rain loads updated consistent with ASCE 7



1704.6 Structural Observations

A structural observer must now visually observe the construction of structural systems for general design conformance for all buildings assigned to Risk Category III or IV.



- Two new classes of structures are now required to be provided with structural observation:
- Structures classified as Risk Category III (previously limited only to RC IV structures), and
- Structures in SDC E that are more than two stories above grade plane (no previous requirement based upon SDC)
- Recognizes substantial hazards that may be present in facilities considered as RC III structures, as well as those structural hazards involving multi-story structures in SDC E

Table 1705.3 Special Inspection of Precast Concrete

Special inspection requirements for precast concrete diaphragm connections have been added to the list of general concrete special inspections and tests.



- Continuous inspection
 - Precast diaphragm connections
 - Reinforced moderate- or high-deformability joints
 - SDC C-F

TABLE 1705.3 Required Special Inspections and Tests of Concrete Construction

Type	Continuous Special Inspection	Periodic Special Inspection	Referenced Standard
10. Inspect erection of precast concrete members.	–	×	ACI 318: 26.9
11. <u>For precast concrete diaphragm connections or reinforcement at joints classified as moderate or high deformability elements (MDE or HDE) in structures assigned to Seismic Design Category C, D, E or F, inspect such connections and reinforcement in the field for:</u>			
a. <u>Installation of the embedded parts</u>	×	–	ACI 318: 26.13.1.3
b. <u>Completion of the continuity of reinforcement across joints.</u>	×	–	
c. <u>Completion of connections in the field.</u>	×	–	ACI 550.5
12. <u>Inspect installation tolerances of precast concrete diaphragm connections for compliance with ACI 550.5.</u>	–	×	ACI 318: 26.13.1.3

1705.4.1 Empirically Designed Masonry

- Empirically designed masonry no longer allowed in Risk Category IV buildings



1705.10 Structural Integrity of Deep Foundations (New)

When installed deep foundation elements appear to be understrength due to quality, location or alignment, an engineering assessment must now be done.

- Engineering assessment required when deep foundation elements appear understrength due to quality, location, or alignment
- Tests added for assessing portion of foundation elements that cannot be visually inspected.

1709.5.3 Impact Protection (New)

Required windborne debris protection for glazing has been clarified through the addition of a design standard and a definition of impact protective systems.

- New definition:
IMPACT PROTECTIVE SYSTEM. Construction that has been shown by testing to withstand the impact of test missiles and that is applied, attached or locked over exterior glazing.
- Windborne debris glazing protection clarified
 - Design standard
 - Impact protective systems definition
- Testing and labeling
 - ASTM test standards
 - ASCE 7 wind pressures
 - Permanent label
 - Manufacturer
 - Product designation
 - Performance characteristics
 - Approved inspection agency



1809.5.1 Frost Protection at Required Exits (New)

Frost protection for egress doors has been added to the foundation requirements.

- Exterior landings
 - All required exits
 - Outward swinging doors
- Ensure unobstructed opening of required exit doors





Table 1810.3.2.6 Allowable Stresses in Deep Foundations

Maximum allowable stress for deep foundation materials updated consistent with materials used today

TABLE 1810.3.2.6 Allowable Stresses for Materials Used in Deep Foundation Elements

Material Type and Condition	Maximum Allowable Stress ^a
1. Concrete or grout in compression^b	
Cast-in-place with a permanent casing in accordance with Section 1810.3.2.7 or Section 1810.3.5.3.4	$0.4 f'_c$
Cast-in-place in a pipe, tube, other permanent casing or rock	$0.33 f'_c$
Cast-in-place without a permanent casing	$0.3 f'_c$
Precast nonprestressed	$0.33 f'_c$
Precast prestressed	$0.33 f'_c - 0.27 f_{pc}$
2. Nonprestressed reinforcement in compression	
	$0.4 f_y \leq 30,000 \text{ psi}$
3. Steel in compression	
Cores within concrete-filled pipes or tubes	$0.5 F_y \leq 32,000 \text{ psi}$
Pipes, tubes or H-piles, where justified in accordance with Section 1810.3.2.8	$0.5 F_y \leq 32,000 \text{ psi}$
Pipes or tubes for micropiles	$0.4 F_y \leq 32,000 \text{ psi}$
Other pipes, tubes or H-piles	$0.35 F_y \leq \del{16,000 \text{ psi}} \underline{24,000 \text{ psi}}$
Helical piles	$0.6 F_y \leq 0.5 F_u$
4. Nonprestressed reinforcement in tension	
Within micropiles	$0.6 f_y$
Other conditions	
For load combinations that do not include wind or seismic loads	$0.5 f_y \leq \del{24,000 \text{ psi}} \underline{30,000 \text{ psi}}$
For load combinations that include wind or seismic loads	$0.5 f_y \leq 40,000 \text{ psi}$
5. Steel in tension	
Pipes, tubes or H-piles, where justified in accordance with Section 1810.3.2.8	$0.5 F_y \leq 32,000 \text{ psi}$
Other pipes, tubes or H-piles	$0.35 F_y \leq \del{16,000 \text{ psi}} \underline{24,000 \text{ psi}}$
Helical piles	$0.6 F_y \leq 0.5 F_u$
6. Timber	
	In accordance with the ANSI/AWC NDS

- a. f'_c is the specified compressive strength of the concrete or grout; f_{pc} is the compressive stress on the gross concrete section due to effective prestress forces only; f_y is the specified yield strength of reinforcement; F_y is the specified minimum yield stress of steel; F_u is the specified minimum tensile stress of structural steel.
- b. The stresses specified apply to the gross cross-sectional area within of the concrete surface for precast prestressed piles and to the net cross-sectional area for all other piles. Where a temporary or permanent casing is used, the inside face of the casing shall be considered to be the outer edge of the concrete surface cross-section.

(table excerpt only)

1810.3.3.1.9 Helical Piles

- Calculation of the allowable axial design load, P_a , has been clarified.
- P is the least value of 6 listed items, including base capacity plus helical pile shaft resistance
 - Base capacity = all plate areas x bearing capacity
 - Shaft resistance = shaft area above uppermost plate x ultimate skin resistance



1810.3.6 Deep Foundation Element Splicing

Deep foundation element splices for buildings in Seismic Design Category A and B regions designed by general engineering practices do not have to meet the 50 percent tension and bending capacity requirements.

- Engineered splices in SDC A and B regions not required to meet 50% tension and bending capacity

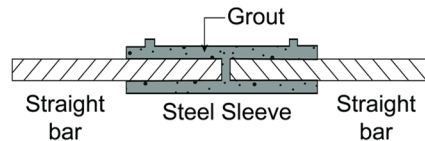

1901.7 Structural Concrete Tolerances (New)

American Concrete Institute standards ACI 117 and ITG-7 have been added to the [IBC](#) by reference to provide acceptable tolerances for concrete construction.

- ACI 117 and ITG 7 added to IBC providing concrete construction tolerances



2205.2.1 Qualified and Prequalified Connections

Beam-column moment connections in Seismic Design Category B and C buildings are now required to be prequalified where the response modification coefficient exception is not applied.

- Beam-column moment connections in special moment frames in SDC B and C require:
 - Prequalification in accordance with AISC 341, Section K1,
 - Qualification by testing in accordance with AISC 341, Section K2, or
 - Prequalification in accordance with AISC 358.

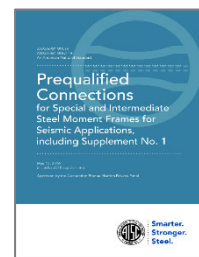

2205.2.1 Qualified and Prequalified Connections (continued)

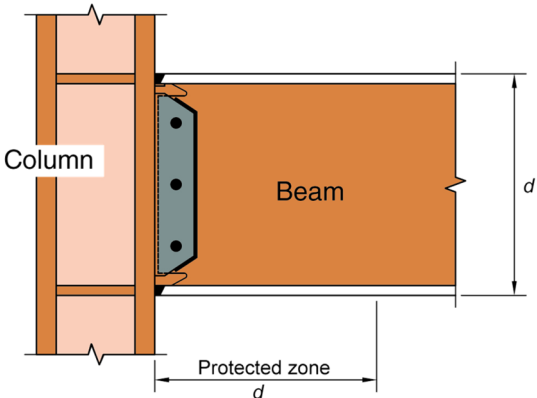
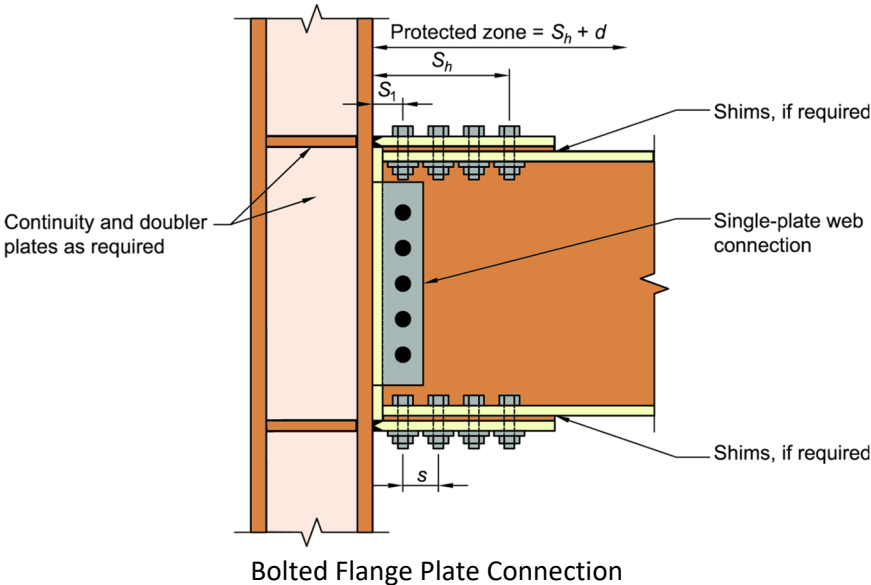

Welded Unreinforced Flange-Welded Web Connection

2303.4.1.2 Wood Truss Bracing

Specific requirements have been added to address wood truss member diagonal bracing and restraint.



Truss Web Member Bracing

Permanent Individual Truss Member Restraint (PITMR)

Permanent Individual Truss Member Diagonal Bracing (PITMDB)

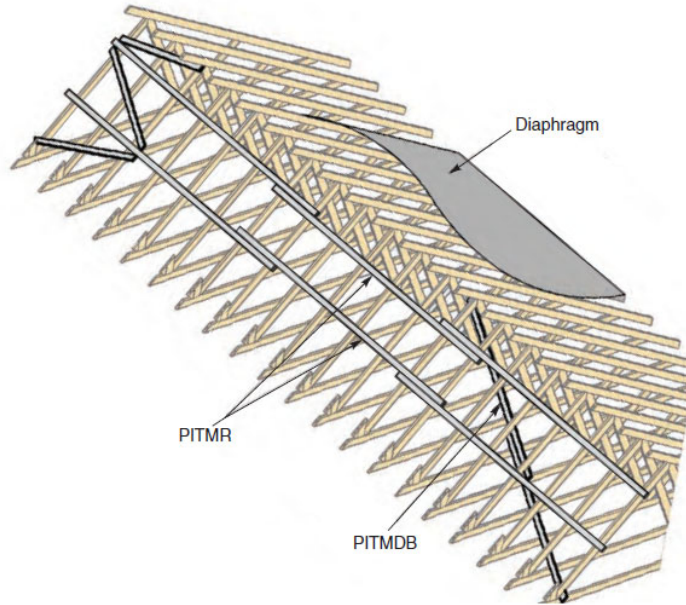

Alternative Bracing Installation

Specific requirements have been added to address wood truss member diagonal bracing and restraint.

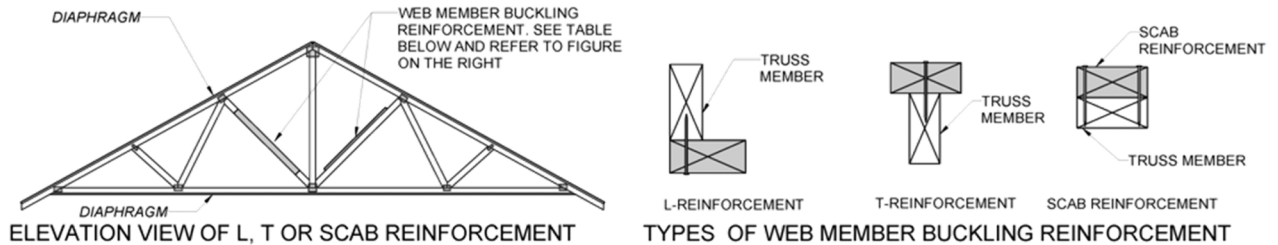

NUMBER OF ROWS OF PITMR SPECIFIED ON WEB MEMBER	SIZE OF TRUSS WEB	TYPE AND SIZE OF WEB REINFORCEMENT ¹ FOR T, L OR SCAB ²	GRADE OF WEB REINFORCEMENT	MINIMUM LENGTH OF WEB REINFORCEMENT	MINIMUM CONNECTION OF WEB REINFORCEMENT TO WEB
ONE	2x4	2x4	Same species and grade or better than web member	90% of web or extend to within 6" of end of web member, whichever is greater	(0.131" x 3") nails at 6" on-center ²
	2x6	2x6			
	2x8	2x8			

¹Maximum allowable web length is 14'

²Attach Scab reinforcement to web with two rows of minimum 0.131" x 3" nails at 6" on-center

Bracing Assumptions

- Compression web lateral force \sim 1-2% axial force
- 4-0.131"x3" nails = 375 lbs with SPF framing
- Top and bottom chords braced by diaphragms
- Design required if no diaphragms present

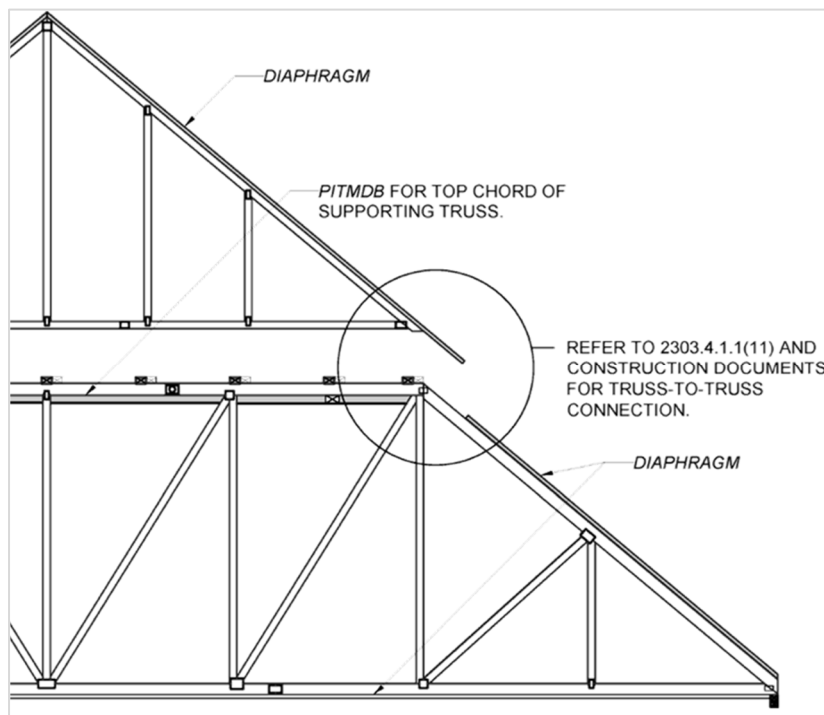
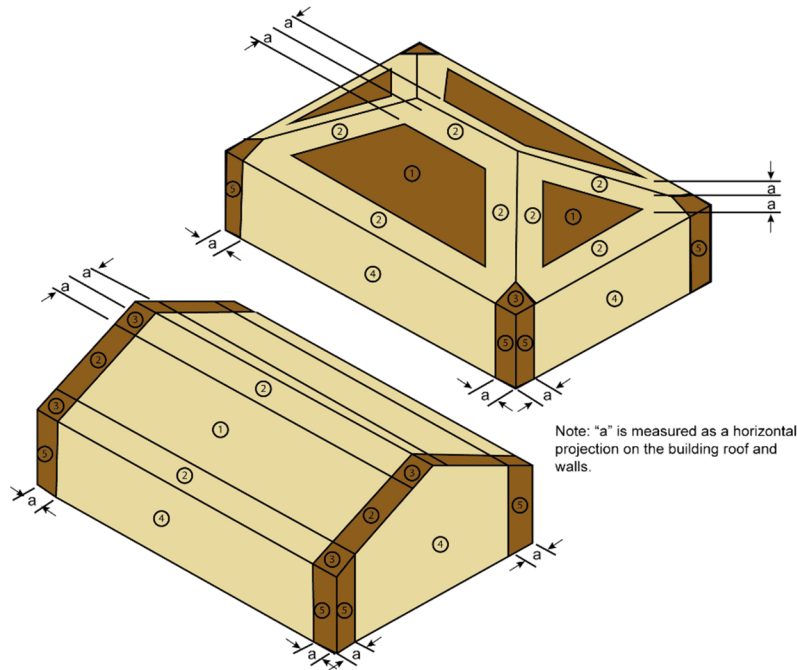

Table 2304.10.2 Sheathing Fasteners

Additional fastener options have been added to the sheathing fastening schedule and nail patterns have been updated to current industry standards and the new ASCE 7 wind loads.

- Formerly Table 2304.10.1
- Additional fastener options added for sheathing fastening schedules
- Nail patterns updated to
 - Current industry standards
 - New ASCE 7 wind loads



Description of Building Elements	Number and Type of Fastener ^a	Spacing and Location	
Wood structural panels (WSP), subfloor, roof and interior wall sheathing to framing and particleboard wall sheathing to framing ^a			
		Edges (inches)	Intermediate supports (inches)
30. $\frac{3}{8}$ " - $\frac{1}{2}$ "	6d common or deformed ($2" \times 0.113"$) or $2\frac{3}{8}" \times 0.113"$ nail (subfloor and wall)	6	12
	8d common or deformed ($2\frac{1}{2}" \times 0.131" \times 0.281"$ head) (roof) or RSRS-01 ($2\frac{3}{8}" \times 0.113"$) nail (roof) ^d	6 ^a	42 ^g
	$2\frac{3}{8}" \times 0.113" \times 0.266"$ head nail (roof)	4 ^f	8 ^f
	$1\frac{3}{4}"$ 16 gage staple, $\frac{7}{16}"$ crown (subfloor and wall)	4	8
	$1\frac{3}{4}"$ 16 gage staple, $\frac{7}{16}"$ crown (roof)	3 ^f	6 ^f
31. $\frac{19}{32}"$ - $\frac{3}{4}"$	8d common ($2\frac{1}{2}" \times 0.131"$); or 6d deformed ($2" \times 0.113"$) (subfloor and wall)	6	12
	8d common or deformed ($2\frac{1}{2}" \times 0.131" \times 0.281"$ head) (roof) or RSRS-01 ($2\frac{3}{8}" \times 0.113"$) nail (roof) ^d	6 ^a	42 ^g
	$2\frac{3}{8}" \times 0.113" \times 0.266"$ head nail; or 2" 16 gage staple, $\frac{7}{16}"$ crown	4	8

(no changes to footnotes a-d)

e. Tabulated fastener requirements apply where the ultimate design wind speed is less than 140 mph. For wood structural panel roof sheathing attached to gable-end roof framing and to intermediate supports within 48 inches of roof edges and ridges, nails shall be spaced at 4 inches on center where the ultimate design wind speed is greater than 130 mph in Exposure B or greater than 110 mph in Exposure C. Spacing exceeding 6 inches on center at intermediate supports shall be permitted where the fastening is designed per the AWC NDS.

f. Fastening is only permitted where the ultimate design wind speed is less than or equal to 110 mph.

g. Nails and staples are carbon steel meeting the specifications of ASTM F1667. Connections using nails and staples of other materials, such as stainless steel, shall be designed by acceptable engineering practice or approved under Section 104.11.

2304.11 Concealed Spaces in Type IV-HT

Concealed spaces are now permitted in floors and roof decks for Type IV-HT.

- Floors
- Roof decks
- Type IV-HT (Section 602.4.4.3)



Table 2308.7.3.1 Rafter Tie Connections

Rafter tie connection requirements have been updated to reflect current standards.

- Rafter tie connection requirements updated
- Reflect current standards

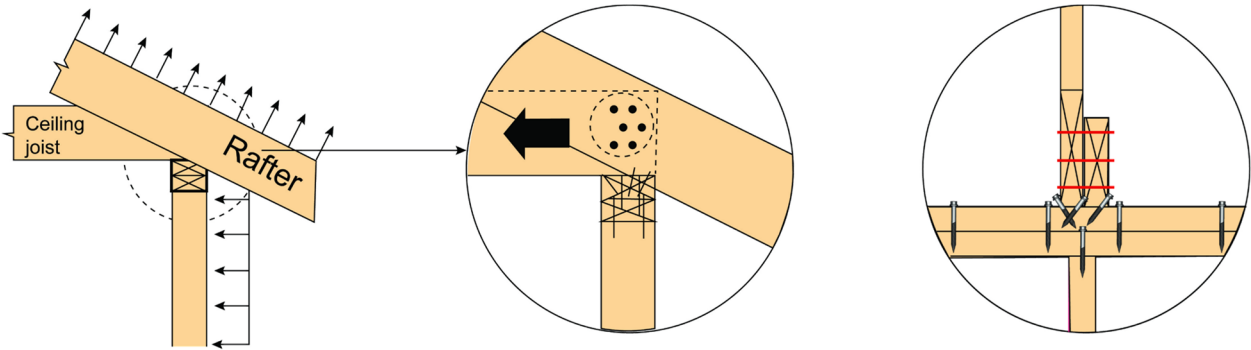

TABLE 2308.7.3.1 Rafter Tie Connections^{g1}

Rafter Slope	Tie Spacing (inches)	Ground Snow Load								
		Live Load Only ^g			30 psf			50 psf		
		Roof span (ft)								
		12	24	36	12	24	36	12	24	36
Required number of 16d common (3½" × 0.162") nails per connection ^{a, b, c, d, e, f, h}										
3:12	12	3	5	8	3	6	9	5	9	13
	16	4	7	10	4	8	12	6	12	17
	19.2	4	8	12	5	10	14	7	14	21
	24	5	10	15	6	12	18	9	17	26
	32	7	13	20	8	16	24	12	23	34
	48	10	20	29	12	24	35	17	34	51

2510.6 Water-Resistive Barriers for Stucco

Water-resistive barrier requirements for stucco have been divided into two categories based on whether the building is in a dry or moist climate.

- Water-resistive barrier requirements for stucco applied over wood-based sheathing have been divided into two categories based on whether the building is in a dry or moist climate.

Two-Layer System

- Each layer of water-resistive barrier is individually installed in a ship lapped fashion
- Interior layer forms continuous drainage plane and is integrated with flashing
- Interior layer represented by solid green line. Exterior layer represented by dashed red line.

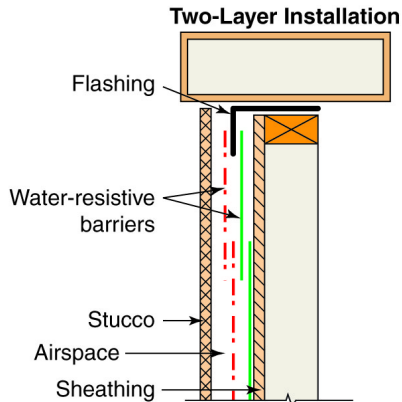

3001.2 Emergency Elevator Communication Systems

- Clarifies provisions for 2-way communication features for accessible elevators
- System to provide both visible text and audible modes, and
 - When operating in each mode, allows for back-and-forth conversation between elevator occupants and emergency personnel
 - Is operational when elevator is operational
 - Allows occupants to select either text-based or audible mode depending on needs.

3005.4 Machine and Control Rooms, Control Spaces, and Machinery Spaces



- This change correlates the VCC with IBC requirements for fire service access elevators.
- The provisions now exclude fire service access elevators (FSAEs) and occupant evacuation elevators (OEEs) from the exceptions for fire protection in the space or room. Each type of elevator is intended to remain running throughout a fire event.

3006.1 Elevator Lobbies and Hoistway Opening Protection



- This revision corrects several broken links that were present due to an existing Virginia amendment deleting the section in its entirety.



3008.1 General (Occupant Evacuation Elevators)



- Eliminates the conflict in the 2018 VCC.
- This change fixes a conflict that we have been aware of for some time. We said we'd fix it – and here it is. This change correlates the VCC with IBC section 3008.1.1 for the purpose of determining the number of available occupant evacuation elevators that are required, based on egress analysis.
- Virginia's 420 ft threshold for these types of elevators remains.

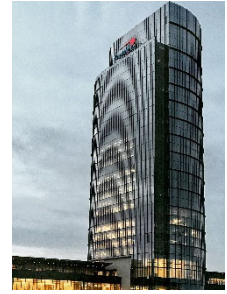

3103.1 Special Event Structures

Special event structures, newly defined in Section 202, are now included in the types of temporary structures that are regulated by both the International Building Code (IBC) and the International Fire Code (IFC).

- Special event structures are now regulated by 3103.
- Such structures, defined in the 2018 IFC, are now similarly defined in the VCC.
 - **SPECIAL EVENT STRUCTURE.** Any ground-supported structure, platform, stage, stage scaffolding or rigging, canopy, tower or similar structure supporting entertainment-related equipment or signage.
- Key criteria addressed include:
 - code conformance for structural strength,
 - fire safety,
 - means of egress accessibility,
 - light,
 - ventilation and
 - sanitary requirements.
- Must also comply with technical provisions of IFC

3114 Public Use Restrooms in Flood Hazard Areas (New)

Special criteria to be applied where public-use restrooms are located within designated flood hazard areas of publicly owned lands have been established to allow such restrooms to be at-grade or above-grade but below the base flood elevation.

- Special criteria is now applied to public-use restrooms located within flood hazard areas of publicly owned lands to allow such facilities to be constructed below the base flood elevation.
- Such restrooms to comply with all requirements of ASCE 24, except elevation requirements.
- Compliance with additional criteria also required, including:
 - Maximum building footprint of 1,500 ft²
 - Constructed of flood-damage-resistant materials
 - All walls to have flood openings
 - Approved emergency plan specifying implementation of protection measures prior to onset of flooding



3115 Intermodal Shipping Containers (New)

The use of intermodal shipping containers as buildings and structures is now recognized in the IBC, and criteria have been established to address the minimum safety requirements without duplicating existing code provisions.

INTERMODAL SHIPPING CONTAINERS. A six-sided steel unit originally constructed as a general cargo container used for the transport of goods and materials.

- Use of intermodal shipping containers as buildings and structures now addressed.
- Previously, approval based on 106.3 Issuance of Modifications; and 112.2 Alternate Methods or Materials
 - ICC G5-2019 Guideline for the Safe Use of ISO Intermodal Shipping Containers Repurposed as Buildings and Building Components
 - Evaluation Reports
- Provisions intended to supplement existing applicable IBC requirements, including:
 - Inspection by approved agency
 - Verification of data plate
 - Method of structural design (detailed design procedure or simplified method for single-units)
- Three ISO reference standards relevant to construction of intermodal shipping containers have been added to Chapter 35.
- New provisions intended to eliminate need for patchwork of potentially conflicting or duplicative requirements.



3302.4 Separations Between Construction Areas



This change clarifies Chapter 33 Fire Safety During Construction by relocating construction provisions from the SFPC, and improves correlation with the SFPC and VEBC. Sections 3309.3 and 3309.4 are relocating the deleted construction sections from the SFPC. Section 3312.1 now correctly references 116.1.1 for temporary occupancy. Section 3313.1 is revised with 2021 language and references the SFPC for fire flow requirements. 2018 sections 3313.2 through 3313.5 are deleted, and are now in the SFPC.

- Part of effort to better correlate with SFPC and VEBC
- Relocates construction requirements from SFPC

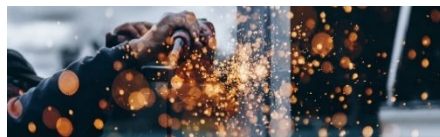

2021 Virginia Energy Conservation Code – Commercial Provisions

2021 IECC Referenced

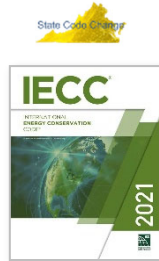
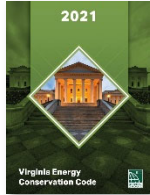

C202 Definitions

New Definitions Relating to On-Site Renewable Energy

- The definition for biomass sources is limited to those that meet specifications as waste products, as defined in the glossary of the Energy Information Administration. There are many types of biomass energy and this definition ensures that virgin material of unknown origin is not used as a steady source of energy. Collectively, these new and revised definitions support the provisions in Section C406 for on-site renewable energy.
- BIOGAS. A mixture of hydrocarbons that is a gas at 60°F (15.5°C) and 1 atmosphere of pressure that is produced through the anaerobic digestion of organic matter.
- BIOMASS. Nonfossilized and biodegradable organic material originating from plants, animals and/or microorganisms, including products, by-products, residues and waste from agriculture, forestry and related industries as well as the nonfossilized and biodegradable organic fractions of industrial and municipal wastes, including gases and liquids recovered from the decomposition of nonfossilized and biodegradable organic material.



New Definitions Relating to Fan Efficiencies

- FAN ARRAY. Multiple fans in parallel between two plenum sections in an air distribution system.
- FAN, EMBEDDED. A fan that is part of a manufactured assembly where the assembly includes functions other than air movement.
- FAN ENERGY INDEX (FEI). The ratio of the electric input power of a reference fan to the electric input power of the actual fan as calculated in accordance with AMCA 208.
- FAN NAMEPLATE ELECTRICAL INPUT POWER. The nominal electrical input power rating stamped on a fan assembly nameplate.
- FAN SYSTEM ELECTRICAL INPUT POWER. The sum of the fan electrical power of all fans that are required to operate at fan system design conditions to supply air from the heating or cooling source to the conditioned spaces and/or return it to the source or exhaust it to the outdoors.



Chapter 3 [CE] General Requirements

301 Climate Zones

- Climate zones updated
- Virginia now has 2 new climate zones in addition to 4A:
 - 3A: 19 localities in southeastern VA
 - 5A: 5 localities centered on Bath Co.
- Implications for envelope, mechanical requirements

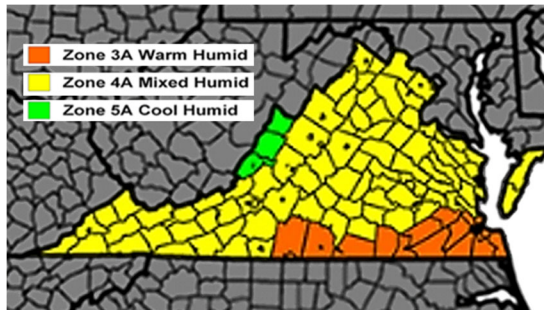

Chapter 4 [CE] Commercial Energy Efficiency

Ch 4 Reformatted for Improved Useability

The “mandatory” and “prescriptive” labels have been removed throughout chapter 4. Instead, this info is consolidated into tables.

- Total Building Performance

Compliance Paths - C401.2 Application

- Compliance path options are named, and the sections required for each option are outlined.
 - Prescriptive Compliance
 - C407 Total Building Performance
 - ASHRAE 90.1
- No technical changes are intended. The intent is strictly to make the VECC more understandable, and easier to use.

C401.2 Application. Commercial buildings shall comply with Section C401.2.1 or C401.2.2.

C401.2.1 International Energy Conservation Code. Commercial buildings shall comply with one of the following:

1. **Prescriptive Compliance.** The Prescriptive Compliance option requires compliance with Sections C402 through C406 and Section C408. Dwelling units and sleeping units in Group R-2 buildings without systems serving multiple units shall be deemed to be in compliance with this chapter, provided that they comply with Section R406.
2. **Total Building Performance.** The Total Building Performance option requires compliance with Section C407.

Exception: Additions, alterations, repairs and changes of occupancy to existing buildings complying with Chapter 5.

C401.2.2 ASHRAE 90.1. Commercial buildings shall comply with the requirements of ANSI/ASHRAE/IESNA 90.1.

Compliance Paths

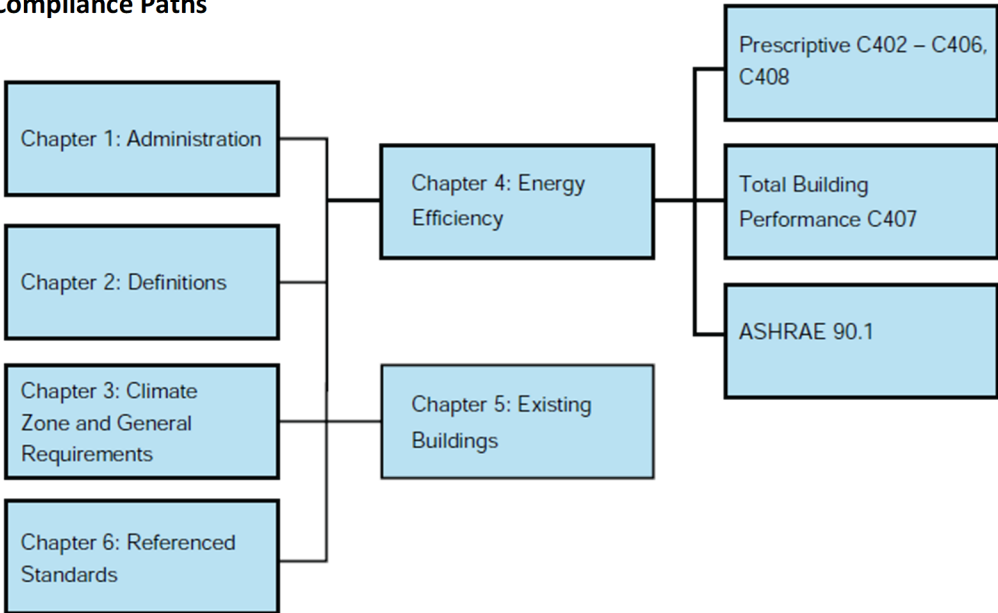

C401.3 Envelope Certificate (New)

The new language provides for a permanent certificate for commercial buildings that will record basic information related to the building’s thermal envelope. This will complement the information required in Section C408 related to the documentation of mechanical and lighting systems.

- Permanent thermal envelope certificate
 - R-values of insulation
 - U-factors and SHGCs of fenestration
 - Envelope air leakage test results
- Completed by approved party
 - Posted in approved location and copy included in construction files for project

Energy Efficiency Certificate			
Code edition	<input type="text"/>		
Compliance path	<input type="text"/>		
Insulation Rating	R -Value		R -Value
Ceiling/Roof	R-		R-
Walls	Frame	R-	Mass R-
	Basement	R-	Crawl space R-
Floors	Over unconditioned space	R-	Slab edge R-
Ducts	Attic	R-	Other R-
Air Leakage Test Results			
Envelope testing	ACH	Pa.	Duct testing cfm/100 ft ²
Fenestration Rating	NFRC U-Factor		NFRC SHGC
Window	U-		
Opaque door	U-		
Skylight	U-		
Weighted average	U-		
Designer/builder	<input type="text"/>		Date <input type="text"/>
This Certificate is to be posted in accordance with Section C401.3 of the International Energy Conservation Code.			

Sample thermal envelope certificate.



C402.1.1, C402.1.1.1 Building Envelope

- New envelope requirements for greenhouses that are mechanically heated or cooled
- Low-energy use greenhouse structures are still exempt if they have a low energy usage per square foot in line with C402.1.1

Table C402.1.3 Minimum R –Values; Table C402.1.4 U-Factor Method

The minimum R-Values in Table C402.1.3 are increased to improve the efficiency of the building envelope and to align with ASHRAE 90.1.

TABLE C402.1.3 Opaque Thermal Envelope Insulation Component Requirements, R-Value Method^a

CLIMATE ZONE	3		4		5	
	All other	Group R	All other	Group R	All other	Group R
Roofs						
Insulation entirely above roof deck	R-25ci	R-25ci	R-30ci	R-30ci	R-30ci	R-30ci
Metal buildings^b	<u>R-19 +</u> <u>R-11 LS</u>	<u>R-19 +</u> <u>R-11 LS</u>	<u>R-19 +</u> <u>R-11 LS</u>	<u>R-19 +</u> <u>R-11 LS</u>	<u>R-19 +</u> <u>R-11 LS</u>	<u>R-19 +</u> <u>R-11 LS</u>
Attic and other	<u>R-38</u>	<u>R-38</u>	<u>R-49</u>	<u>R-49</u>	<u>R-49</u>	<u>R-49</u>
Walls, above grade						
Mass^f	R-7.6ci	R-9.5ci	R-9.5ci	R-11.4ci	R-11.4ci	R-13.3ci
Metal building	<u>R-13 +</u> <u>R-6.5ci</u>	<u>R-13 +</u> <u>R-13ci</u>	<u>R-13 +</u> <u>R-13ci</u>	<u>R-13 +</u> <u>R-14ci</u>	<u>R-13 +</u> <u>R-14ci</u>	<u>R-13 +</u> <u>R-14ci</u>
Metal framed	<u>R-13 +</u> <u>R-7.5ci</u>	<u>R-13 +</u> <u>R-7.5ci</u>	<u>R-13 +</u> <u>R-7.5ci</u>	<u>R-13 +</u> <u>R-7.5ci</u>	<u>R-13 +</u> <u>R-10ci</u>	<u>R-13 +</u> <u>R-10ci</u>
Wood framed and other	<u>R-13 +</u> <u>R-3.8ci or</u> <u>R-20</u>	<u>R-13 +</u> <u>R-3.8ci or</u> <u>R-20</u>	<u>R-13 +</u> <u>R-3.8ci or</u> <u>R-20</u>	<u>R-13 +</u> <u>R-3.8ci or</u> <u>R-20</u>	<u>R-13 +</u> <u>R-7.5ci or</u> <u>R20 +</u> <u>R3.8ci</u>	<u>R-13 +</u> <u>R-7.5ci or</u> <u>R20 +</u> <u>R3.8ci</u>
Walls, below grade						
Below-grade wall^d	<u>NR</u>	<u>NR</u>	<u>R-7.5ci</u>	<u>R-10ci</u>	<u>R-7.5ci</u>	<u>R-10ci</u>
Floors						
Mass^e	<u>R-10ci</u>	<u>R-10ci</u>	<u>R-14.6ci</u>	<u>R-16.7ci</u>	<u>R-14.6ci</u>	<u>R-16.7ci</u>
Joist/framing	<u>R-30</u>	<u>R-30</u>	<u>R-30</u>	<u>R-30</u>	<u>R-30</u>	<u>R-30</u>
Slab-on-grade floors						
Unheated slabs	<u>NR</u>	<u>R-10 for</u> <u>24" below</u>	<u>R-15 for</u> <u>24" below</u>	<u>R-15 for</u> <u>24" below</u>	<u>R-15 for</u> <u>24" below</u>	<u>R-20 for</u> <u>24" below</u>
Heated slabs^g	R-10 for 24" below + R-5 full slab	R-10 for 24" below + R-5 full slab	R-15 for 24" below + R-5 full slab	R-15 for 24" below + R-5 full slab	R-15 for 36" below + R-5 full slab	R-15 for 36" below + R-5 full slab

- Assembly descriptions can be found in ANSI/ASHRAE/IESNA 90.1 Appendix A.
- Where using R-value compliance method, a thermal spacer block shall be provided, otherwise use the U-factor compliance method in Table C402.1.4.
- [not applicable in climate zones 3, 4, or 5]
- Where heated slabs are below grade, below-grade walls shall comply with the exterior insulation requirements for heated slabs.
- "Mass floors" shall be in accordance with Section C402.2.3.
- "Mass walls" shall be in accordance with Section C402.2.2.
- The first value is for perimeter insulation and the second value is for full, under-slab insulation. Perimeter insulation is not required to extend below the bottom of the slab

Table C402.1.4, C402.1.4 Insulation and Fenestration U -Factor Criteria

- The assembly U-factors for many roof, wall and floor assemblies have been decreased in Climate Zones 4 through 8 to align with the values in ASHRAE 90.1.
- Footnotes have been revised.

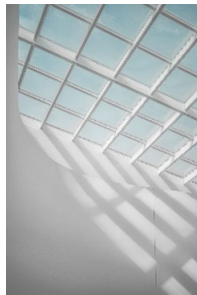

Table C402.4 U-Factor and SHGC Requirements, Table C402.4.3 SHGC Adjustment Multipliers



This change improves and simplifies the Virginia Energy Conservation Code by eliminating state-specific amendments that are either already incorporated in the 2021 IECC or are no longer necessary.

C402.4 U -Factor and SHGC Requirements

- Changes to the U-factor and SHGC requirements increase the energy efficiency of windows, doors and skylights
- Table is revised to classify SHGC on the operable/fixed properties of the fenestration rather than orientation

TABLE C402.4 Building Envelope Fenestration Maximum U-Factor and SHGC Requirements

CLIMATE ZONE	3		4		5	
	Vertical Fenestration					
U-factor	0.46 <u>0.42</u>		0.38 <u>0.36</u>		0.38 <u>0.36</u>	
Fixed fenestration	0.46 <u>0.42</u>		0.38 <u>0.36</u>		0.38 <u>0.36</u>	
Operable fenestration	0.60 0.54		0.45		0.45	
Entrance doors	0.77 <u>0.68</u>		0.77 <u>0.63</u>		0.77 <u>0.63</u>	
SHGC						
Orientation ^a	SEW	N	SEW	N	SEW	N
PF < 0.2	0.25	0.33	0.36	0.48	0.38	0.51
0.2 ≥ PF < 0.5	0.30	0.37	0.43	0.53	0.46	0.56
PF ≤ 0.5	0.40	0.40	0.58	0.58	0.61	0.61
Skylights						
U-Factor	0.55		0.50		0.50	
SHGC	0.35 <u>0.30</u>		0.40		0.40	

NR = No Requirement, PF = Projection Factor

- “N” indicates vertical fenestration oriented within 45 degrees of true north. “SEW” indicates orientations other than “N”. For buildings in the southern hemisphere, reverse north and south. Buildings located at less than 23.5 degrees latitude shall use SEW for all orientations.

C402.5 Air Leakage

Air leakage requirements are expanded to include requirements for residential and nonresidential air leakage testing and for building envelope performance verification for buildings not tested.

- Dwelling unit testing is required for Group R and I occupancies
- Building envelope testing is required for occupancies other than Group R and I
- Buildings exempt from testing
 - Material or assembly
 - Performance verification



C402.5 Air leakage—thermal envelope. The building thermal envelope shall comply with Sections C402.5.1 through Section C402.5.11.1, or the building thermal envelope shall be tested in accordance with Section C402.5.2 or C402.5.3. Where compliance is based on such testing, the building shall also comply with Sections C402.5.7, C402.5.8 and C402.5.9.

- Air intakes, exhaust openings, stairways and shafts
- Loading dock weather seals
- Vestibules

This language picks up section C402.5.1.2 Air Barrier Compliance. Requires testing.

- Note that this is the charging language for air leakage testing.
- Stairway enclosures, elevator shaft vents and other outdoor air intakes and exhaust must have dampers
- Loading door openings must have weather seals
- Building entrances must have an enclosed vestibule – with 7 exceptions

Air Barrier Testing for Group I and R - C402.5.1.2, C402.5.2

Where multiple dwelling/sleeping units or other occupiable conditioned spaces are contained within one building thermal envelope, each unit must be tested separately with an unguarded blower door test

- Building air leakage is the weighted average of all testing unit results, weighted by each testing unit's enclosure area
- In buildings with fewer than 8 units, each unit must be tested
- In buildings with 8 or more units, sampling is permitted. The sampling requires a minimum of 7 units or 20% of all units, whichever is greater.
 - Top floor unit, ground floor unit, unit with largest area
 - For each unit that exceeds max. air leakage rate, two additional units must be tested.

Air Barrier Testing for All Other Occupancies - C402.5.1.2, C402.5.3

Buildings or portions thereof other than Groups R and I must be tested using the building thermal envelope testing method

- Exception: Buildings between 5,000 ft² and 50,000 ft² in Climate Zone 3A
- Tested per ASTM E779, ANSI/RESNET/ICC 380, ASTM E3158 or ASTM E1827 or equivalent method
- Leakage limited to 0.40 cfm/ft² of building thermal envelope area at 75 Pa
- Alternatively, portions of the building can be tested and measured air leakage area weighted
 - Entire envelope area of all stories that have any spaces directly under a roof
 - Entire envelope area of all stories that have a building entrance, exposed floor, or loading dock, or are below grade
 - Representative above-grade sections of the building totaling at least 25 percent of the wall area enclosing the remaining conditioned space
- If the building air leakage rate is over 0.40 cfm/ft² but not greater than 0.60 cfm/ft²:
 - Diagnostic evaluation using smoke tracer or infrared imaging while building is pressurized required along with a visual inspection of the air barrier
 - Any leaks noted must be sealed where such sealing can be made without destruction of existing building components
 - A report identifying corrective actions taken to seal leaks must be submitted to the code official and building owner
 - Building is deemed to comply, no retest required

Two different methods of testing for these buildings:

- The first allows a whole building test to be used when it demonstrates the air leakage of the whole building is at or below the target air leakage rate.
- Second approach allows for sampling different areas of the building and showing that the air leakage complies on an area weighted basis. When using this alternative, certain areas need to be included in the test.

C402.5.11 Operable Openings Interlocking

Large, operable openings (>40 ft²) such as roll-up doors and windows must now be interlocked with the heating and cooling system. The exceptions address very specific situations where this requirement would hinder the function of the space, such as separately zoned areas where food preparation areas contribute to the HVAC loads, warehouse doors and entrance doors that are part of a vestibule system.

- Time and temperature specific
 - System adjustments within 10 min. of opening operable opening
 - Controls raise cooling setpoint to 90°F and lower heating setpoint to 55°F
 - Controls shut off the system entirely when outdoor temps are below 90°F or above 55°F
- Exceptions
 - Separately zoned areas associated with the preparation of food that contain appliances that contribute to the HVAC loads of a restaurant or similar type of occupancy
 - Warehouses that utilize overhead doors for the function of the occupancy, where approved by the code official
 - The first entrance doors where located in the exterior wall and are part of a vestibule system



C403.1.2 Mechanical Systems for Data Centers

- Prescriptive requirements for data centers have been replaced with performance based requirements
- Comply with Sections 6 and 8 of ASHRAE 90.4 but must follow mechanical load component tables provided in VECC C403.1.2

CLIMATE ZONE	DESIGN MLC AT 100% AND AT 50% ITE LOAD
0A	0.24
0B	0.26
1A	0.23
2A	0.24
3A	0.23
4A	0.23
5A	0.22
6A	0.22
1B	0.28
2B	0.27
3B	0.26
4B	0.23
5B	0.23

CLIMATE ZONE	HVAC MAXIMUM ANNUALIZED MLC AT 100% AND AT 50% ITE LOAD
0A	0.19
0B	0.20
1A	0.18
2A	0.19
3A	0.18
4A	0.17
5A	0.17
6A	0.17
1B	0.16
2B	0.18
3B	0.18
4B	0.18
5B	0.16

C403.4.2.3 Automatic Start and Stop

- HVAC systems with direct digital controls serving individual zones must have automatic stop controls.
- The controls must be capable of decreasing the heating temperature setpoint by 2°F and increasing the cooling setpoint by 2°F for some time period before the scheduled unoccupied period where the temperature can drift within the comfort range using the adjusted setpoints.
- Typically, this results in little heating or cooling for 30 to 60 minutes at the end of the occupied period.



C403.8.3 Fan Efficiency

The fan efficiency metric is updated to the Fan Energy Index, providing consistent fan efficiency requirements across the IECC and ASHRAE 90.1 and resulting in a more effective energy savings metric.

- Fan Energy Index (FEI) replaces Fan Efficiency Grade (FEG) metric
 - Includes losses of motors and drives if sold with fan; otherwise, FEI ratings for bare fan include default motor/drive losses
- FEI > 1.00 for covered fans
 - AMCA 208
 - Ratings from approved third-party lab and labeled
- Sizing/selection window eliminated
 - “15 percentage points from peak total efficiency” was difficult to enforce
- Other changes to C403.8.3 Fan efficiency
 - Exemption removed for powered roof ventilators (PRVs)
 - Refined exemptions for fans sold (embedded) within packages
 - Lower-size limit reduced from 5 HP to 1 HP

C403.8.5 Low-Capacity Ventilation Fans (New)

Requirements for low-capacity ventilation fans apply the efficiencies of ventilation fans typical of residential construction to mid-rise residential occupancies and small commercial buildings

- Except when part of listed HVAC appliance
- Except dryer exhaust, range hood main or booster fans



TABLE C403.8.5 Low-Capacity Ventilation Fan Efficacy^a

FAN LOCATION	AIRFLOW RATE MINIMUM (CFM)	MINIMUM EFFICACY (CFM/WATT)	AIRFLOW RATE MAXIMUM (CFM)
HRV or ERV	Any	1.2 cfm/watt	Any
In-line fan	Any	3.8 cfm/watt	Any
Bathroom, utility room	10	2.8 cfm/watt	< 90
Bathroom, utility room	90	3.5 cfm/watt	Any

C405.2.8 Parking Garage Lighting Control (New)

Lighting within 30 feet of the perimeter opening or fenestration must reduce in response to daylight by at least 50%.

Parking garages also have daylight transition zones at entrances and exits, there is actually a lot more lighting there than in the rest of the garage to help drivers' eyes adapt to the daylight as they leave.

At night, there could be too much light into the drivers' eyes so the requirement here is that at night, the lighting is dimmed down in the daylight transition zone to make it easier on their eyes.



- Occupant sensor or time-switch control required
- Lighting power of luminaires automatically reduced by at least 30% when there is no activity within a lighting zone for 20 minutes
- Lighting zones not larger than 3,600 ft²
- Perimeter daylight responsive controls



C405.4 Lighting for Plant Growth (New)

- At least 95% of permanently installed luminaires used for plant growth and maintenance must have a photon efficiency of not less than 1.6 $\mu\text{mol}/\text{J}$
- ANSI/ASABE S640
- Farm exemption may apply; consult your building official.

C405.11 Automatic Receptacle Control (New)

- 50% of all 125 V, 15- and 20-amp receptacles installed in enclosed offices, conference rooms, rooms used primarily for copy or print functions, breakrooms, classrooms and individual workstations must have automatic receptacle control.
- 25% of branch circuit feeders for modular furniture not shown on construction documents to have automatic control.
- Multiple ways to meet this:
 - Scheduled basis using time of day, but that's limited to 5000 sq ft or a single floor
 - Occupancy sensor that turns off within 20 minutes of all occupants leaving
 - An automated signal from another control or alarm system that turns off within 20 minutes



LOAD CATEGORY	DESCRIPTION OF ENERGY USE
Total HVAC system	Heating, cooling and ventilation, including but not limited to fans, pumps, boilers, chillers and water heating. Energy used by 120-volt equipment, or by 208/120-volt equipment that is located in a building where the main service is 480/277-volt power, is permitted to be excluded from total HVAC system energy use.
Interior lighting	Lighting systems located within the building.
Exterior lighting	Lighting systems located on the building site but not within the building.
Plug loads	Devices, appliances and equipment connected to convenience receptacle outlets.
Process load	Any single load that is not included in an HVAC, lighting or plug load category and that exceeds 5 percent of the peak connected load of the whole building, including but not limited to data centers, manufacturing equipment and commercial kitchens.
Building operations and other miscellaneous loads	The remaining loads not included elsewhere in this table, including but not limited to vertical transportation systems, automatic doors, motorized shading systems, ornamental fountains, ornamental fireplaces, swimming pools, in-ground spas and snow-melt systems.

C405.12 Energy Monitoring

- Applies to new buildings 25,000 ft² or larger
- Must be equipped to measure, monitor, record and report energy consumption data
- Exception: R-2 occupancies and individual tenant spaces if the space has its own utility services and meters and has less than 5,000 ft² of conditioned floor area

C406 Additional Efficiency Requirements

When complying with the Prescriptive Compliance option, designers may select from 11 points-based additional energy efficiency options that now consider climate zone and occupancy type.

- Required for prescriptive compliance
- Structure revised
 - Points-based
 - 10 points (credits) required
 - 1 point equivalent to 0.25% energy savings
 - Equity of efficiency options across climate zones
- Expanded options
 - 11 options total, 3 new

SECTION	CLIMATE ZONE		
	3A	4A	5A
C406.2.1: 5% heating efficiency improvement	NA	NA	1
C406.2.2: 5% cooling efficiency improvement	4	3	2
C406.2.3: 10% heating efficiency improvement	NA	NA	2
C406.2.4: 10% cooling efficiency improvement	7	5	4
C406.3: Reduced lighting power	9	8	7
C406.4: Enhanced digital lighting controls	2	2	2
C406.5: On-site renewable energy	9	9	9
C406.6: Dedicated outdoor air	4	5	5
C406.7.2: Recovered or renewable water heating	NA	NA	NA
C406.7.3: Efficient fossil fuel water heater	NA	NA	NA
C406.7.4: Heat pump water heater	NA	NA	NA
C406.8: Enhanced envelope performance	4	7	10
C406.9: Reduced air infiltration	4	8	11
C406.10: Energy monitoring	3	3	2
C406.11: Fault detection and diagnostics system	1	1	1

Example: Table C406.1(1)

Additional Energy Efficiency Credit Options

When complying with the Prescriptive Compliance option, designers may select from 11 points-based additional energy efficiency options that now consider climate zone and occupancy type.

1. More efficient HVAC performance
2. Reduced lighting power
3. Enhanced lighting controls
4. On-site supply of renewable energy
5. Dedicated outdoor air systems
6. High-efficiency service water heating
7. Enhanced envelope performance
8. Reduced air infiltration
9. Energy monitoring system
10. Fault detection and diagnostics
11. Efficient kitchen equipment



2021 Virginia Existing Building Code



2021 Virginia Existing Building Code

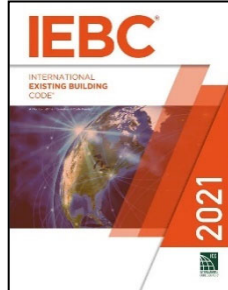
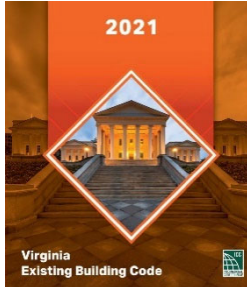

102.2.1, 103.2 Change of Occupancy; Group I-2 or I-3 Applicability



Clarifies when to use the VEBC and when to use the VCC for:

- Groups I-2 and I-3
- Permits, inspections, and issuance of certificate of occupancy



102.2.2 Reconstruction, Alteration, or Repair in Group R-5 Occupancies



Adds exception, aligning this section with existing requirement in 302.3

- Must meet UL 217 and require 10-year sealed batteries for battery-only replacements



VEBC section 302.3 requires replacement smoke alarms to meet UL 217 and requires 10-year sealed batteries for battery-only replacements. If the R-5 exception was taken to use the VRC instead of the VEBC, this requirement to have current technology replacement smoke alarms is lost. This change brings application of the VRC to R-5 consistent with use of the VEBC for R-5.

103.9 Construction Documents



- Clarifies which professionals are permitted to prepare any required flood elevation certificate

202 [A] Change of Occupancy



- “Accessibility” removed from the definition
- Aligns with changes to remove accessibility requirements driven by change of occupancy
- Aligns with ADA

Accessibility is no longer a trigger to determine a change of occupancy by itself. This aligns with the language of the ADA, which does not require upgrades based purely on a change of occupancy.

304.3.1 Operational Constraints



- Provides pointer for R-5 occupancies to VRC R310.4.4 Bars, Grilles Covers and Screens



404.3 Alterations Affecting an Area Containing a Primary Function



- Editorial – no technical changes
- Clarifies application of provisions to existing toilet facilities and drinking fountains
- Separates requirements to upgrade toilet facilities and drinking fountains from the requirements to upgrade the accessible route to the primary function area

502.1.1 Structural Concrete



- Adds ACI 562-21 as reference for assessment, design, and repair of existing structural concrete

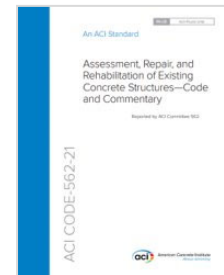

~~603.6 Plumbing Deleted~~



Any occupant load change that increases the number of required plumbing fixtures is a change of occupancy by definition and section 710.1 is applicable. The previous language of section 603.6 was not consistent with the exception to 710.1, and was deleted to prevent confusion.

701.1 and Chapter 14



This group of changes represent a continuation of cleanup regarding the prohibition in use of the Chapter 14 scoring method for change of use in Groups H, I, and R-5

- Chapter 14 has been clarified
- Commentary language has been removed from the text
- Scoping is simplified
- Establishes that evaluation is based on new occupancies
- Addresses partial changes of occupancy

1201.8 Separations Between Construction Areas;

1209.1 When Required (Water Supply in Construction Areas)

New requirements correlate with the SFPC and VCC on fire safety during construction:

- Adds fire safety requirements for such separations
- Adds language specific to vertical combustible construction and installation of standpipe systems to section



~~1201.7 Facilities Required Deleted~~

Deletes requirements relating to plumbing facilities available to workers during construction or demolition. Virginia deletes this from the IPC; this change brings the VEBC into alignment.

2020 National Electrical Code (NEC / NFPA 70)

Code Wide Changes

- **Available Fault Current References**
- **Reconditioned Equipment**
- **Definition Statements**
- **Alignment of GFCI requirements**
- **Allowable Ampacity vs. Ampacity**
- **Term “Grounding Conductor” deleted**



Four (4) new articles

<p>Article 242 – Overvoltage Protection (CMP-10)</p>	<p>This article provides the general, installation, and connection requirements for overvoltage protection and overvoltage protective devices. Part II of the article covers surge-protective devices (SPDs) permanently installed on premises wiring systems of not more than 1000 volts, nominal. Part III covers surge arresters permanently installed on premises wiring systems over 1000 volts, nominal.</p>
<p>Article 311 – Medium Voltage Conductors and Cable (CMP-6)</p>	<p>This article will cover the use, installation, construction specifications and ampacities for medium voltage conductors and cable (Type MV). Medium voltage conductor and cable requirements that were previously found in Articles 310 (Conductors or General Use) and 328 (Medium Voltage Cable) were consolidated into one article to improve the usability of the Code.</p>
<p>Article 337 – Type P Cable (CMP-6)</p>	<p>This article covers the use, installation, and construction specifications for up through 2000-volt Type P cable (armored and unarmored). Type P cable is defined as “a factory assembly of one or more insulated flexible tinned copper conductors, with associated equipment grounding conductor(s), with or without a braided metallic armor and with an overall nonmetallic jacket.”</p>
<p>Article 800 - General Requirements for Communication Systems (CMP- 16)</p>	<p>Article 800 (General Requirements for Communications Systems) combines common requirements previously found in Articles 800 (now Article 805) for communications circuits, 820 for community antenna television and radio distribution systems, 830 for network-powered broadband communications systems and 840 for premises-powered broadband communications systems into a new “general” article that applies to all of these articles unless modified by the forenamed articles. This new article will serve as a placeholder for redundant requirements throughout previous Articles 800 (now Article 805), 820, 830, and 840.</p>

Article 100: Definitions - Scope

Change Type: Revision

- Scope of Article 100 is modified to include new Part III for Hazardous (Classified) Locations
- During the 2017 *NEC* revision cycle, several definitions that applied to hazardous (classified) locations were relocated to Article 100 of the *NEC* (Previously located at 500.2 in the 2014 *NEC*)
- Creating new Part III and the relocation of these definitions will add clarity and usability and help users of the *Code* understand that these definitions only apply to hazardous (classified) location articles located in Chapter 5

Article 100: Definitions – Accessible (as applied to equipment)

Change Type: Revision

- **2017 Requirement:** The definition of *Accessible* (as applied to equipment) was defined as “admitting close approach; not guarded by locked doors, elevation, or other effective means.”
- **2020 Requirement:** The definition of *Accessible* (as applied to equipment) now is specified as “**capable of being reached for operation, renewal, and inspection.**”

Article 100: Definitions – Supply-Side Bonding Jumper

Change Type: Relocation

- **2020 Requirement:** The definition for Bonding Jumper, Supply-Side was relocated from 250.2 to Article 100 as the term is used in more than just Article 250.

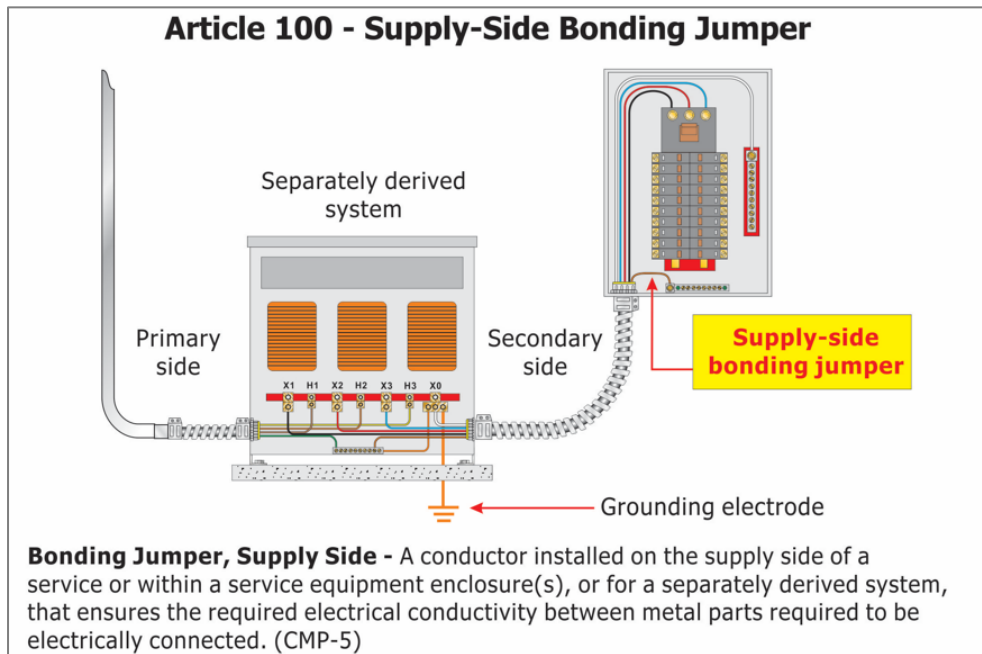

Article 100: Definitions – Equipotential Plane

Change Type: Relocation and Revision

- The previous definition for “Equipotential Plane” in Article 682 (Natural and Artificially Made Bodies of Water) was revised and moved to Article 100.

Equipotential Plane. An area where wire mesh or other conductive elements are on, embedded in, or placed under the walk surface within 75 mm (3 in.), bonded to all metal structures and fixed nonelectrical equipment that may become energized, and connected to the electrical grounding system to prevent a difference in voltage from developing within the plane. **Accessible conductive parts bonded together to reduce voltage gradients in a designated area. (CMP-17)**

Article 100 Definitions: Dormitory Unit

Change Type: New

- The term “dormitory unit” or “dormitories” was used (8) times in (4) different articles in the 2017 NEC and (9) times in the 2020 NEC and was previously undefined.

Dormitory Unit. A building or a space in a building in which group sleeping accommodations are provided for more than 16 persons who are not members of the same family in one room, or a series of closely associated rooms, under joint occupancy and single management, with or without meals, but without individual cooking facilities. (CMP 2)

Article 100 Definitions: Free Air

Change Type: New

- The term “Free Air” was used 22 times throughout the Code but was not defined, so a new definition was added.

Free Air (as applied to conductors). Open or ventilated environment that allows for heat dissipation and air flow around an installed conductor. (CMP-6)

Article 100 Definitions: Fault Current and Available Fault Current

Change Type: New

Fault Current: The current delivered at a point on the system during a short-circuit condition. (CMP-10)

Available Fault Current: The largest amount of current capable of being delivered at a point on the system during a short-circuit condition. (CMP-10)

Informational Note: A short-circuit can occur during abnormal conditions such as a fault between circuit conductors or a ground fault. See Informational Note Figure 100.1.

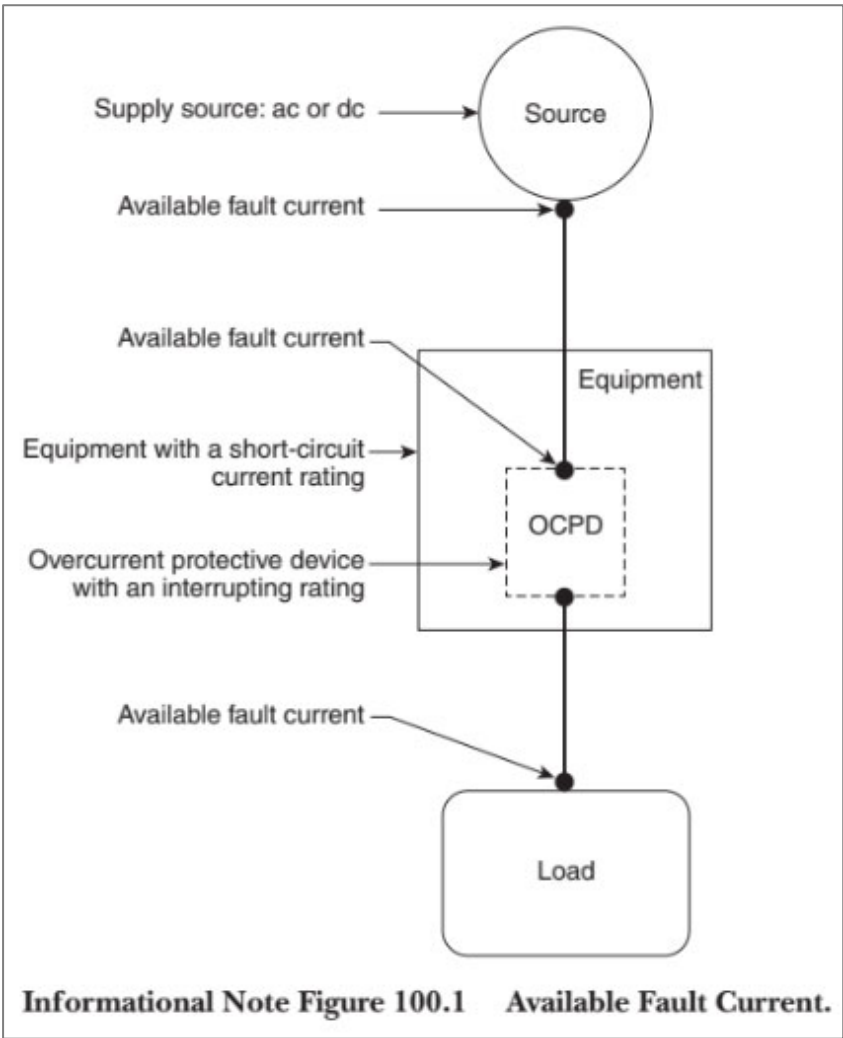

Article 100 Definitions: Habitable Room

Change Type: New

- The terms “nonhabitable room” or “habitable room(s)” appeared eight times in the 2017 NEC however there was no definition of the term.
- This will add clarity and usability to the *Code* for both the installer and AHJ in relation to sections of the *Code* that reference a “habitable room or area”.

Habitable Room. A room in a building for living, sleeping, eating, or cooking, but excluding bathrooms, toilet rooms, closets, hallways, storage or utility spaces, and similar areas. (CMP-2)

Article 100 Definitions: Island Mode

Change Type: New

- A new definition for “Island Mode” primarily related to microgrid systems and stand-alone systems was added to Article 100
- All references to stand-alone (islanded) mode have been changed to island mode and the latter term is now defined in Article 100



Island Mode. The operational mode for standalone power production equipment or an isolated microgrid, or for a multimode inverter or an interconnected microgrid that is disconnected from an electric power production and distribution network or other primary power source. (CMP-4)

Informational Note: Isolated microgrids are distinguished from interconnected microgrids, which are addressed in Article 705.

Article 100 Definitions and 210.15: Reconditioned

Change Type: New

- A new definition for “Reconditioned” was added to Article 100 and an informational note added to indicate that the term reconditioned is frequently referred to as rebuilt, refurbished, or remanufactured.

Reconditioned. Electromechanical systems, equipment, apparatus, or components that are restored to operating conditions. This process differs from normal servicing of equipment that remains within a facility, or replacement of listed equipment on a one-to-one basis. (CMP-10)

Informational Note: The term reconditioned is frequently referred to as rebuilt, refurbished, or remanufactured.

110.22(A) Identification of Disconnecting Means

Change Type: Revision

- In addition to being marked with the purpose of the disconnect, requirements were added to demand the identification of the circuit source that supplies the disconnecting means (other than one- or two-family dwellings).

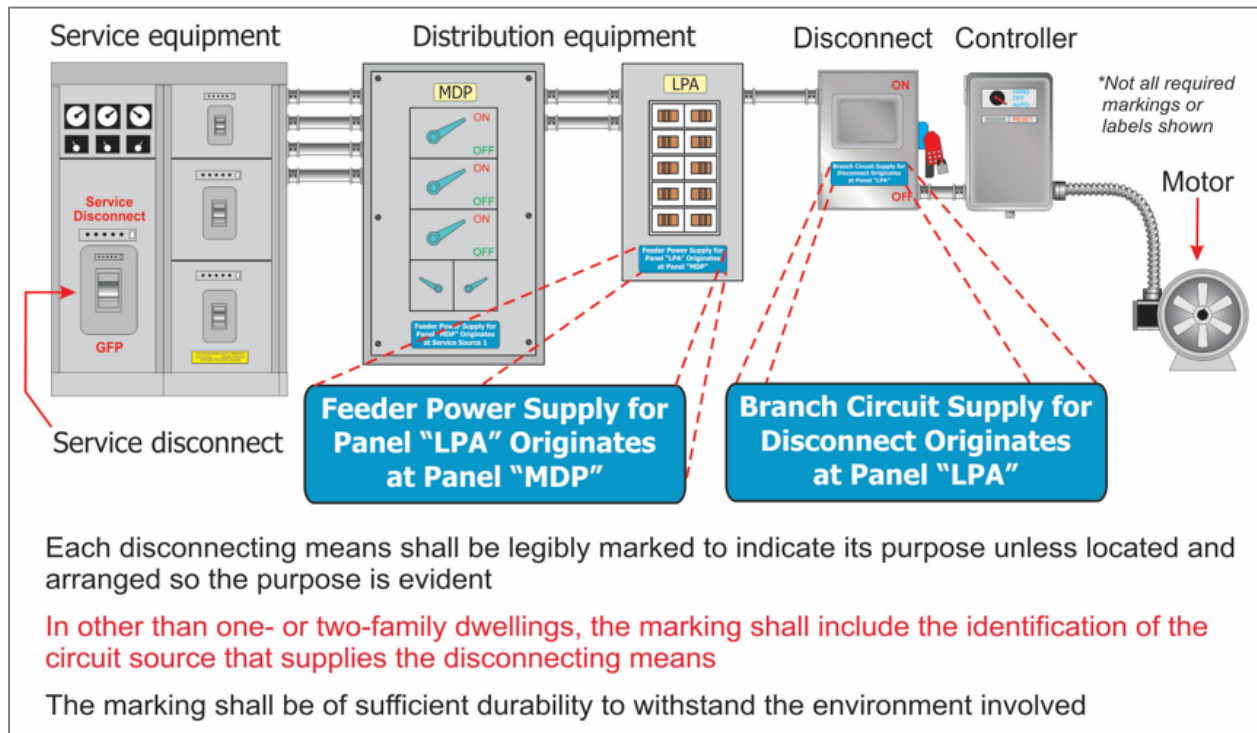

110.26(C)(2) Large Equipment

Change Type: Revision

- Revisions to “Large Equipment” working space address the hazards presented by two or more service disconnects with combined ratings of 1200 amps or more.
- A new rule was added to prohibit an open equipment door from obstructing the entry to or egress from the required working space for large equipment.

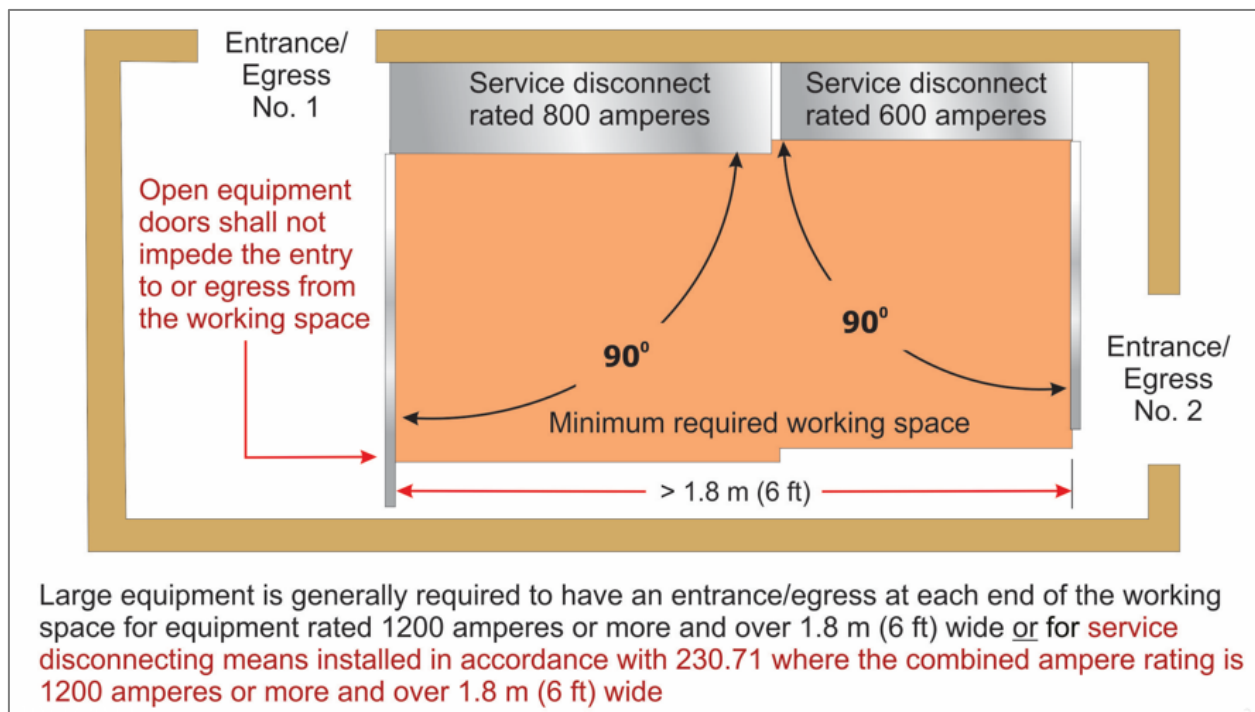

210.8 Measurements for GFCI Protection

Change Type: Revision

- Revision removes “door” and “doorway” as items the supply cord of an appliance connected to the receptacle should not pass through in order to satisfy measurement requirements for GFCI protection.

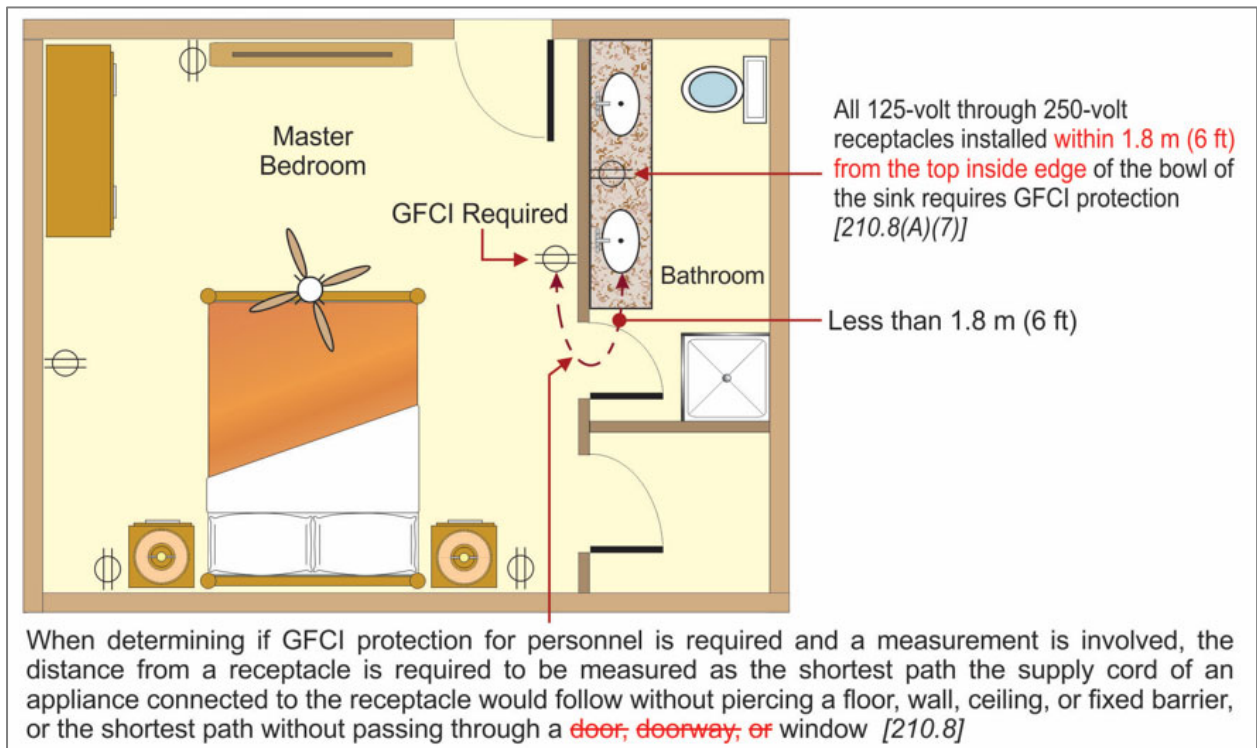

210.8(A) Dwelling Unit GFCI Protection (Revision)

- GFCI protection for personnel at dwelling units has been expanded to include all 125-volt through 250-volt receptacles supplied by single-phase branch circuits rated 150 volts or less to ground in the specific locations specified at 210.8(A)(1) through (A) (11) (bathrooms, kitchens, etc.).
- The list of required locations now includes 11 items (was 10) – adding “Indoor damp and wet locations”.

210.8(A)(5) GFCI Protection for Basements (Revision)

- GFCI protection is now required for **ALL** dwelling unit basements (*not just unfinished portions of basements*).
- All 125-volt through 250-volt receptacles supplied by a single-phase branch circuit rated 150 volts or less to ground installed in any and all dwelling unit basements require ground-fault circuit-interrupter (GFCI) protection for personnel.

210.8(A)(11) GFCI Protection for Indoor Damp or Wet Locations (Revision)

- List item (11) was added to 210.8(A) requiring GFCI protection for all 125-volt through 250-volt receptacles supplied by a single-phase branch circuit rated 150 volts or less to ground installed in **indoor damp or wet locations** regardless of its location.

210.8(B) GFCI Protection for other than Dwelling Units

Change Type: New

New provisions for GFCI protection were added for non-dwelling unit locations for receptacles:



Indoor
**Damp
and Wet
Locations**

Garages,
**accessory
buildings,
and service
bays**



**Laundry
areas**

**Bathtubs
and
shower
stalls**



210.8(B)(2) GFCI Protection for Kitchens and More

Change Type: New

- Additional language was added to clarify that areas not defined as a kitchen such as ice cream parlors, coffee shops, smoothie stores, etc., with a sink and permanent provisions for either food preparation or cooking have the same potential for shock hazards as a kitchen.

GFCI protection required for all 125-volt through 250-volt receptacles supplied by single-phase branch circuits rated 150 volts or less to ground, 50 amperes or less and all receptacles supplied by three-phase branch circuits rated 150 volts or less to ground, 100 amperes or less installed in areas defined as a “kitchen” and **areas with a sink and permanent provisions for either food preparation or cooking**

	
<p>Coffee Shop <i>(no permanent provisions for cooking)</i></p>	<p>Ice Cream Parlor <i>(no permanent provisions for cooking)</i></p>

210.8(D) GFCI Protection for Specific Appliances

Change Type: New

- New text at new 210.8(D) titled “specific appliances” and the move of the GFCI requirement for dishwashers correlates the requirements found in 422.5(B) (Type and location for GFCI protection for appliances) and refers to the list of appliances requiring GFCI protection in 422.5(A).



Dishwashers GFCI protection was moved from 210.8(D) to 422.5(A)(7)





Vending machine GFCI protection cannot be factory installed within the appliance

210.8(E) GFCI for Equipment Requiring Servicing

Change Type: New

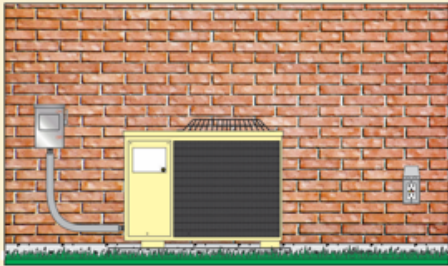
- GFCI protection is now required for the receptacles required by 210.63 for HVAC equipment, indoor service equipment, and indoor equipment requiring dedicated equipment space.

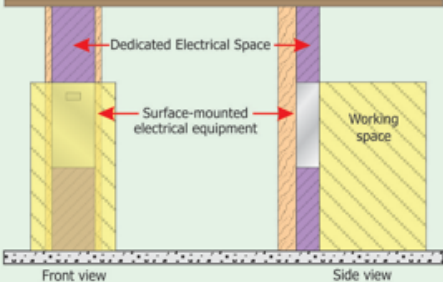
<p>210.63(A) HVAC and Refrigeration Equipment</p> 	<p>210.63(B)(1) Indoor Service Equipment</p> 
<p>210.63(B)(2) Indoor Equipment Requiring Dedicated Equipment Space</p> 	<p>GFCI protection shall be provided for the receptacles required by 210.63</p> <p>A 125-volt, single-phase, 15- or 20-ampere-rated receptacle outlet shall be installed at an accessible location within 7.5 m (25 ft) of the equipment as specified in 210.63(A) and (B)</p>

VA Deletes Section 210.8(F) / E3902.17 in its Entirety (GFCI Protection for Outdoor Outlets)



Change Type: Deletion (VA)

- Currently, separate standards for the tripping current of GFCI devices and the allowable leakage current of air conditioner condenser units **creates an incompatibility issue.**
- If GFCI protection is required while the incompatibility issue remains, there is a higher risk of people being adversely impacted by exposure to extreme temperatures due to nuisance tripping than the risk of people being exposed to a leakage current that could cause injury or harm.
- **VA Proposals RE2701.1.1-21 and RE3902.17-21**

~~**210.8(F) Outdoor Outlets.** All outdoor outlets for dwellings, other than those covered in 210.8(A)(3), Exception to (3), that are supplied by single-phase branch circuits rated 150 volts to ground or less, 50 amperes or less, shall have ground-fault circuit-interrupter protection for personnel. Exception No. 1: Ground-fault circuit-interrupter protection shall not be required on lighting outlets other than those covered in 210.8(C). Exception No. 2: Ground-fault circuit-interrupter protection shall not be required for listed HVAC equipment. This exception shall expire September 1, 2026.~~

~~**E3902.17 Outdoor outlets.**~~

~~All outdoor outlets, other than those covered in the exception to Section E3902.3, that are supplied by single-phase branch circuits rated 150 volts to ground or less, 50 amperes or less, shall have ground-fault circuit-interrupter protection for personnel. [210.8(F)]~~

~~**Exception:** Ground-fault circuit-interrupter protection shall not be required on lighting outlets other than those covered in Section E3902.15. [210.8(F) Exception]~~

210.11(C)(3) Bathroom Branch Circuit(s)

Change Type: Revision

- Additional text is added to clarify that the only bathroom receptacles required to be supplied by the 20-ampere rated bathroom receptacle outlet branch circuits are the receptacle outlet(s) required by 210.52(D) and any other receptacles installed in the bathroom that serve a countertop or similar work surface.



210.11(C)(4) Garage Branch Circuit(s)

Change Type: Revision

- Garage receptacle outlet 120-volt, 20-ampere branch circuits are only required for the receptacles required by 210.52(G)(1) for attached garages and in detached garages with electric power.

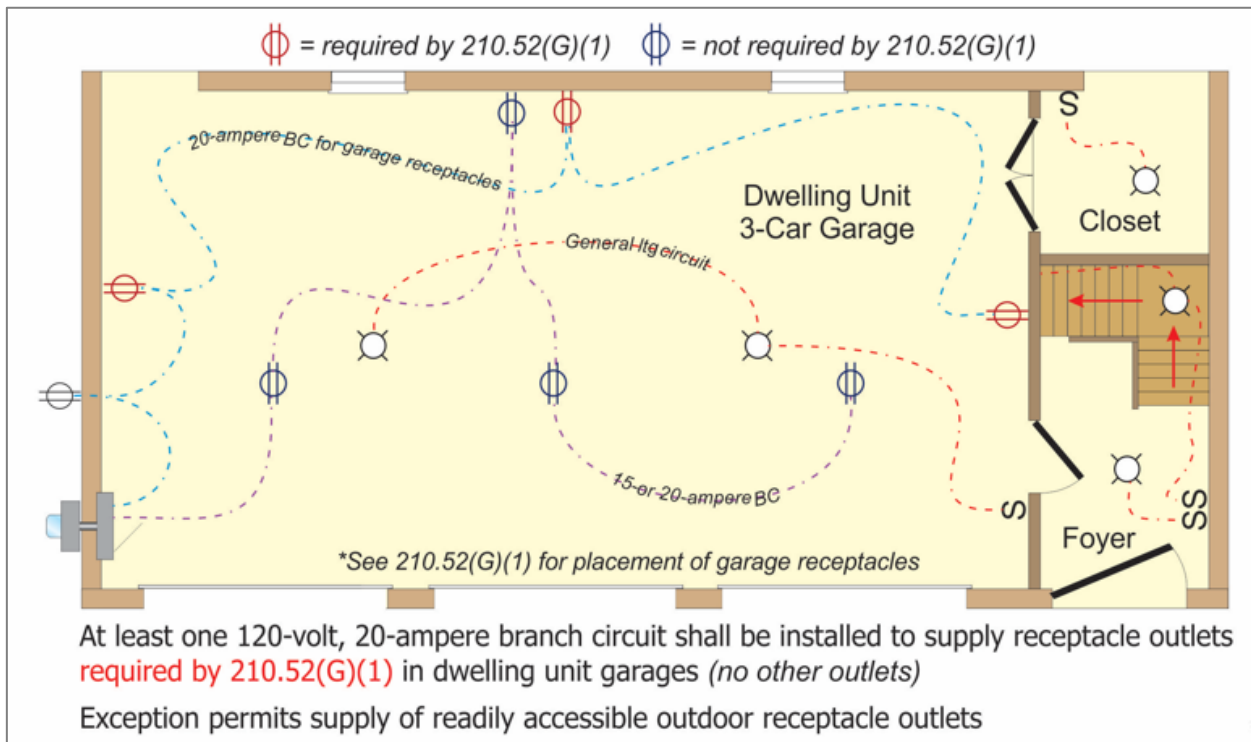

210.12(C) AFCI for Patient Sleeping Rooms in Nursing Homes and Limited-Care Facilities

Change Type: Revision

- AFCI protection has been expanded to patient sleeping rooms in nursing homes and limited-care facilities.
- AFCI technology will provide same protection from arcing faults to the occupants of these rooms that is afforded occupants of conventional dwelling units and guest rooms and guest suites of hotels and motels.

210.52(C) Countertops and Work Surfaces

Change Type: Revision

- Change clarifies that the receptacle outlets installed for countertop or work surfaces [210.52(C)] are not permitted to satisfy the requirement for receptacle outlet placement (wall spacing) as provided in 210.52(A).

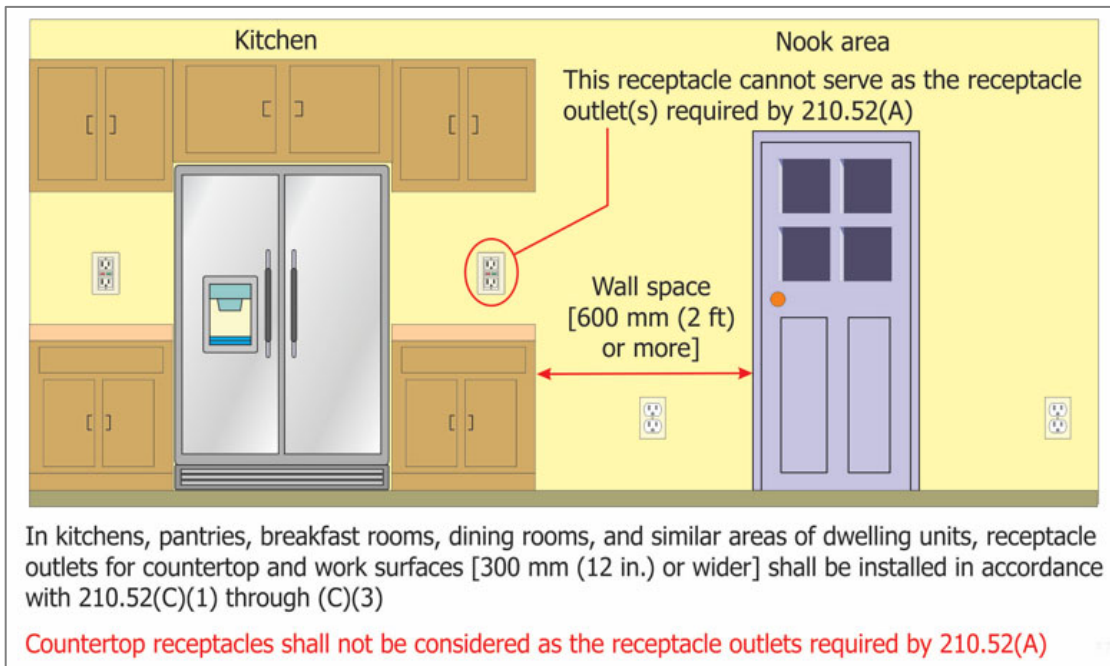

210.52(C)(2) Island and Peninsular Countertops and Work Surfaces

Change Type: Revision

- Revision creates two separate List Items for wall space, and island and peninsular countertops and work surfaces.
- For island and peninsular countertop and work surfaces, the horizontal measurement was changed to a square foot calculation to determine the number of receptacles required.

At least one receptacle outlet shall be provided for the first 0.84 m^2 (9 ft^2), or fraction thereof, of the countertop or work surface

A receptacle outlet shall be provided for every additional 1.7 m^2 (18 ft^2), or fraction thereof, of the countertop or work surface

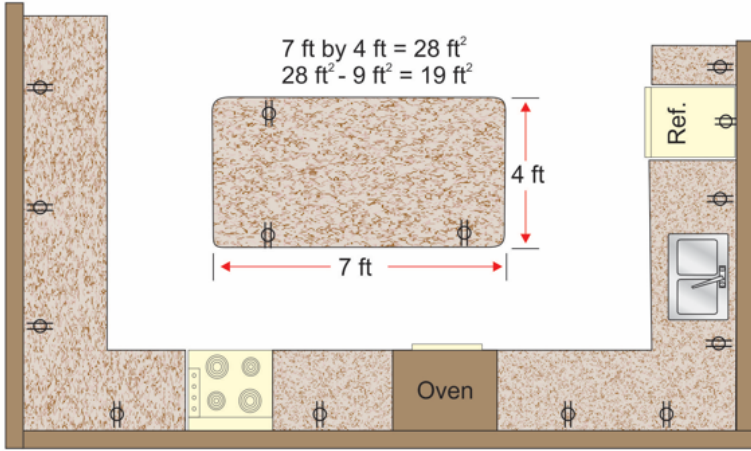

7 ft by 4 ft = 28 ft^2
 $28 \text{ ft}^2 - 9 \text{ ft}^2 = 19 \text{ ft}^2$

4 ft

7 ft

At least one receptacle outlet shall be located within 600 mm (2 ft) of the outer end of a peninsular countertop or work surface

Ref.

Oven

At least one receptacle outlet shall be provided for the first 0.84 m^2 (9 ft^2), or fraction thereof, of the countertop or work surface

A receptacle outlet shall be provided for every additional 1.7 m^2 (18 ft^2), or fraction thereof, of the countertop or work surface

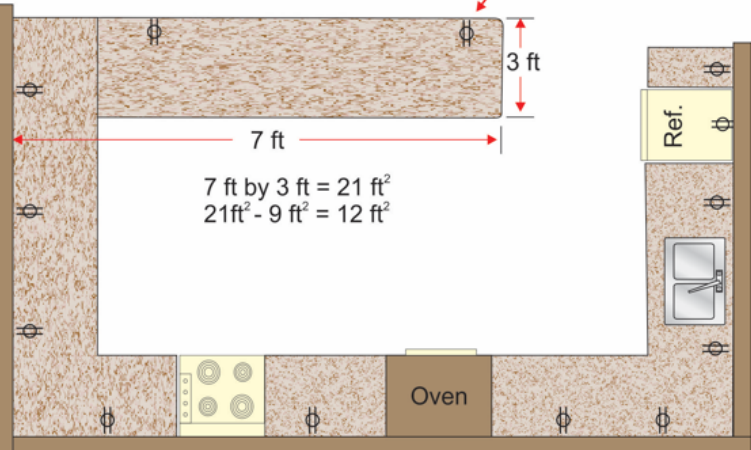

3 ft

7 ft

7 ft by 3 ft = 21 ft^2
 $21 \text{ ft}^2 - 9 \text{ ft}^2 = 12 \text{ ft}^2$

At least one receptacle outlet shall be located within 600 mm (2 ft) of the outer end of a peninsular countertop or work surface

Ref.

Oven

A peninsular countertop is to be measured from the connected perpendicular wall

215.9 GFCI Protection for Feeders

Change Type: Revision/Deletion

- Revision provides correlation with GFCI protection requirements in 210.8 by removing the existing limitations of a feeder to provide GFCI protection to only 15 and 20-ampere receptacle branch circuits.

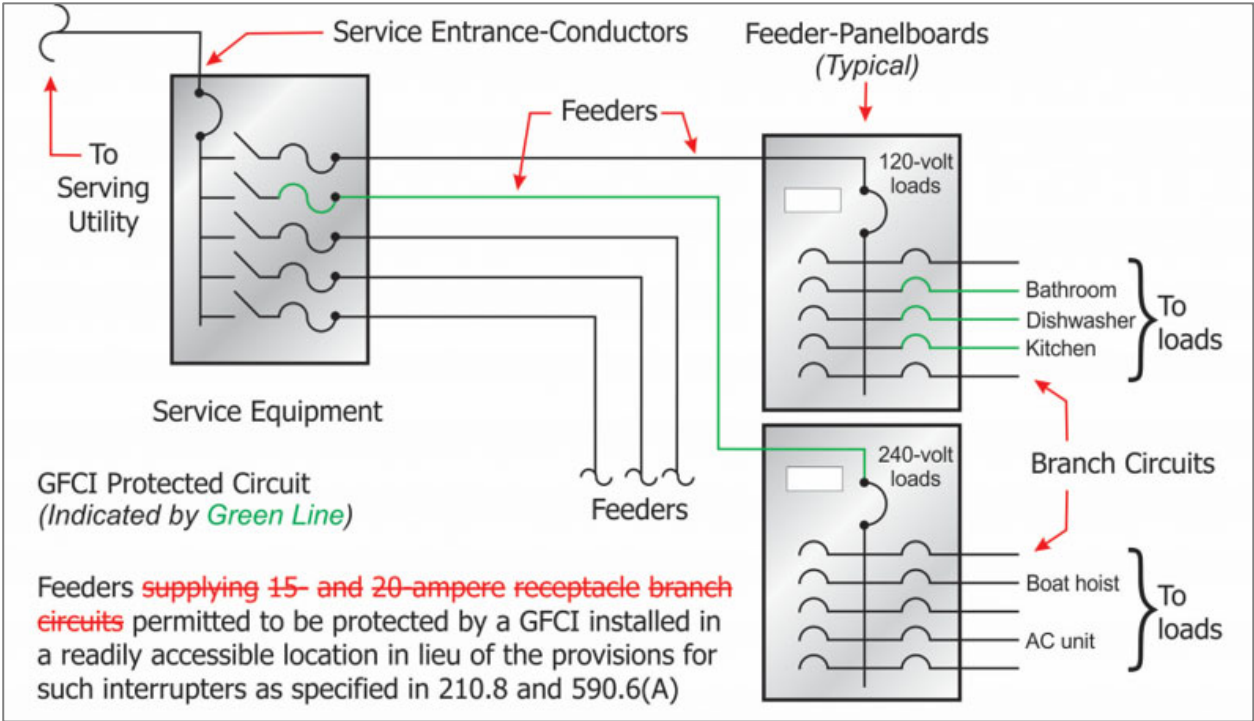
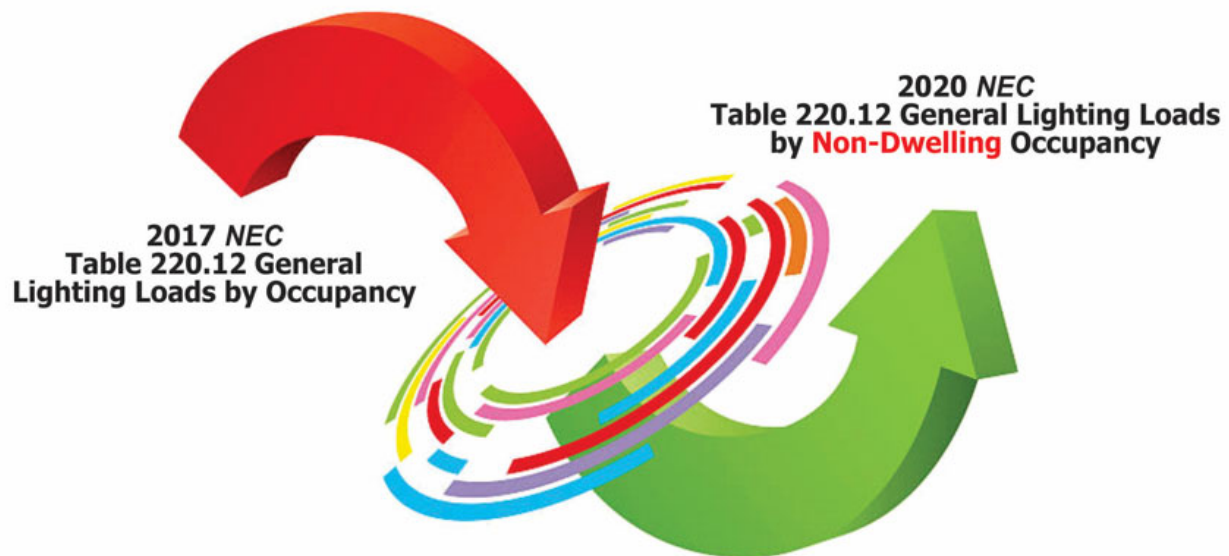

Table 220.21 General Lighting Loads by **Non-Dwelling** Occupancy

Change Type: Revision

- Section 220.12 and Table 220.12 received extensive revision with 29 occupancies now addressed for the 2020 NEC at Table 220.12.
- References to dwelling units and multi-family dwelling units were moved out of Table 220.12 as this revised table now only addresses non-dwelling unit occupancies.



220.53 Appliance Load – Dwelling Unit(s)

Change Type: Revision

- All household electric cooking equipment that is fastened in place (*not just an electric range*) has been added to the list of appliances that cannot be included in the four or more appliances eligible for a 75% derating demand factor.
- Another change involving 220.53 was to add a qualifier to the size of the appliance that can be included in the 75% derating.
 - By limiting the size of motor loads to ¼ hp or greater or 500 watts or greater, this standard will limit the “four or more” appliances to larger appliances as intended.

A demand factor of 75% can be applied to the nameplate rating load of 4 or more appliances **rated ¼ hp or greater, or 500 watts or greater**, that are fastened in place, and that are served by the same feeder or service in a one-family, two-family, or multifamily dwelling.

This demand factor cannot be applied to:

- (1) **household electric cooking equipment that are fastened in place (was just “electric ranges”)**
- (2) clothes dryers
- (3) space heating equipment
- (4) air conditioning equipment

Standard Load Calculation			
Appliances	Quantity	VA Ungrnd	VA Neutral
Dishwasher	1	1,500	1,500
Dishwasher (1/2 hp motor)	1	1,176	1,176
Compactor	1	600	600
Exhaust Fans (120 VA each)	2	240	240
Water Heaters (4,500 VA each)	2	9,000	
Totals	5	12,276	3,276
4 or more Appliances Total at 75%		9,207	2,457

225.30(B) Common Supply Equipment (Feeders)

Change Type: New

- New provisions are added to allow up to six feeders under very limited circumstances.

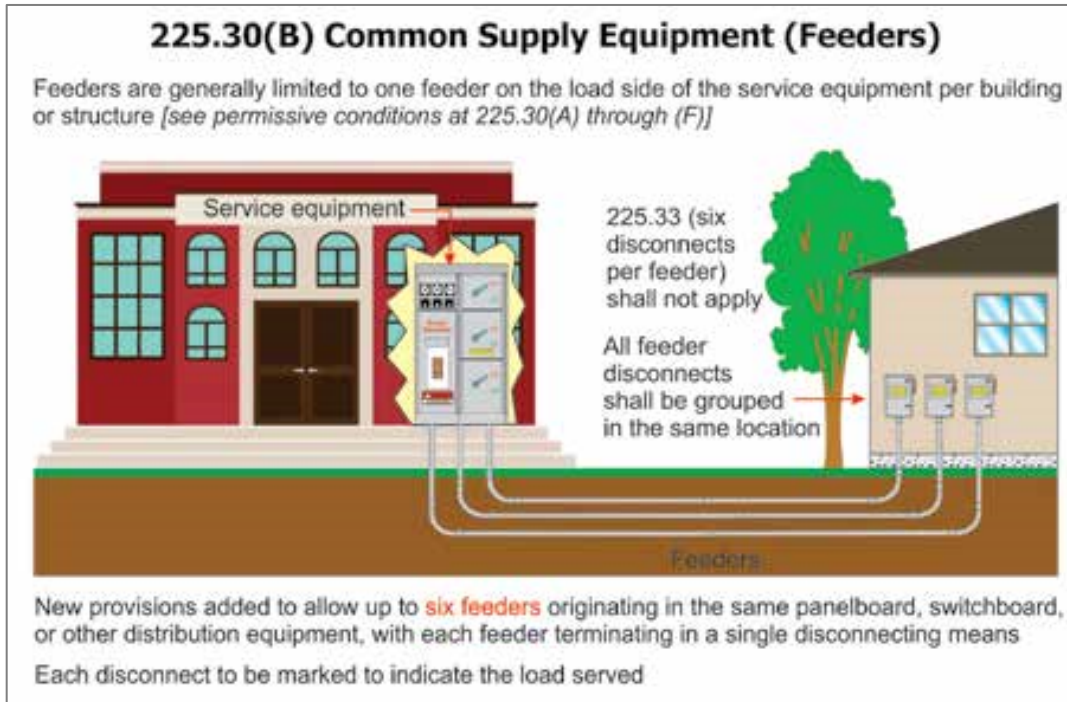

230.46 Spliced and Tapped Conductors

Change Type: Revision and relocation

- The requirement for power distribution blocks installed on service conductors required to be marked “suitable for use on the line side of the service equipment” or equivalent was moved to 230.46.
- All devices used to splice service conductors must be listed and marked as “suitable for use on the line side of the service equipment” or equivalent by January 1, 2023.

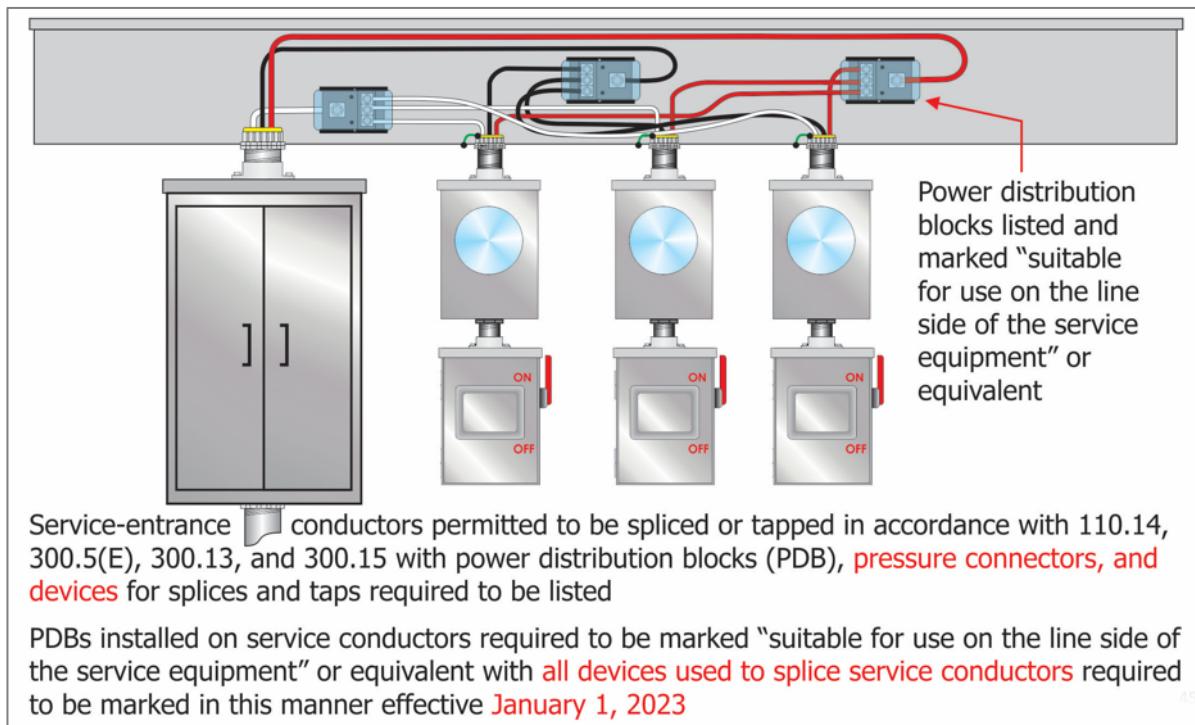

230.67 Surge Protection for Dwelling Units

Change Type: New

- All dwelling unit services are now required to be provided with surge-protection.
- The surge protection device (SPD) must be an integral part of the service equipment or located immediately adjacent to the service equipment unless it is supplied at each next level distribution equipment downstream toward the load.
- This SPD is required to be either a Type 1 or Type 2 SPD.

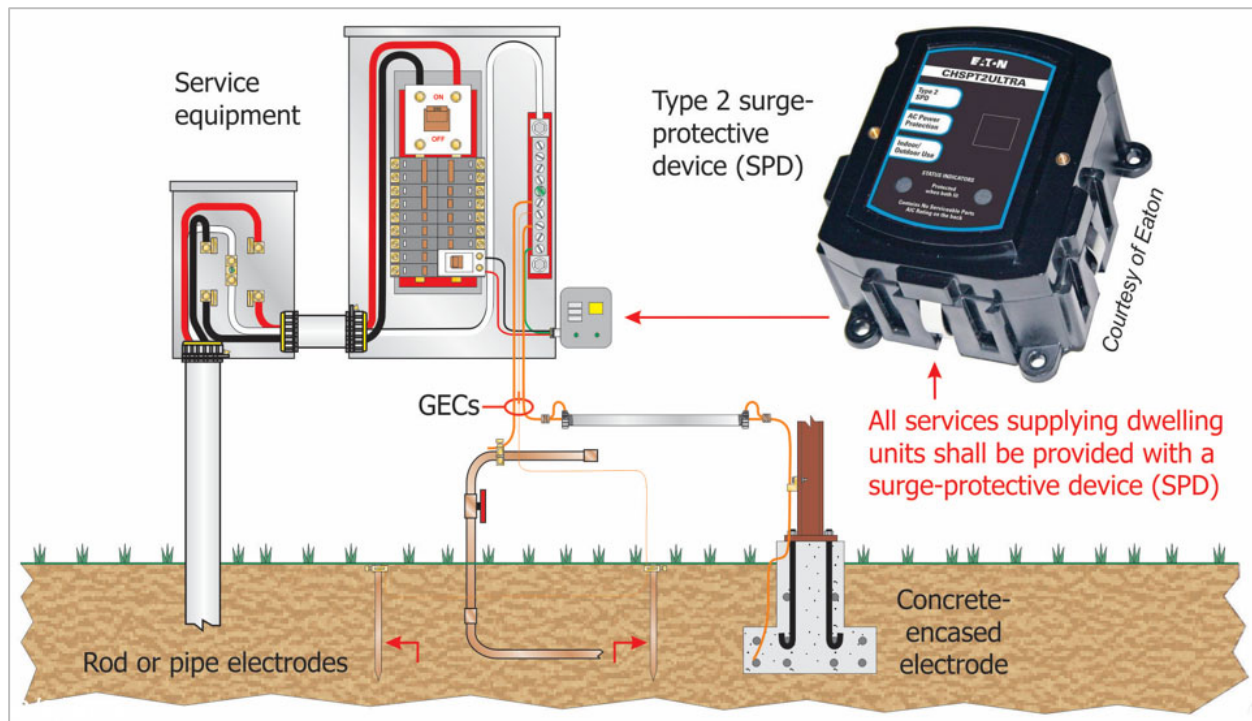

230.71(A) and (B) Maximum Number of Disconnects

Change Type: Revision

- This revision eliminates more than one service disconnecting means in the same panelboard or other enclosure.
- The six service disconnect rule for services remains; however, the permission for up to six service disconnects is modified to require installation in separate enclosures only.

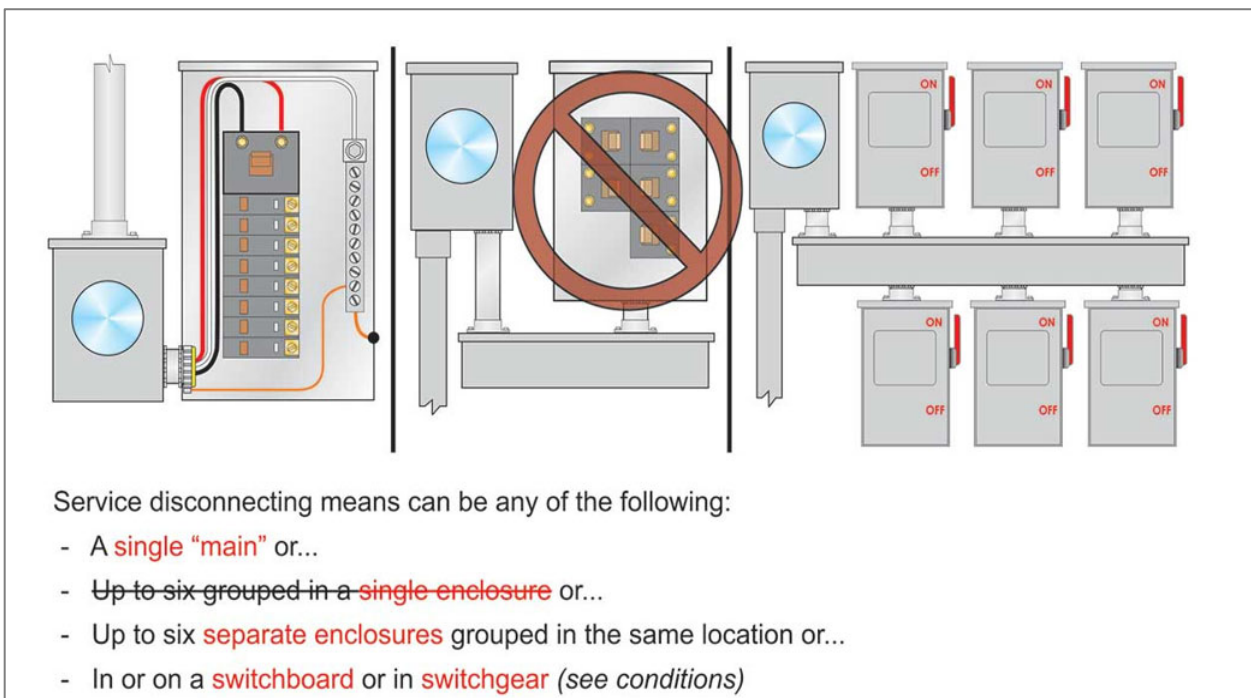

230.85 Exterior Emergency Disconnect(s) for Dwelling Units

Change Type: New

- A new requirement is added to require an emergency disconnect at a readily accessible outdoor location for dwelling units.

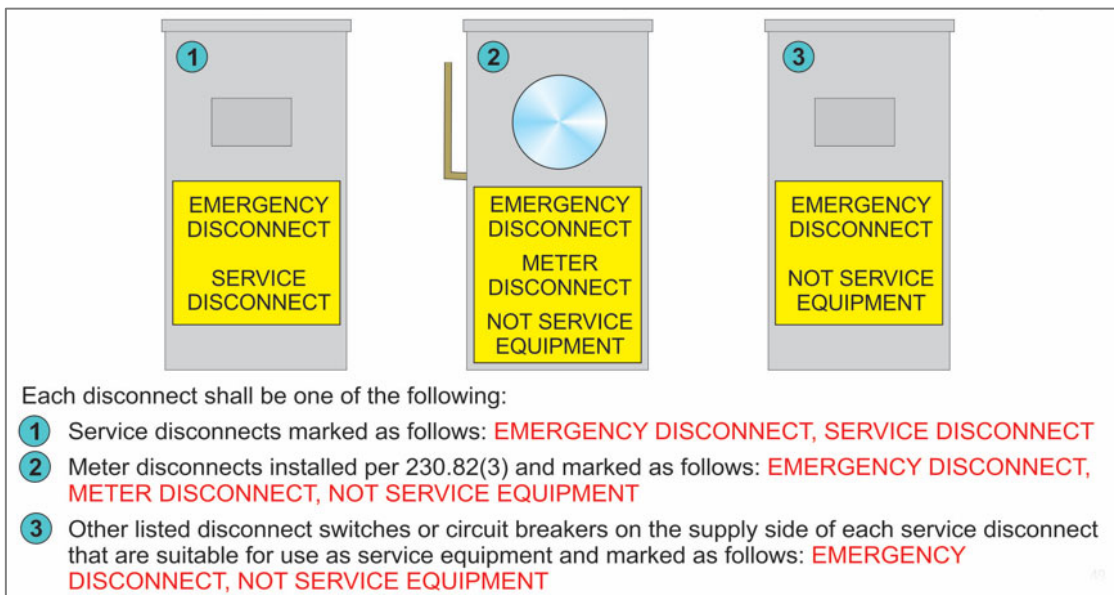
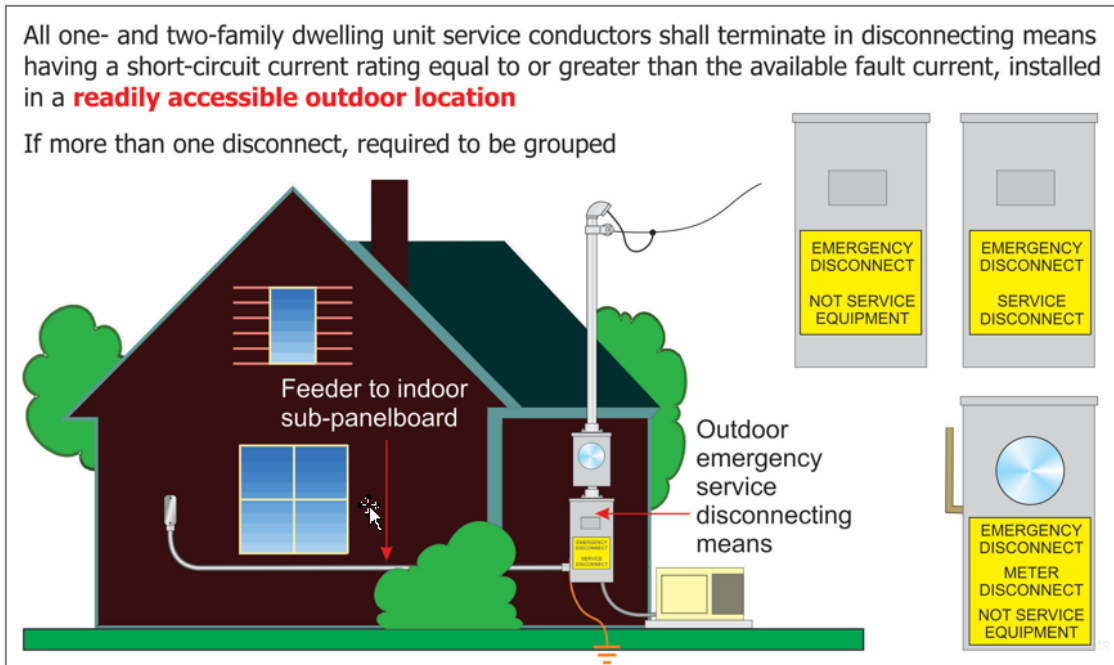

250.25 Grounding Systems Permitted to be Connected on the Supply Side of the Disconnect.

Change Type: New

- A new section was added dealing with grounding and bonding requirements for systems connected on the supply side of the service disconnect(s). This new section points users of the *Code* to 250.24 for the grounding and bonding requirements for these supply-side disconnects.

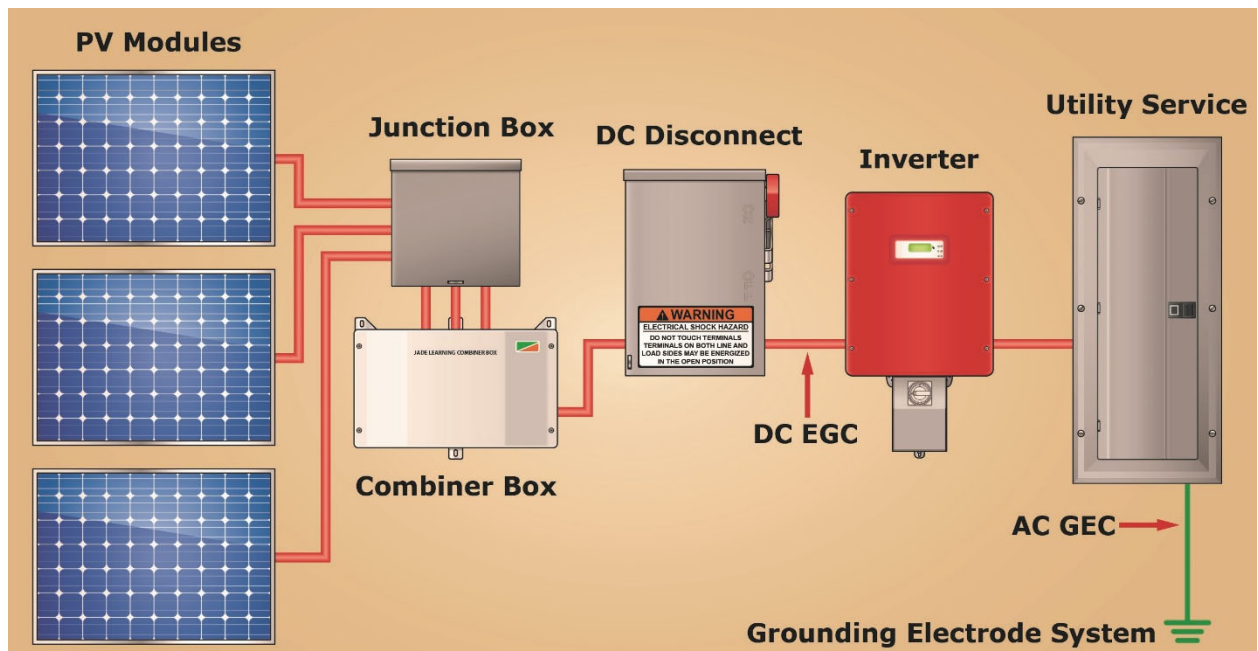

250.64(B)(2) and (B)(3) Grounding Electrode Conductor Protection from Physical Damage

Change Type: Revision

- The same wiring methods permitted to provide protection from physical damage in the 2017 NEC are still permitted for the 2020 NEC. However, **Schedule 80 PVC** is now specified as the only type of PVC that can provide protection from physical damage.



250.104(A)(1) Bonding of Metal Water Piping Systems

Change Type: Revision

- Bonding jumper(s) used to bond metal water piping system(s) together are not required to be larger than 3/0 copper or 250 kcmil aluminum or copper-clad aluminum.

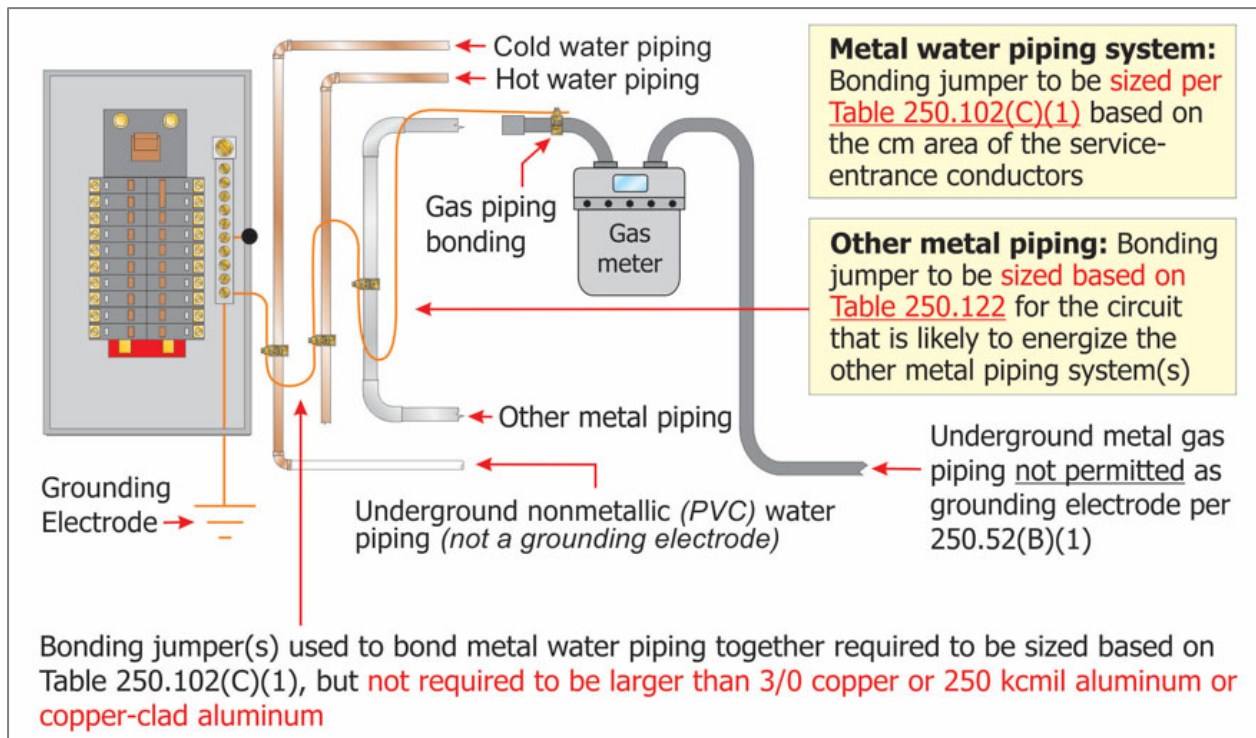

250.148 Continuity of EGCs and Attachment *in* Boxes

Change Type: Revision

- This revision clarifies that all wire-type equipment grounding conductors associated with any of those spliced circuit conductors must be connected within the box or to the box.

If circuit conductors are spliced within a box or terminated on equipment within or supported by a box, all **wire-type** equipment grounding conductor(s) associated with any of those circuit conductors shall be connected within the box or to the box ~~with devices suitable for the use~~ in accordance with 250.8 and 250.148(A) through (D)

See exception for isolated ground receptacles at 250.146(D)

EGC not associated with any of those circuit conductors

EGC from branch circuit (all conductors not shown)

Bonding jumper for connection to metal box

Bonding jumper to receptacle

Metal box

A connection **used for no other purpose** shall be made between the **metal box** and the **equipment grounding conductor(s)** in accordance with 250.8

Table 310.16 310.15(B)(16) Ampacity Tables

Change Type: Revision

- The ampacity tables will simply be titled as Table 310.16 through Table 310.21 (Example: Table 310.15(B)(16) will now be simply Table 310.16).

314.16(B)(5) Box Fill Calculations – EGC Conductor Fill

Change Type: Revision

- An additional ¼ volume allowance is now required to be added to the existing volume allowance of a single conductor volume allowance based on the largest equipment grounding conductor or equipment bonding jumper entering the box.
- New ¼ volume allowance to be counted in installations with more than four EGCs or equipment bonding conductors.

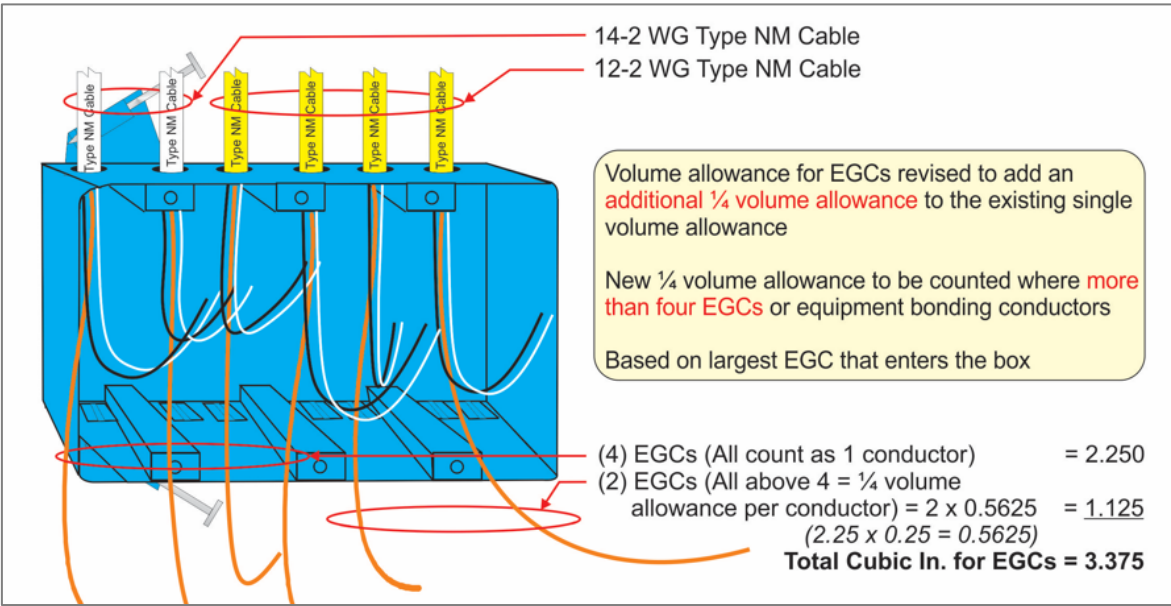

314.27(C) Boxes at Ceiling-Suspended (Paddle) Fan Outlets

Change Type: Revision

- This revision will now generally require all outlet boxes mounted in a location acceptable for the installation of a ceiling-suspended (paddle) fan in the ceilings of habitable rooms of dwelling units to be listed for the sole support of ceiling-suspended (paddle) fan.

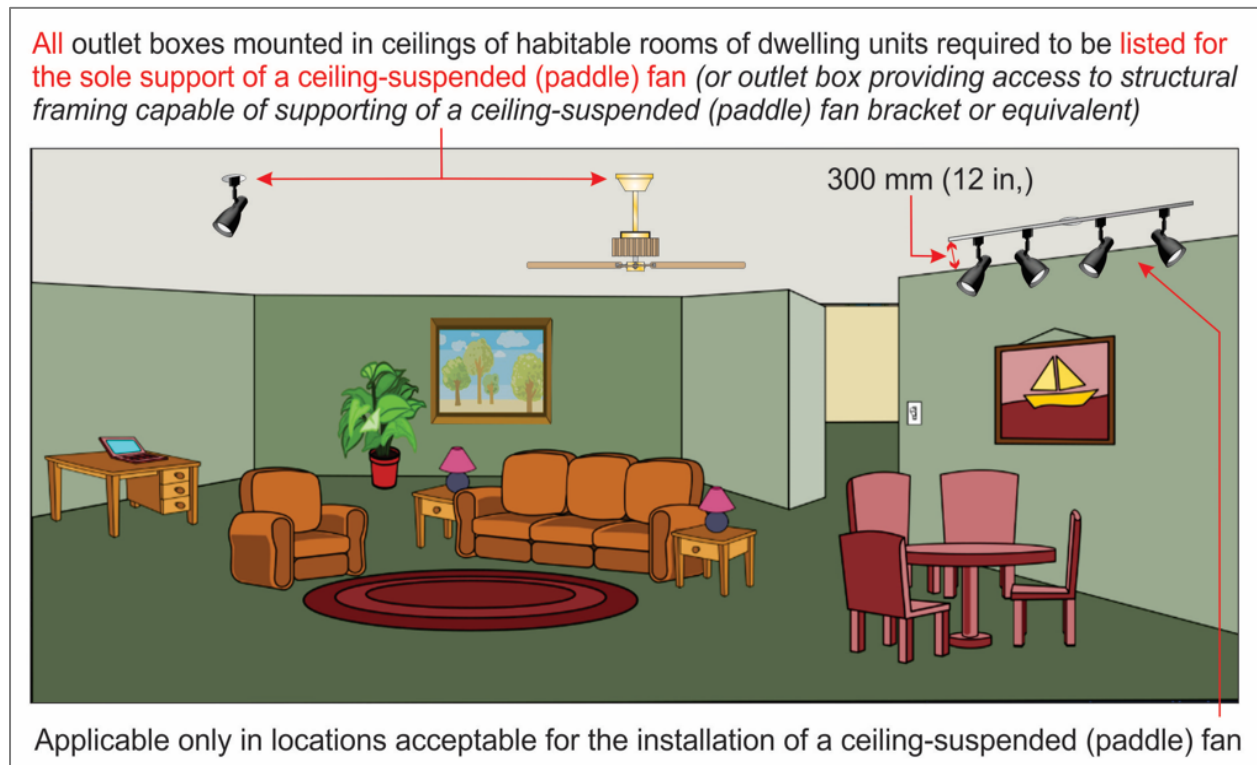

Note: In the picture above, an outlet listed for the sole support of a ceiling-suspended (paddle) fan or an outlet box complying with the applicable requirements of 314.27 and providing access to structural framing capable of supporting of a ceiling-suspended (paddle) fan bracket or equivalent must be installed at the single spotlight and fan locations, but not at the track lighting that is within 12" of the wall.

320.80(A) Type AC Cable Ampacity-Thermal Insulation

Change Type: New

- New *Code* text was added at **320.80(A)** requiring armored cable (Type AC cable) to comply with adjustment factors of Table 310.15(C)(1) when installed without maintaining spacing.

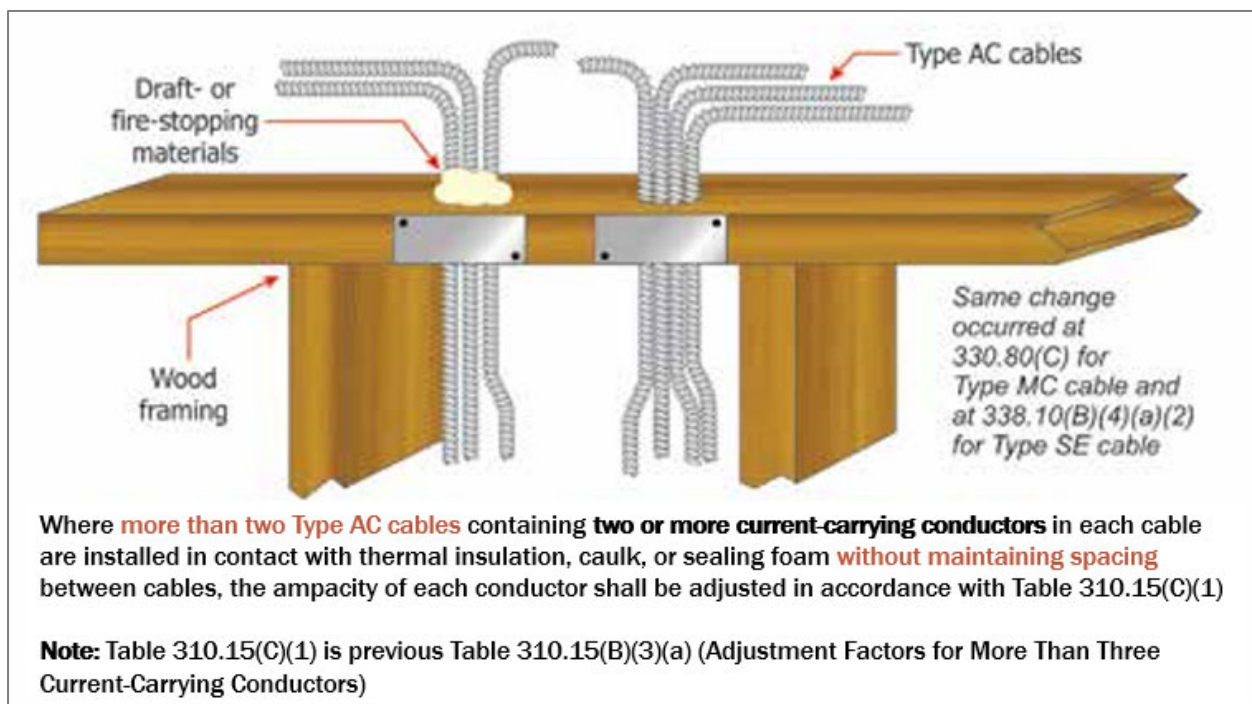

Article 337 Type P Cable

Change Type: New

A **new article** was added covering the use, installation, and construction specifications for **Type P cable**



Type P Cable: A factory assembly of one or more insulated flexible tinned copper conductors, with associated equipment grounding conductor(s), with or without a braided metallic armor and with an overall nonmetallic jacket.

404.14 Rating and Use of Switches

Change Type: Revision

- Switches will now be required to be **listed** and used within their ratings
- Switches of the types covered in **404.14(A) through (E)** are limited to the control of loads as specified accordingly
- Switches used to control **cord-and-plug-connected loads** are limited as covered in **404.14(F)**
- Equipment used in electrical installations should be listed or labeled by a qualified, third-party electrical products testing laboratory
- **UL 20** (Standards for General-Use Snap Switches) and **UL 1472** (Solid-State Dimming Controls) are among the switching device standards that provide the identified construction, performance, and marking requirements for switching devices to be used in accordance with the *NEC*

406.5(G)(2) Receptacle Mounting Under Sinks

Change Type: New

- Receptacle outlets are now **prohibited** from being installed in the area **beneath a sink in the face-up position**
- Receptacle outlets have been prohibited from being installed in the face-up position in or on **countertop surfaces or work surfaces** since the **2002 NEC (dwelling units)** and all countertops and work surfaces since the **2014 NEC**
- It's not uncommon to see plumbing pipes connecting to a sink (supply and drain) leaking from time-to-time under a sink area such as a kitchen sink
- A receptacle installed face-up under the sink is subject to water entering the **polarized slots of the receptacle** creating a hazardous condition
- New language will help mitigate a **potential hazard**



406.9(C) Bathtub and Shower Space

Change Type: New/Revision

- Receptacles are now prohibited from being installed within a **zone measured 3 ft. horizontally and 8 ft. vertically from the top of the bathtub rim or shower stall threshold**. This zone is all-encompassing and includes the space directly over the tub or shower stall.
- In bathrooms with dimensions less than the required zone, receptacle(s) are permitted to be installed opposite the bathtub rim or shower stall threshold on the farthest wall within the room. (**Exception 1 – second illustration below**)

Note: In dwelling units, **Exception 2** (added via TIA 20-15 –Effective 12/28/2021) provides options for a single receptacle for “an electronic toilet or personal hygiene device such as an electronic bidet seat”. (Not shown in illustrations)

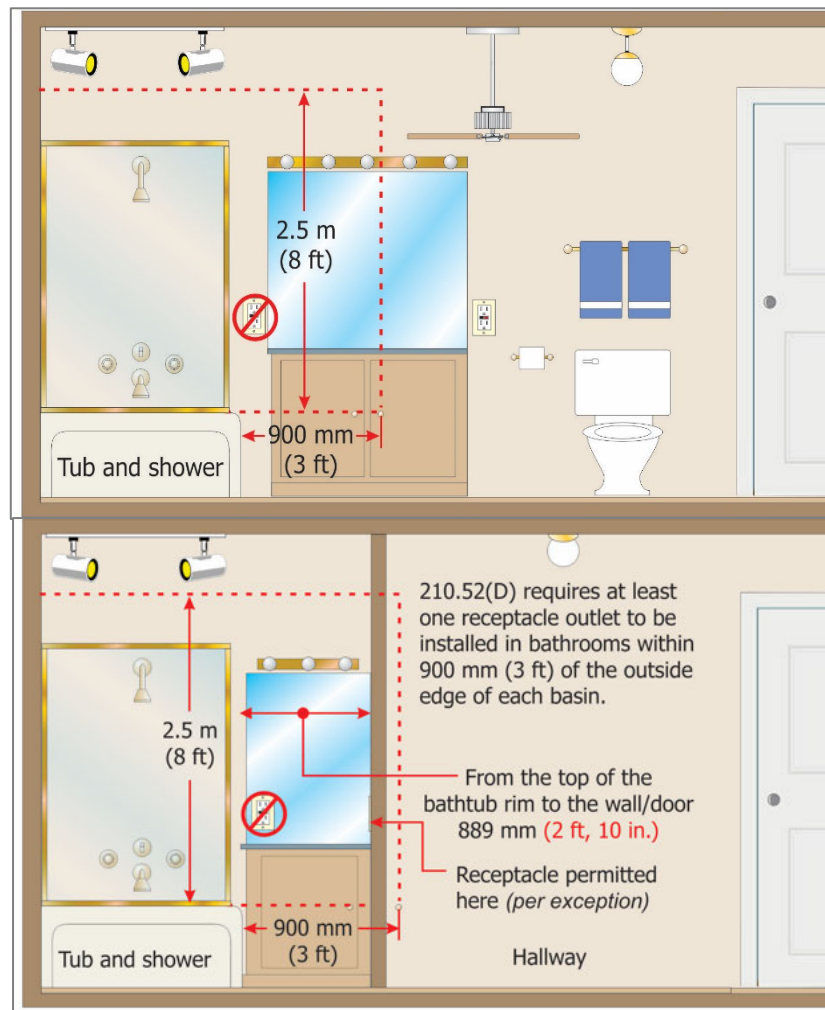

406.12 Tamper Resistant Receptacles

Change Type: New/Revision

- Requirements for tamper-resistant (TR) receptacles were expanded to attached and detached garages and accessory buildings of dwelling units.
- Common areas of multifamily dwelling units and hotels and motels are included as well.
- New List Item (8) was added for assisted living facilities.

TR receptacles requirements or clarification was expanded to the following areas:



Attached and detached garages and accessory buildings to dwelling units

Common areas of multifamily dwellings and common areas of guest rooms and guest suites of hotels and motels

Assisted living facilities as small children can be present in these facilities as well

408.6 Short-Circuit Current Rating for Switchboards, Switchgear, and Panelboards

Change Type: New

- A new requirement is added to Article 408 requiring available fault current and date calculation was performed to be field marked on the enclosure at the point of supply for switchboards, switchgear, and panelboards (other than dwelling units).

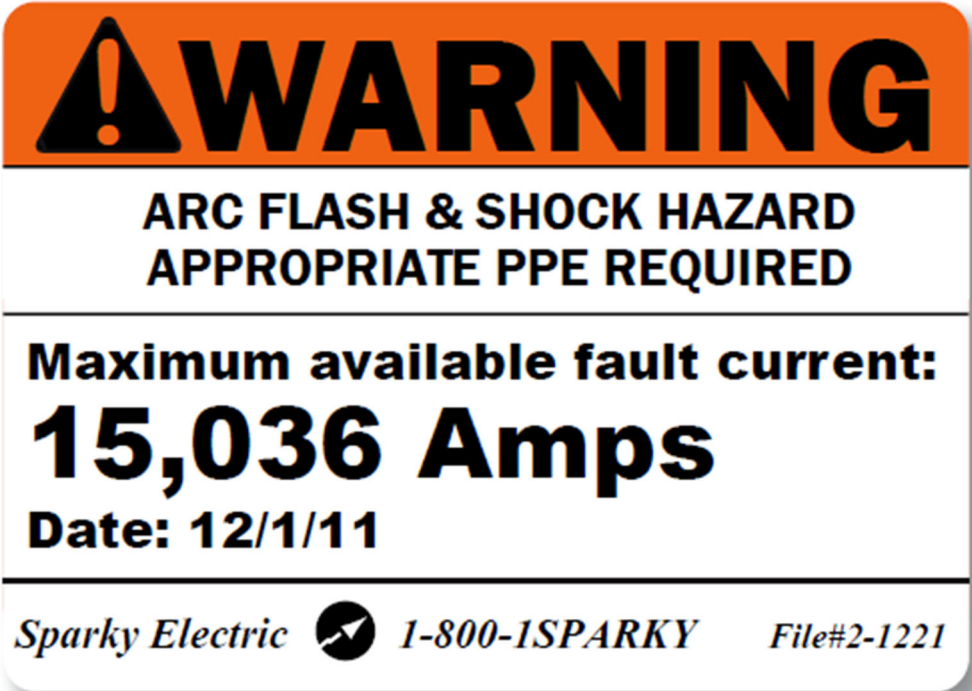

Sample available fault-current label

408.43 Panelboard Orientation

Change Type: New

- New 408.43 will now prohibit a panelboard from being mounted in the face-up position.



410.116(C) Recessed Luminaires Installed in Fire-Resistant Construction

Change Type: Revision

- The requirements for recessed luminaires installed in fire-resistance construction revised to be consistent with current listing options and relocated to 410.116(C).
- Requirements were updated with provisions that address the use of recessed LED luminaires.

Recessed luminaires installed in fire-resistant construction must be **listed for use in a fire-rated construction** and required to be installed in or used with a **luminaire enclosure that is listed for use in a fire-rated construction**

Must also be installed in accordance with a tested **fire resistance-rated assembly**

Recessed LED luminaires of comparable construction permitted for recessed installations in a building of fire-resistant construction

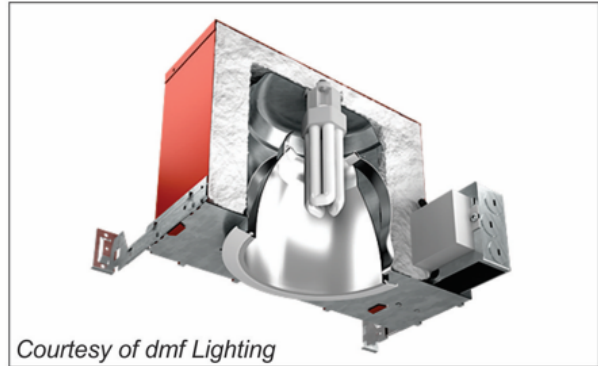

Courtesy of dmf Lighting

Luminaires marked **“FOR USE IN NON-FIRE-RATED INSTALLATIONS”** prohibited in fire-rated installations

410.118 Access to Other Boxes

Change Type: New

- This new section has been added to clarify that a luminaire cannot be used to access outlet, pull, or junction boxes or conduit bodies that are not associated with wiring for that luminaire.

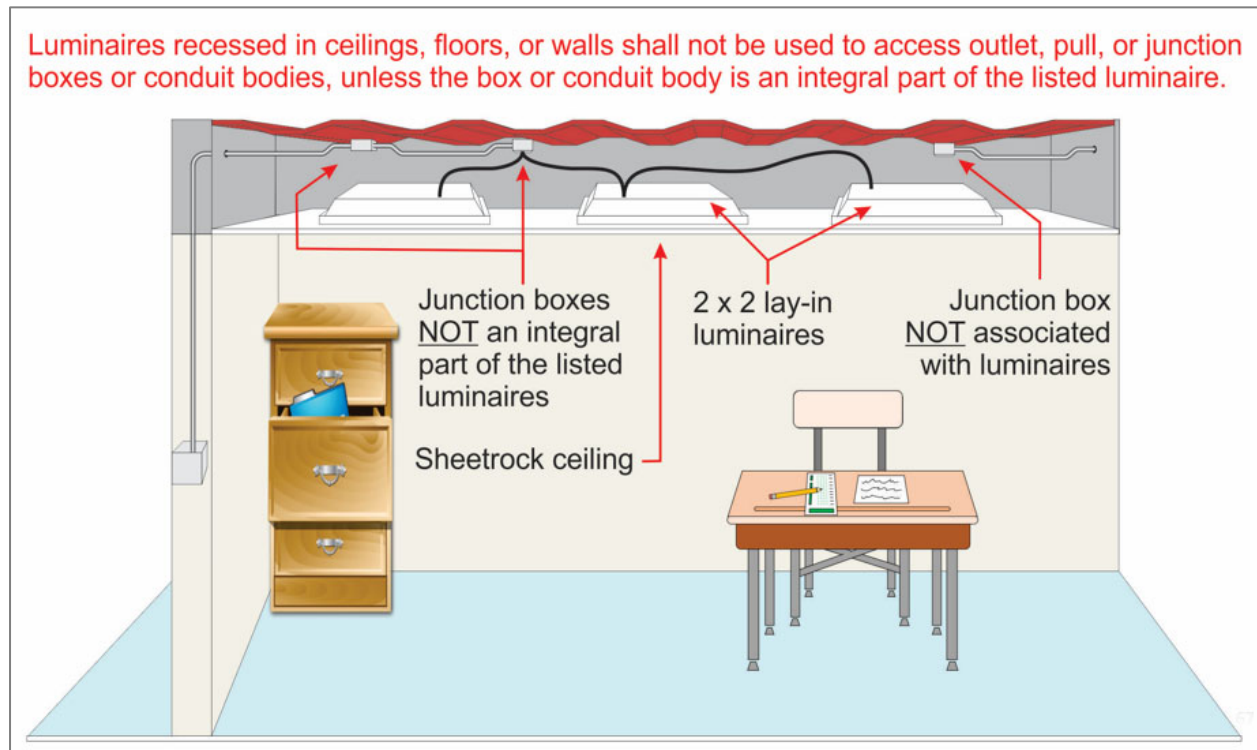

422.5(A) GFCI Protection for Appliances

Change Type: New/Revision

- The “provided for public use” condition has been removed from GFCI requirements for both automotive vacuum machines and tire inflation machines.
- Sump pumps has been added to the list of appliances requiring GFCI protection.
- Bottle fill stations was added to GFCI requirements for drinking water coolers.
- GFCI requirements for dishwashers moved from 210.8(D) to 422.5(A)(7).

GFCI requirements for Appliances (*150 volts or less to ground and 60 amperes or less, single- or 3-phase*) shall be provided with **Class A** GFCI protection for personnel (*Multiple GFCI devices permitted but not be required*)



(1) Automotive vacuum machines ~~provided for the public~~; (2) Drinking water coolers and bottle fill stations; (3) Cord-and-plug-connected high-pressure spray washing machines; (4) Tire inflation machines ~~provided for the public~~; (5) Vending machines; (6) Sump pumps; (7) Dishwashers

445.18(D) Emergency Shutdown Device at Dwelling Units

Change Type: New

- An **outdoor emergency generator shutdown device** is required for generators installed at one- and two-family dwelling units (other than cord-and-plug-connected generators).

445.18 Disconnecting Means and Emergency Shutdown of Prime Mover.

(A) Disconnecting Means.

(B) Emergency Shutdown of Prime Mover.

(C) Remote Emergency Shutdown.

(D) Emergency Shutdown in One- and Two-Family Dwelling Units. For other than cord-and-plug-connected portable generators, an emergency shutdown device shall be located outside the dwelling unit at a readily accessible location.

~~(E)~~ (E) Generators Installed in Parallel.

(see 2020 NEC for complete text.)



501.10(A)(1) Wiring Methods – Class I, Division 1 Locations

Change Type:

- **Type TC-ER-HL cable** and **Type P cable** were added as two new wiring methods for Class I, Division 1 locations.

Two additional wiring methods have been incorporated into 501.10(A)(1) as acceptable wiring methods in Class I, Division 1 locations



Type TC-ER-HL cable where not subject to physical damage and terminated with fittings listed for the location



Type P cable with metal braid armor, with an overall jacket, terminated with fittings listed for the location

Both limited to industrial establishments with restricted public access, where the conditions of maintenance and supervision ensure that only qualified persons service the installation

511.12 GFCI Protection at Commercial and Repair and Storage Garages

Change Type: Revision

- This revision to 511.12 now points and aligns GFCI requirements for commercial garages to GFCI requirements of 210.8(B).

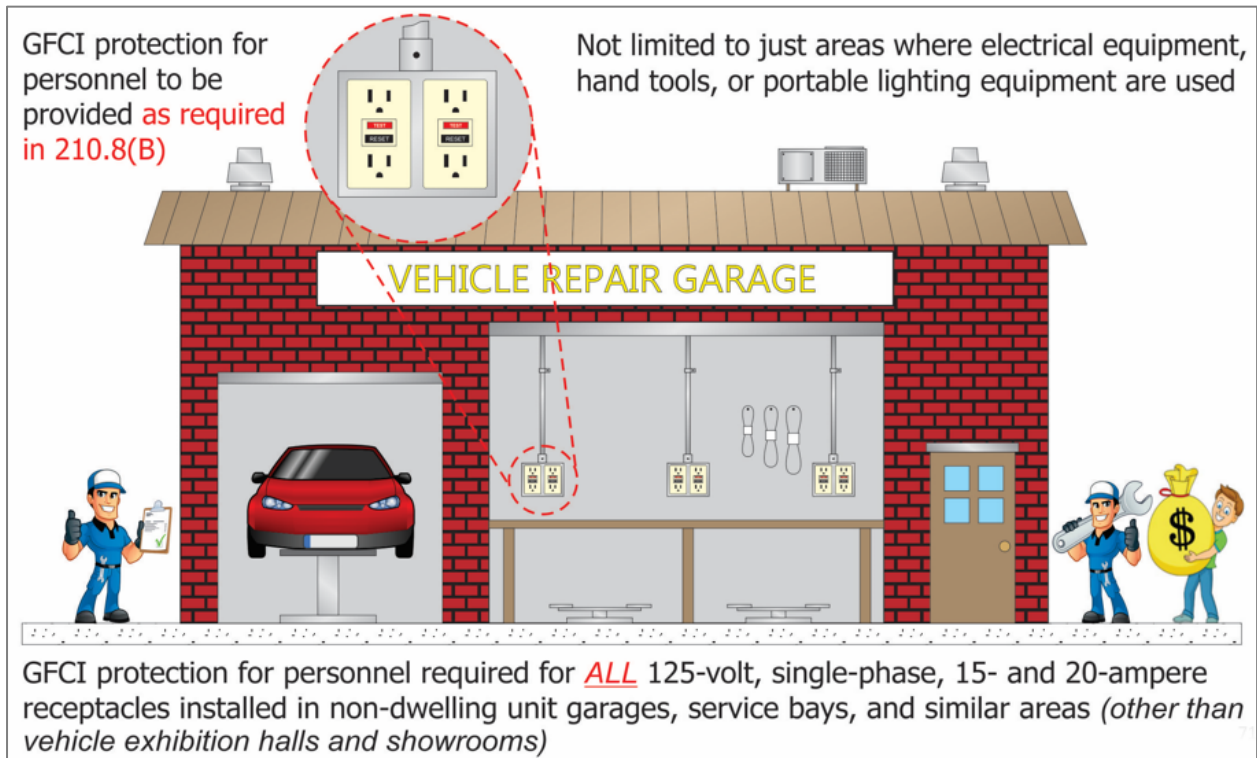

517.10(B) Applicability (Health Care Facilities)

Change Type: New

- New areas not covered by the wiring and protection methods of Part II of Article 517 have been added to 517.10(B), to include areas used exclusively for:
 - Intramuscular injections (immunizations)
 - Psychiatry and psychotherapy
 - Alternative medicine
 - Optometry
- These areas would normally be considered patient care spaces and would have to comply with the special wiring methods in Part II of Article 517 (i.e., metal raceways, “redundant” grounding, etc.)
- Shock hazards are greatly reduced with **no invasive procedures** performed and **no electro-medical equipment** connected to the body or patient

517.16 Use of Isolated Ground Receptacles

Change Type: Revision

- Further revision to 517.16 provides better explanation of use of isolated receptacles outside the patient care vicinity.
- Where installed, an isolated ground receptacle cannot eliminate the two equipment grounding paths required by 517.13.

An isolated ground receptacle (if installed) shall not defeat the purposes of the equipment grounding systems detailed in 517.13 (two paths for equipment grounding in a patient care space)

- ① Metal raceway that qualifies as EGC [517.13(A)]
- ② Additional insulated EGC [517.13(B)(1)]
- ③ Isolated ground EGC [517.16(B)(1) and 250.146(D)]

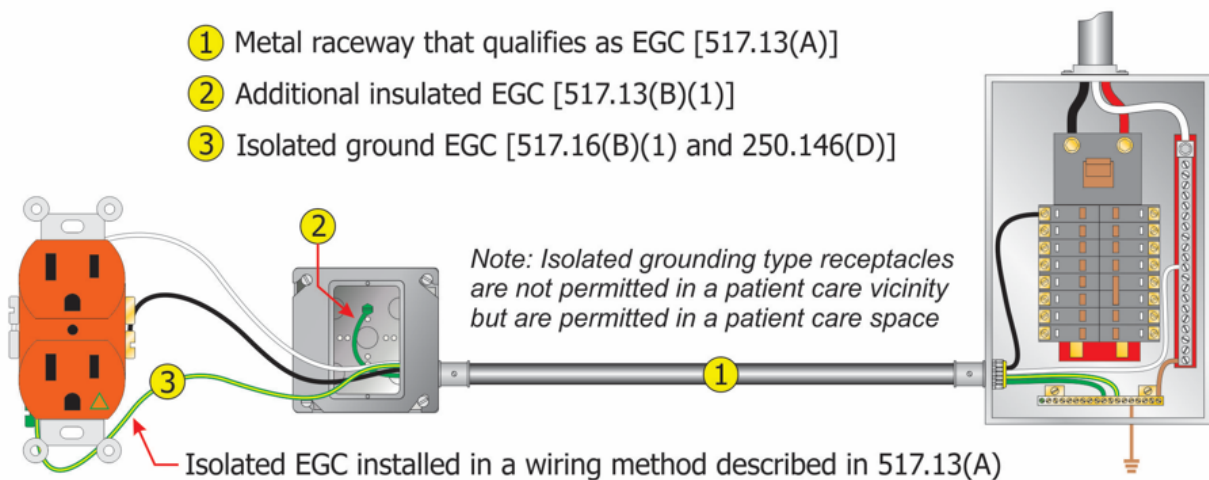

Equipment grounding terminals of isolated ground receptacles installed in a patient care space shall be connected to an isolated equipment grounding conductor AND this isolated equipment grounding conductor must be "installed in a wiring method described in 517.13(A)"

517.26 Application of Other Articles (Health Care Facilities)

Change Type: New

- [Section 517.26](#) was revised to add four specific amendments to Article 517 from requirements of Article 700.

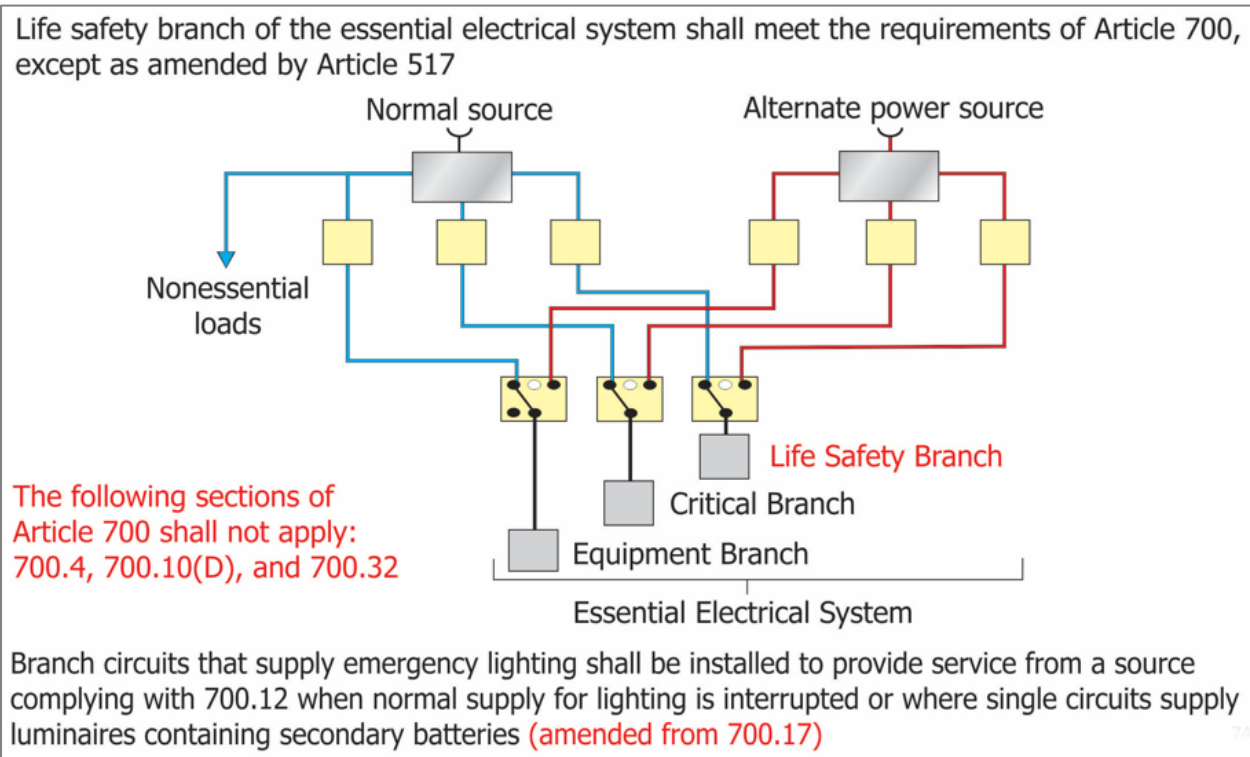

517.31(C)(1)(a) Identification of Essential Electrical Systems

Change Type: New

- Identification and marking requirements for the life safety branch and critical branch of essential electrical systems was added to 517.31(C)(1)(a).
- Raceways and cables required to be field- or factory-marked as a component of the essential electrical system at intervals not to exceed 7.6 m (25 ft).

Raceways, cables, or enclosures of the **life safety** and **critical branch** shall be **readily identified** as a component of the **essential electrical system (EES)**

Boxes and enclosures (including transfer switches, generators, and power panels) shall be field- or factory-marked and identified as a component of the EES

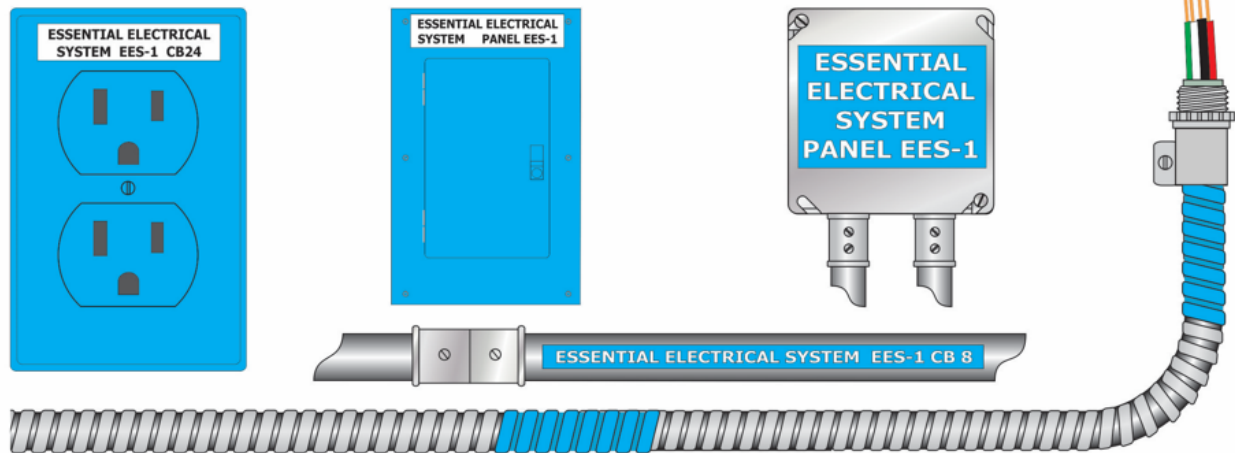

Raceways and cables shall be field- or factory-marked as a component of the EES at intervals **not to exceed 7.6 m (25 ft)**

75

518.6 Outdoor Illumination – Assembly Occupancies

Change Type: New

- A new section was added to require outdoor fixed service equipment at assembly occupancies to be provided with proper illumination.

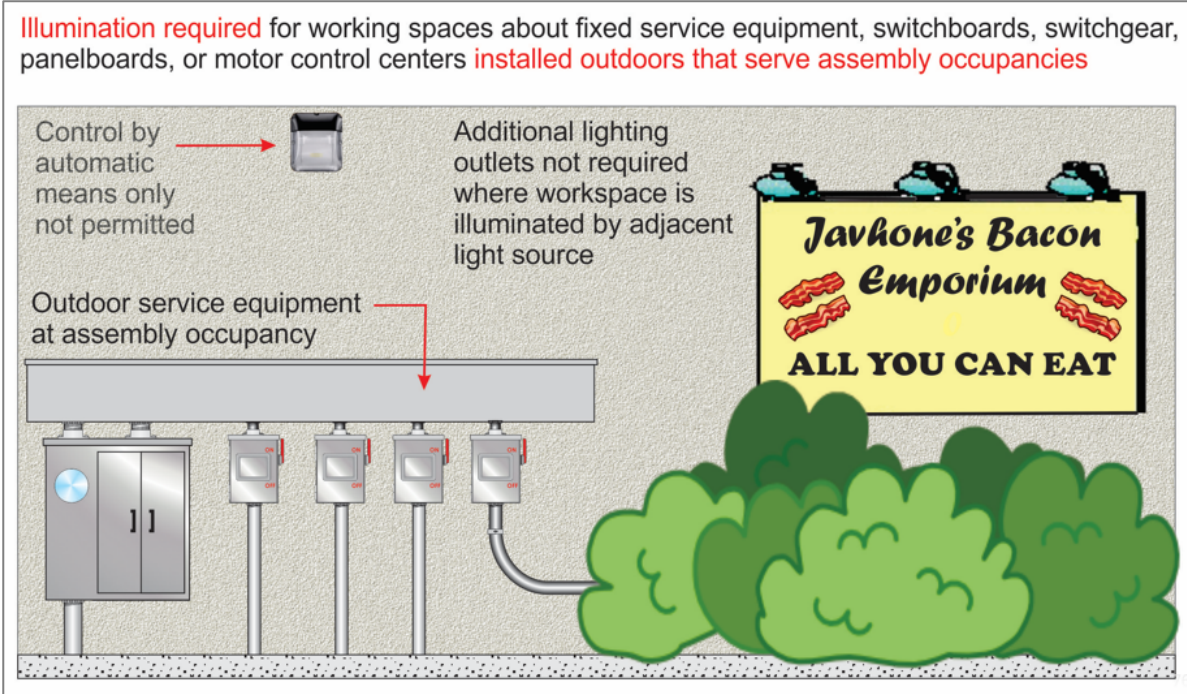

600.5(B) Marking Requirements at Disconnects

Change Type: New

- The disconnecting means for a sign, outline lighting system, or controller is now required to be marked to identify the sign, outline lighting system, or controller it controls.
- An exception to this identification rule was also added, which will exempt an external disconnecting means that is mounted on the sign body, sign enclosure, sign pole, or controller.

Disconnecting means for a sign, outline lighting system, or controller is now required to be **marked to identify the sign**, outline lighting system, or controller it controls

Exception for external disconnect mounted on the sign body, sign enclosure, sign pole, or controller

Outdoor sign disconnecting means located remote from the sign

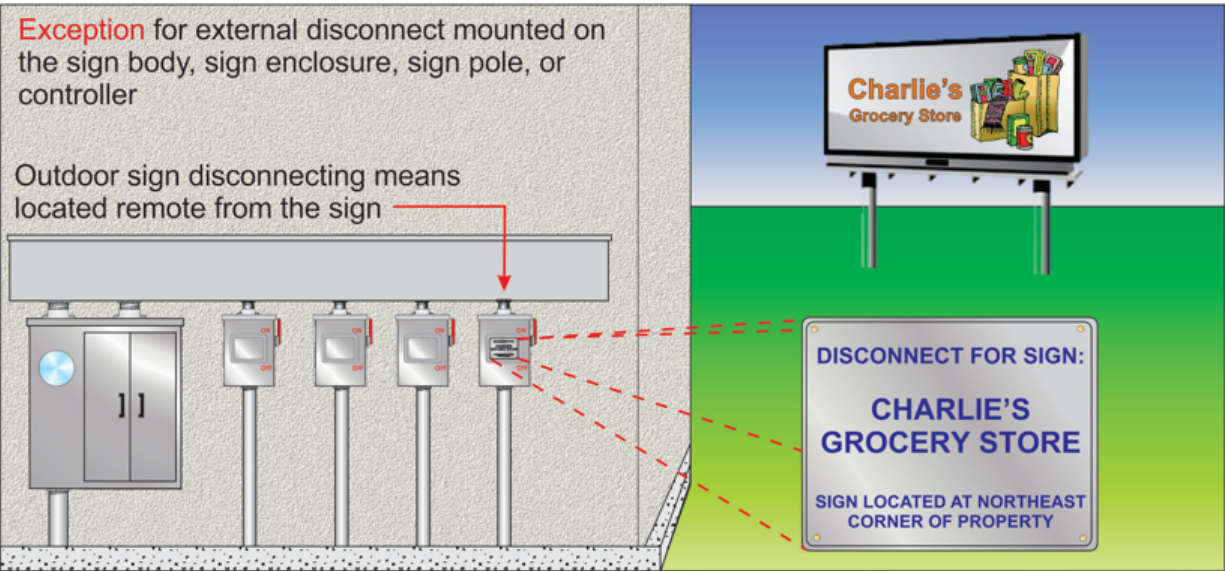

The disconnecting means (if located remote from the sign, sign body, or pole) shall be mounted at an **accessible location available to first responders and service personnel** [See 600.6(A)(4)]

620.6 GFCI Protection in Elevator Pits, Etc.

Change Type: Revision

- Revision clarifies that any receptacle in a pit must be GFCI protected.
- GFCI protection is not required for a hard-wired sump pump.

All 125-volt, single-phase, 15- and 20-ampere receptacle installed in pits, for hoistways, elevators, dumbwaiters, escalators, etc. are required to be of the GFCI receptacle type

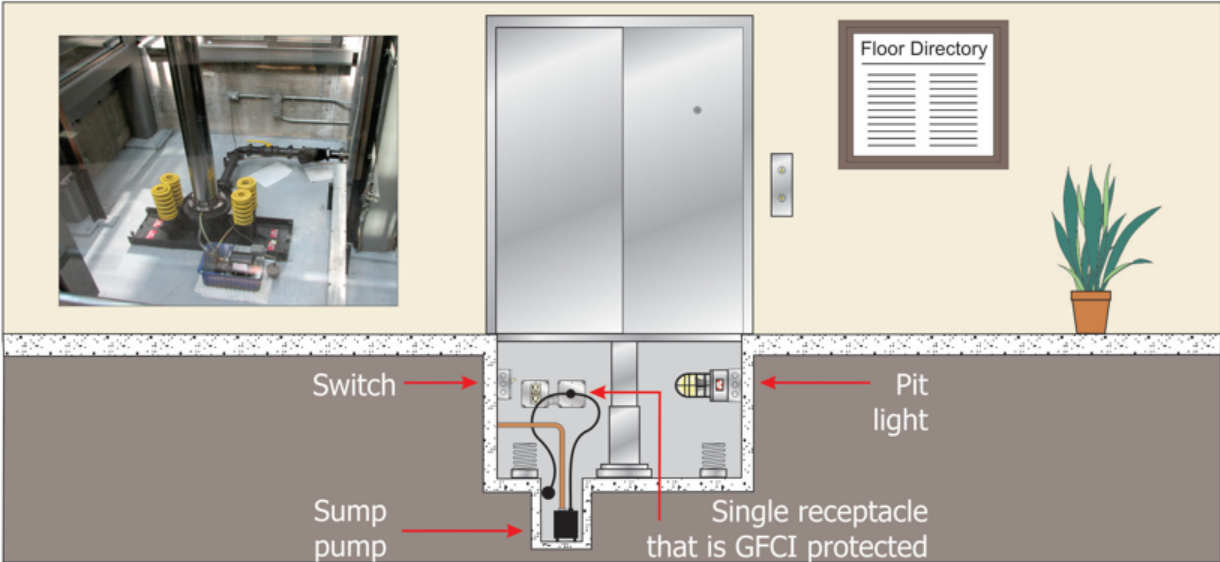

Permanently installed sump pumps required to be either **permanently wired** or must be supplied by a **single receptacle that is GFCI protected**

620.65 Signage for Selective Coordination (Elevators, Dumbwaiters, Escalators, Moving Walks, Platform Lifts, and Stairway Chairlifts)

Change Type: New

- New section added to require equipment enclosures for elevators, etc. containing selectively coordinated overcurrent devices to be legibly marked in the field.

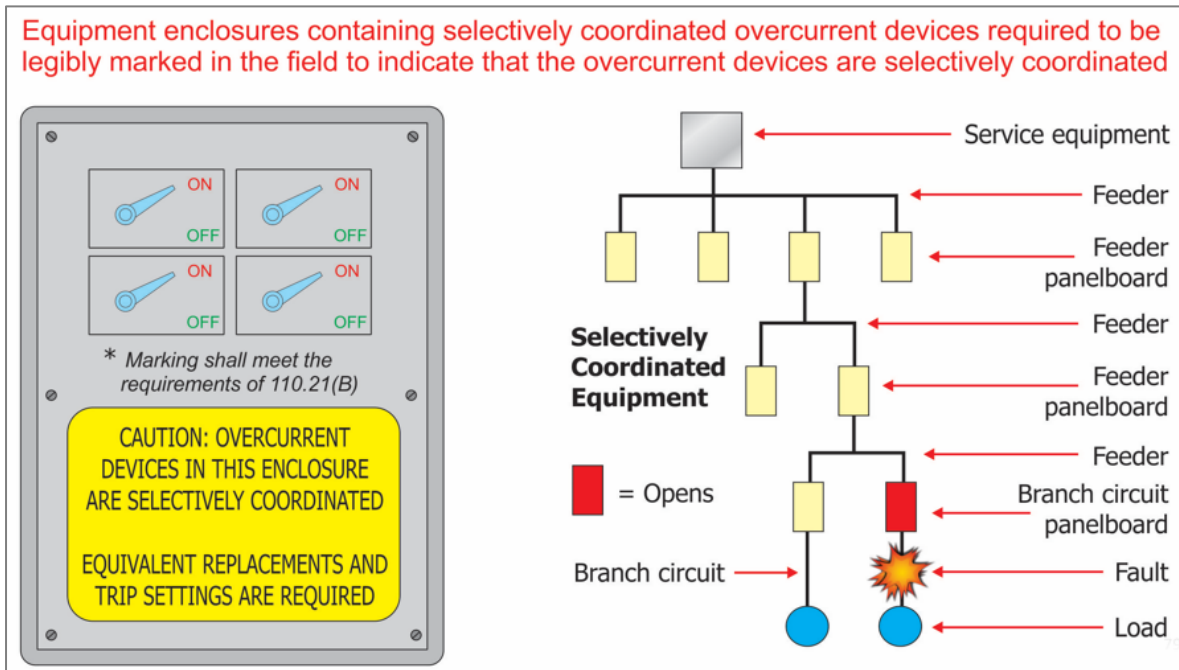

Article 625 and 625.1 Electrical Vehicle Charging Power Transfer Systems

Change Type: Revision

- Another significant change is being incorporated into Article 625 with the introduction of rules pertaining to power export equipment and bidirectional current flow equipment.
- The title of the article is being updated to “Electric Vehicle Power Transfer Systems” and the scope is being changed to reflect these revisions as well.

This article covers the electrical conductors and equipment **connecting** an electric vehicle to **premises wiring for the purposes of charging, power export, or bidirectional current flow.**

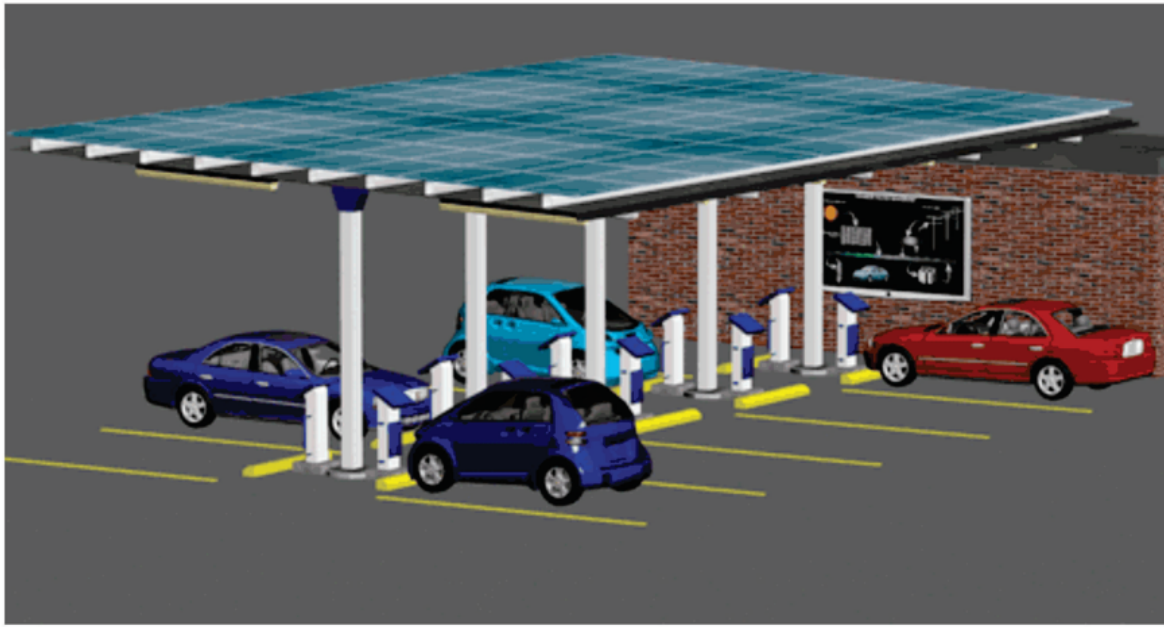

625.54 GFCI Protection for EV Charging Equipment

Change Type: New

- This revision clarifies that all receptacle outlets used for EV charging be provided with GFCI protection for personnel for all cord and plug connected electric vehicle power transfer equipment.

In addition to the requirements in 210.8, ***ALL*** receptacles installed for the connection of electric vehicle charging equipment is required to provide GFCI protection for personnel

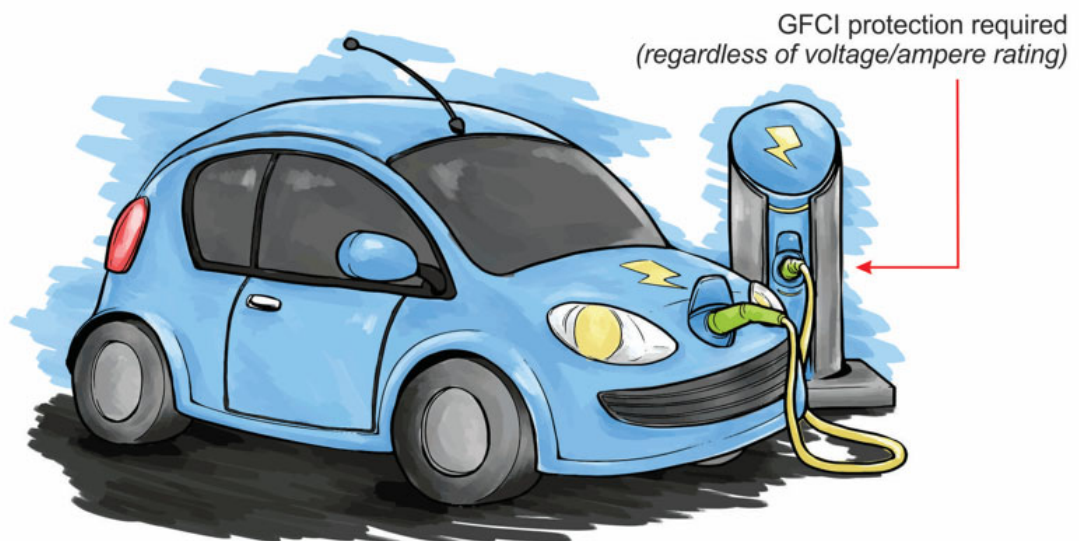

625.56 WP Enclosure for EV Charging Receptacle Outlets

Change Type:

- New requirement added to require all receptacles installed in a wet location for EV charging to be installed in an enclosure that provides weatherproof protection with or without an attachment plug cap inserted.

All receptacles installed in a wet location for electric vehicle charging require an enclosure that is weatherproof with the attachment plug cap inserted or removed



An outlet box hood installed for this purpose required to be listed and identified as "extra duty"
Other listed products, enclosures, or assemblies providing weatherproof protection (*not utilizing an outlet box hood*) shall not be required to be marked "extra duty"

680.2 and 680.14 Corrosive Environments.

Change Type:

- The definition of a “Corrosive Environment” was revised and relocated to 680.2.
- The listed and identified wiring methods for a corrosive environment are addressed at 680.14.

680.2 Definitions. (Swimming Pools, Fountains, and Similar Installations)

Corrosive Environment. Areas where pool sanitation chemicals are stored, handled, or dispensed, and confined areas under decks adjacent to such areas, as well as areas with circulation pumps, automatic chlorinators, filters, open areas under decks adjacent to or abutting the pool structure, and similar locations ~~shall be considered to be a corrosive environment.~~

680.2, 680.35, and 680.45 Immersion Pools

Change Type: New

- While the term “immersion” was contained in 3 definitions in Article 680, “Immersion Pools” were not specifically defined.
- Two new sections covering immersion pools were added to Article 680 providing installation requirements for a newly added definition at 680.2 for “Immersion Pools”:
 - New 680.35 was added for “Storable and Portable Immersion Pools”
 - New 680.45 was added for “Permanently Installed Immersion Pools”
- New definition added to 680.2 indicates that an immersion pool is “a pool for ceremonial or ritual immersion of users, which is designed and intended to have its contents drained or discharged”.

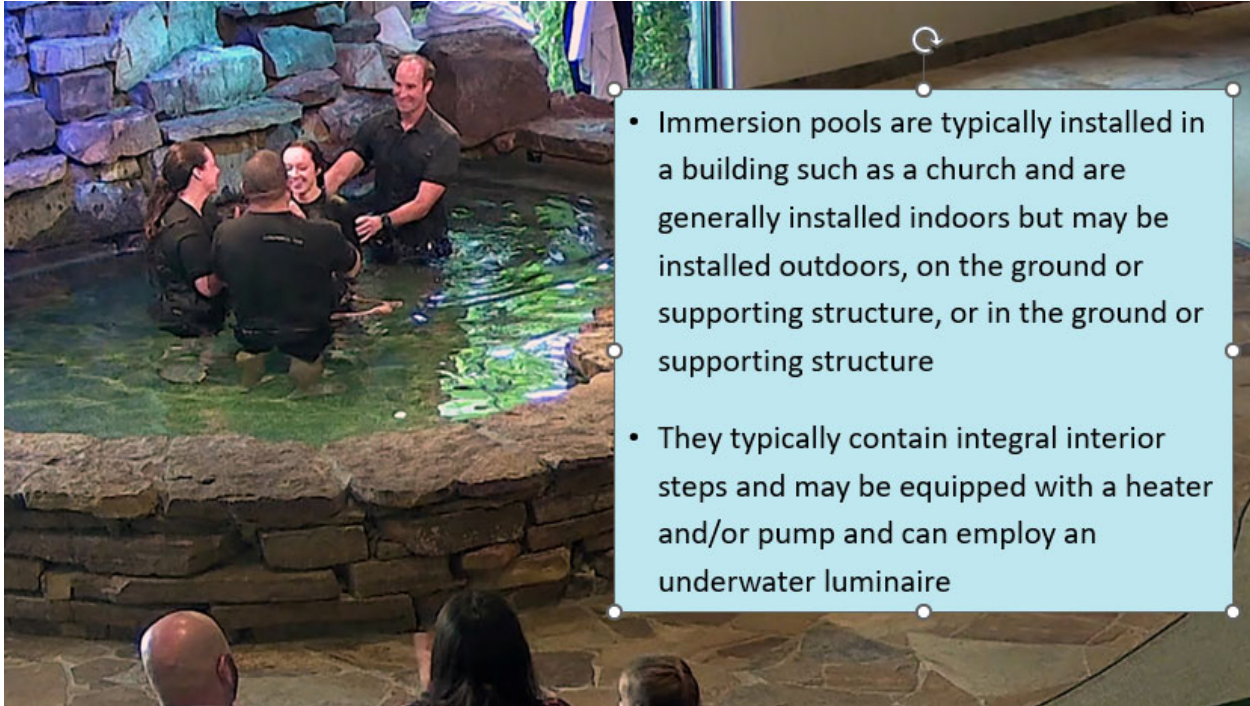

680.2 and 680.50 Splash Pads

Change Type: New

- A **new definition** for “**Splash Pads**” was added at **680.2** and provisions added at **680.50** to allow for future revisions to more accurately target installation requirements for these units.
- **Splash Pad.** “A fountain with a pool depth **25 mm (1 in.) or less**, intended for recreational use by pedestrians. This definition does not include showers intended for hygienic rinsing prior to use of a pool, spa, or other water feature”.
- Splash pads now required to comply with **Part II** (*permanently installed pools*) and equipotential bonding requirements.
- Splash pads and similar installations present the **same potential risk of electric shock** as do the areas around swimming pools, therefore similar **equipotential bonding** should be required.



680.11 Underground Wiring Around Swimming Pools

Change Type: Revision

- The underground wiring methods and restriction of 680.9 were revised into a list format with three list items added.
- List Item 680.11(A) now states that underground wiring within 1.5 m (5 ft) horizontally from the inside wall of the pool is permitted and then gives a list of wiring methods that are considered suitable for the conditions in these locations.
- Two new wiring methods were added to the list of acceptable wiring methods within this 1.5 m (5 ft) underground zone.
- List Item 680.9(B) states that underground wiring is not permitted under the pool unless this wiring is necessary to supply pool equipment as permitted by Article 680.
- The minimum burial depth cover requirements are provided at Table 300.5 [see 680.9(C)].

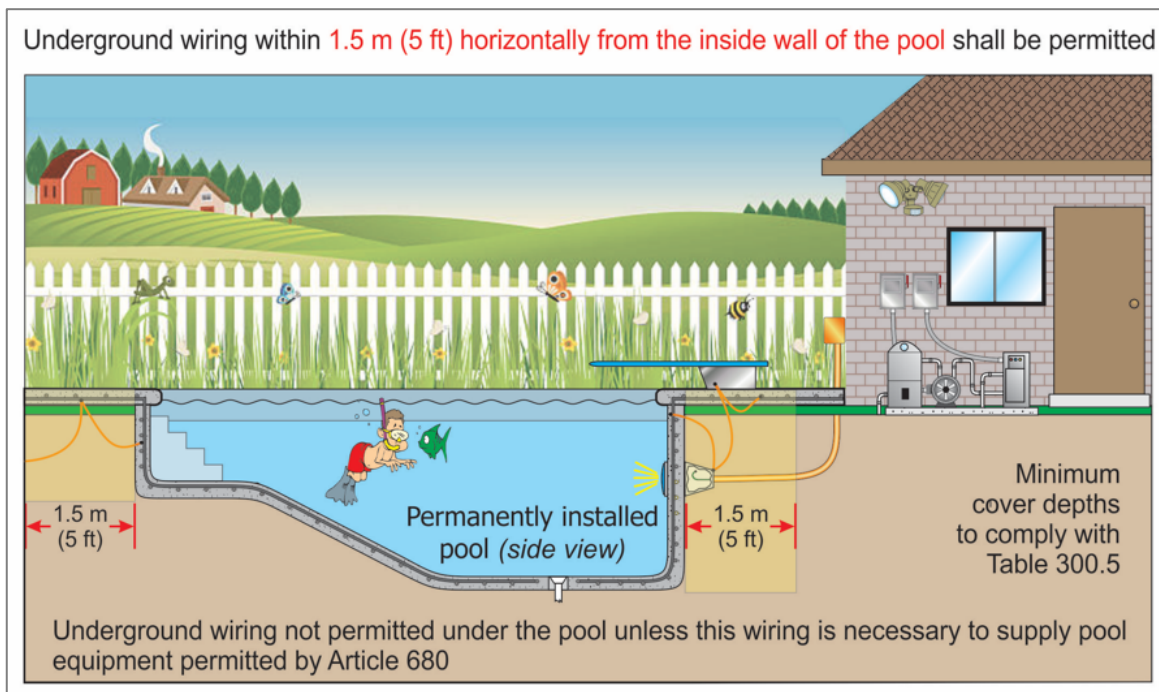

680.21(C) GFCI Protection for Motors

Change Type: New/Revision

- GFCI protection is applicable to all motors used in pool applications.
- An exception is added for listed low-voltage motors not requiring grounding.

Outlets supplying **all** pool motors on branch circuits rated 150 volts or less to ground and 60 amperes or less, single- or 3-phase, shall be provided with **Class A** GFCI protection



Exception permits **listed low-voltage motors** not requiring grounding (with ratings not exceeding the low-voltage contact limit) supplied by listed transformers or power supplies to be installed without GFCI protection

680.22(A)(5) Pool Equipment Room Receptacle

Change Type: New

- New provisions were added to require at least one GFCI-protected receptacle within a pool equipment room.
- All other receptacles in a pool equipment room now require GFCI protection as well.

At least one GFCI-protected 125-volt, 15- or 20- ampere receptacle on a general-purpose circuit required to be located within a pool equipment room

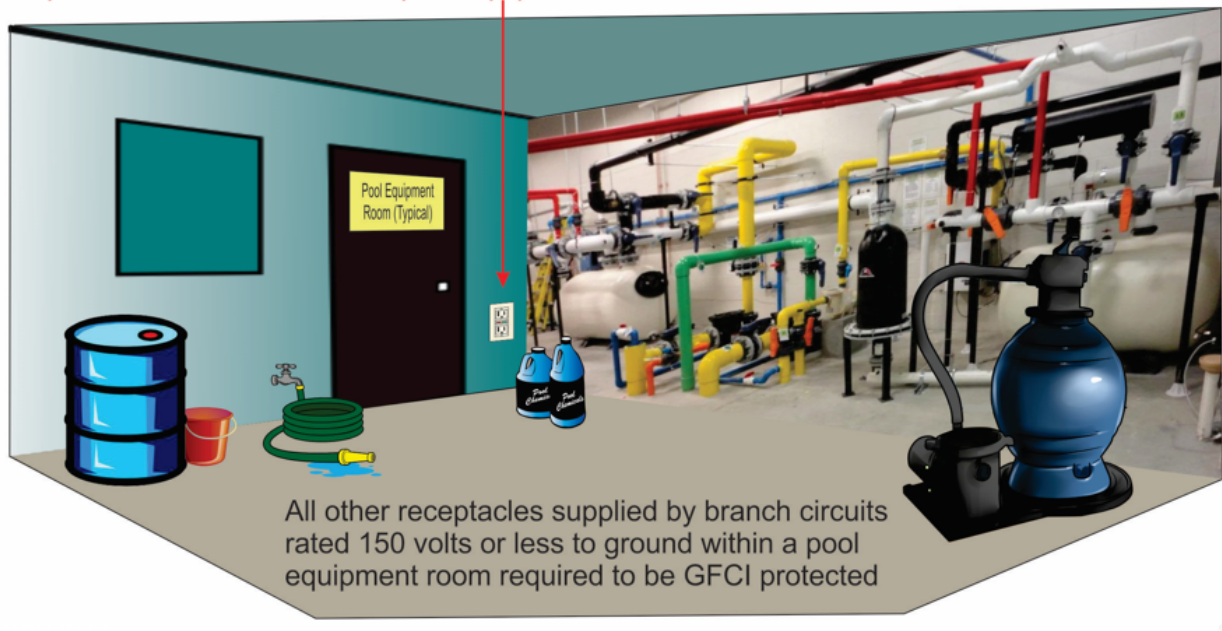

680.22(E) Other Equipment in Close Proximity to a Pool

Change Type: New

- Other equipment (other than traditional pool pump motors and controllers) are now required to generally be located at least 1.5 m (5 ft) horizontally from the inside walls of a pool.

Electrical equipment with ratings exceeding the low-voltage contact limit must be located at least **1.5 m (5 ft) horizontally from the inside walls of a pool** unless separated from the pool by a solid fence, wall, or other permanent barrier



680.59 GFCI Protection for Nonsubmersible Fountain Pumps

Change Type: New

- A new section is added to specifically address GFCI protection for nonsubmersible fountain pumps.

Outlets supplying all permanently installed nonsubmersible pump motors rated 250 volts or less and 60 amperes or less, single- or 3-phase, required to be provided with GFCI protection



680.84 Receptacles for Electrically Powered Pool Lifts

Change Type: Revision

- Provisions for **receptacles** for electrically powered pool lifts were added to 680.84 stating that these receptacles operating above the low-voltage contact limit must comply with **680.22(A)(3) and (A)(4)**.
 - Receptacles to be located not less than **1.83 m (6 ft)** from the inside walls of pools.
 - GFCI protection required for all 15- and 20-ampere, single-phase, 125-volt receptacles located **within 6.0 m (20 ft)** of the inside walls of pools.
- **2017 NEC Additions/Modifications for Pool Lifts – Reminders:**
 - 680.84 requires switches and switching devices that are operated above the low-voltage contact limit to comply with 680.22(C), which generally requires switches to be located at least **1.5 m (5 ft) horizontally** from the inside walls of a pool.



682.15 GFP for Natural and Artificially Made Bodes of Water

Change Type: Revision

- This revision organizes ground-fault protection into one location in Article 682.
- New provisions are added for GFP (not exceeding 30 mA) for feeder and branch circuit conductors installed on piers.

Outlets supplied by branch circuits not exceeding 150 volts to ground and 60 amperes, single-phase, shall be provided with **ground-fault circuit-interrupter (GFCI) protection** for personnel



Feeder and branch-circuit conductors installed on piers shall be provided with **ground-fault protection (GFP)** not exceeding 30 mA (*Coordination with downstream GFP permitted*)

682.33(C) Bonding of Equipotential Planes

Change Type:

- The parts specified in 682.33(C)(1) (Bonded Parts), 682.33(C) (2) (Outdoor Service Equipment and Disconnects), and 682.33(C)(3) (Walking Surfaces) are now required to be bonded together and to the electrical grounding system (grounding electrode system).
- The bonding conductors (there can be more than one) are required to be solid copper, insulated, covered or bare, and not smaller than 8 AWG.
- Connections from the equipotential plane to the grounding electrode system are required to be made by exothermic welding or by listed pressure connectors or clamps that are labeled as being suitable for the purpose and are of stainless steel, brass, copper, or copper alloy.

Revision made to 682.33(C) more clearly explains in more details as to what needs to be bonded together and how to bond each part in order to properly construct an equipotential plane

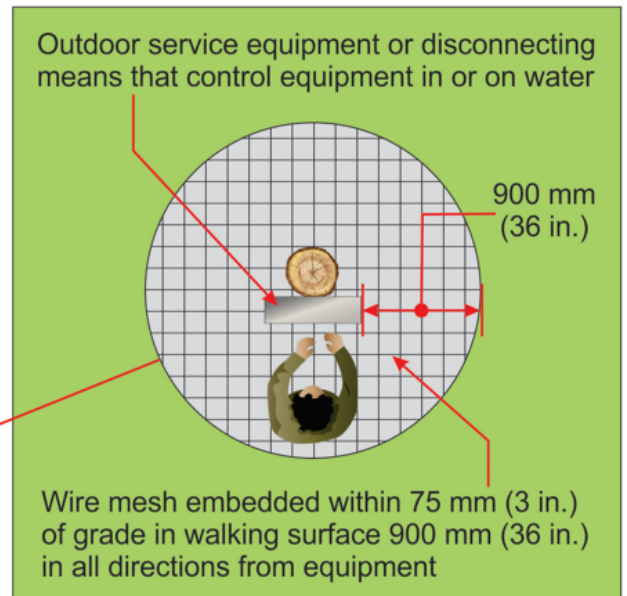

690.12 Rapid Shutdown of PV Systems on Buildings

Change Type: Revision

- The requirements for a Rapid Shutdown of PV systems received extensive revision again this *Code* cycle.
- A new product standard has been developed by UL so that hazardous energy levels within a PV array can be reduced when firefighters or other emergency response personnel are required to enter the array area to mitigate emergency conditions.

The rapid shutdown requirements of 690.12 were once again revised to emphasize that the primary purpose is to **reduce shock hazard for fire fighters**, and to align with new product standard **UL 3741** (Standard for Safety Photovoltaic Hazard Control)

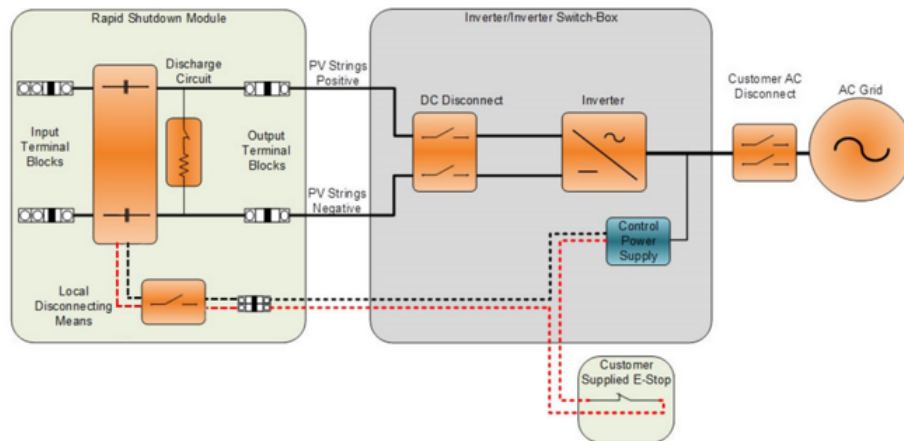

690.13(A) Photovoltaic System Disconnecting Means

Change Type: New

- This new requirement calls for any PV disconnect enclosure with a door or hinged cover that exposes live parts when open to be locked or require a tool to open where a disconnecting means of systems above 30 volts are readily accessible to unqualified persons.

PV system disconnecting means shall be installed at a readily accessible location



Where PV disconnecting means (above 30 volts) are readily accessible to unqualified persons, any enclosure door or hinged cover that exposes live parts when open is now required to be locked or require a tool to open

690.15 Disconnecting Means for Photovoltaic Equipment

Change Type: Revision

- The title was changed to “Disconnecting Means for Photovoltaic Equipment” with four subsections; (A) Location, (B) Isolating Device, (C) Equipment Disconnecting Means, and (D) Type of Disconnecting Means.
- This section was revised to emphasize that this section is intended to address isolation of equipment from energized conductors (isolated). This does not necessarily have to be accomplished by an equipment disconnecting means.



690.41(B) System Grounding [Solar Photovoltaic (PV) Systems], Ground-Fault Protection

Change Type: Revision

- PV system dc circuits (not just the arrays) that exceed 30 volts or 8 amperes are now required to be provided with dc ground-fault protection.
- This section now consists of three subsections; (1) Ground-Fault Detection, (2) Faulted Circuits, and new (3) Indication of Faults.



690.56(C) ID of Power Sources for Buildings with Rapid Shutdown

Change Type: Revision

- The parent text of 690.56(C) was revised with the previous text of 690.56(C)(1) added to this parent text.
- One figure remains with the title of the remaining figure changed to identify this figure as an informational note figure to clarify that the label as shown is merely an example of a rapid shutdown system label.
- The previous language of 690.56(C)(2) (*Buildings with More Than One Rapid Shutdown Type*), was relocated to 690.56(C)(1).
- The language at previous 690.56(C)(3) (*Rapid Shutdown Switch*) is now 690.56(C)(2).

Buildings with PV systems shall have a permanent label located at each service equipment location to which the PV systems are connected or at an approved readily visible location and shall indicate the location of rapid shutdown initiation devices

Information Note Figure 690.56(C): Label for Roof-Mounted PV Systems with Rapid Shutdown

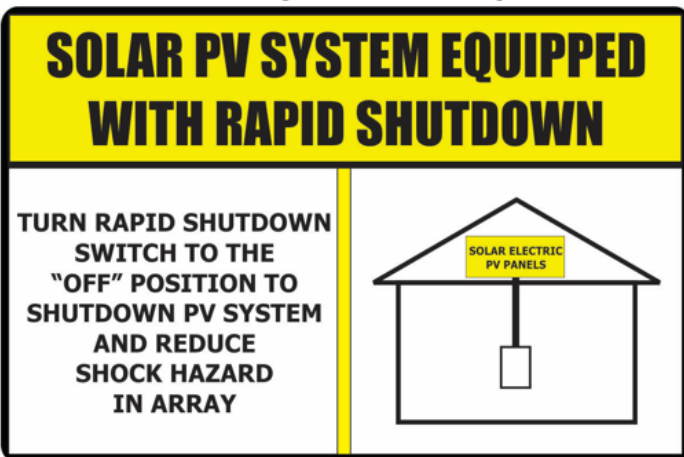

Label required by 690.56(C)(2)

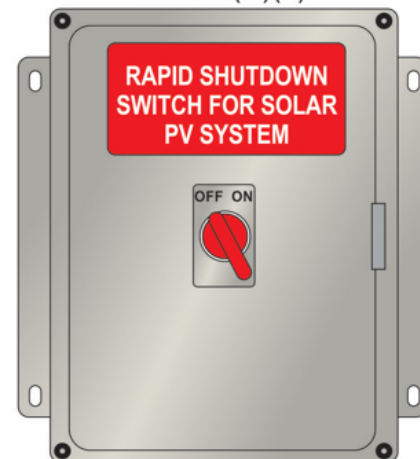

Title of remaining figure has been changed to identify this figure as an informational note figure to clarify that the label as shown is merely an **example of a rapid shutdown system label**

695.6(J) Raceway Terminations

Change Type: Revision

- Revisions were made to align the allowable wiring methods in 695.6(D) with the required terminations fittings at a fire pump controller.
- Cable fittings that are listed for the wiring method used and with a type rating at least equal to that of the fire pump controller are appropriate for these installations.

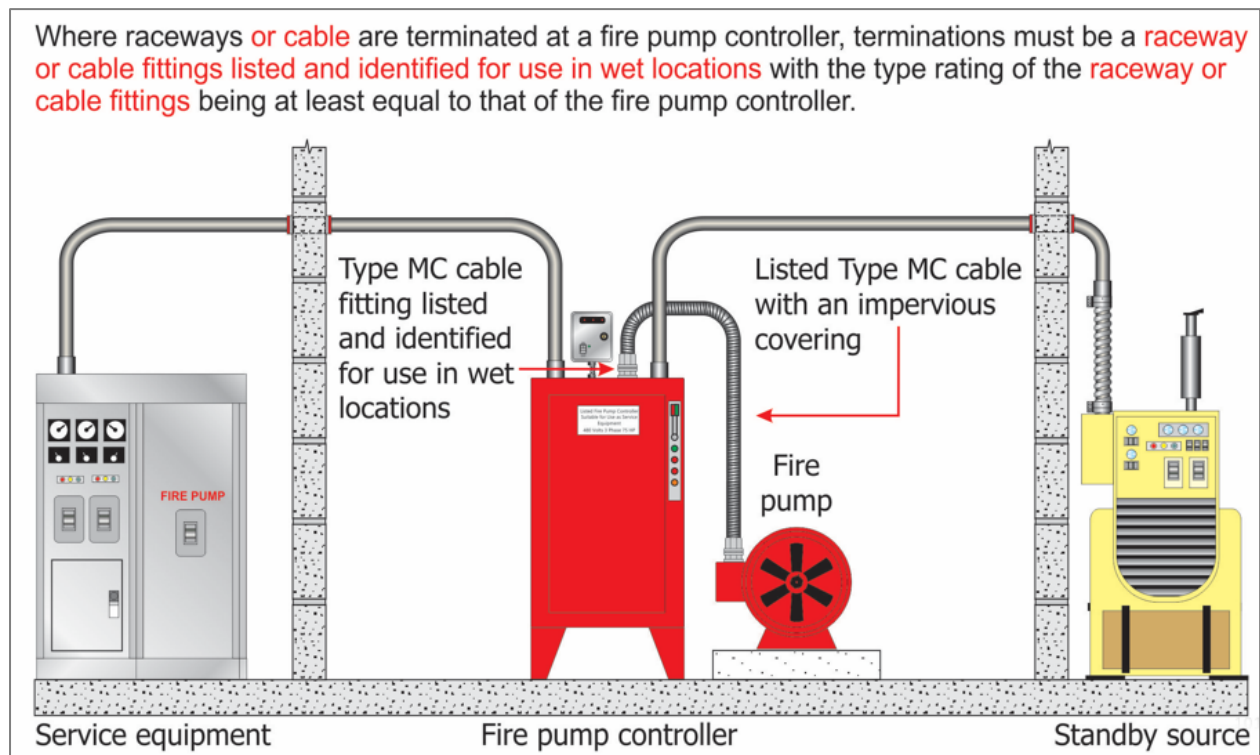

700.5(A) Emergency Systems Transfer Equipment

Change Type: New

- A new last sentence is added to clarify that meter mounted transfer switches are not permitted for use in emergency systems.

Transfer equipment (including automatic transfer switches) shall be automatic, identified listed, and marked for emergency use

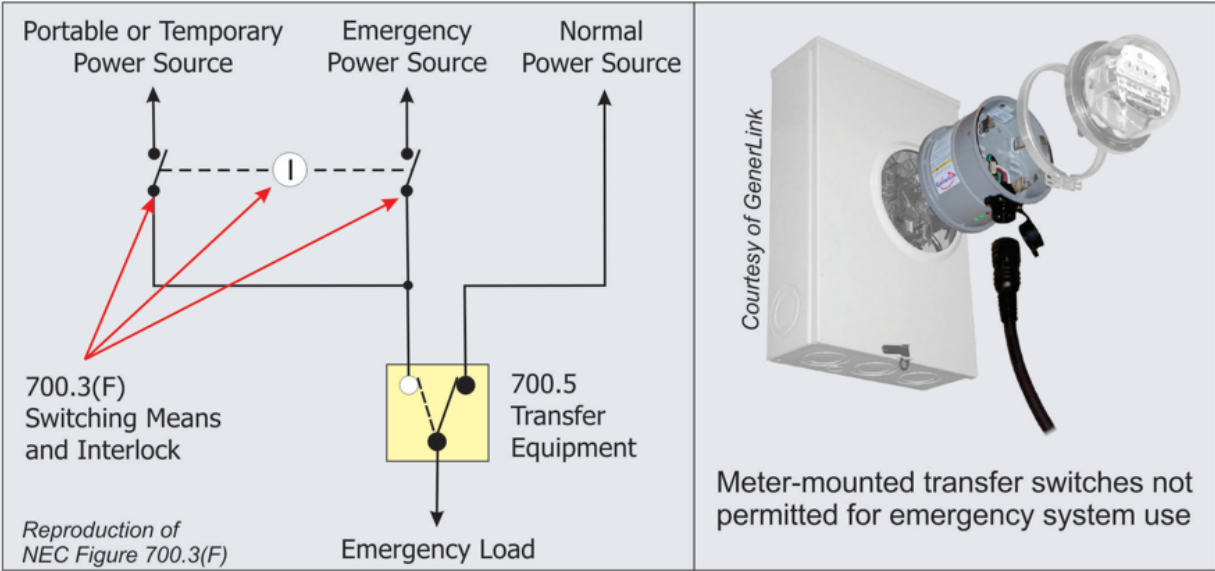

700.12(B) Emergency System Equipment Design and Location

Change Type: New/Revision

- The reference to spaces with a 1-hour fire rating is revised to 2-hour, to correlate with the requirements of 700.10(D) and NFPA 110.
- Previous List item (3) addressing “health care occupancies where persons are not capable of self-preservation” was deleted to resolve conflicts between this section and NFPA 99.

Equipment for sources of power required to be installed either in spaces fully protected by approved automatic fire **protection systems** or in spaces with a **2-hour** fire rating where located within:

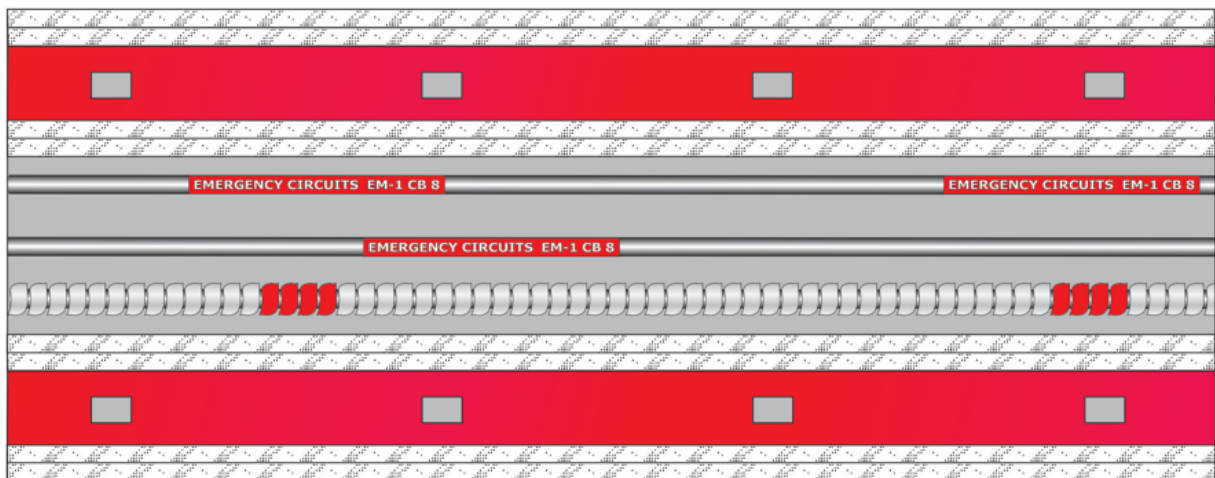

(1) Assembly occupancies for more than 1000 persons, (2) Buildings above 23 m (75 ft) in height with any of the following occupancy classes; assembly, educational, residential, detention and correctional, business, and mercantile, ~~(3) Health care occupancies where persons are not capable of self-preservation;~~ and (3) Educational occupancies with more than 300 occupants ¹⁰⁹

702.7(A) Sign for On-Site Optional Standby Systems

Change Type: New

- A sign is required to be placed at the residential emergency disconnecting means required by 230.85 that indicates the location of each permanently installed on-site optional standby power source disconnect.
- This same requirement would apply to an on-site optional generator to identify the shutdown means of the prime mover as required in 445.18(D).

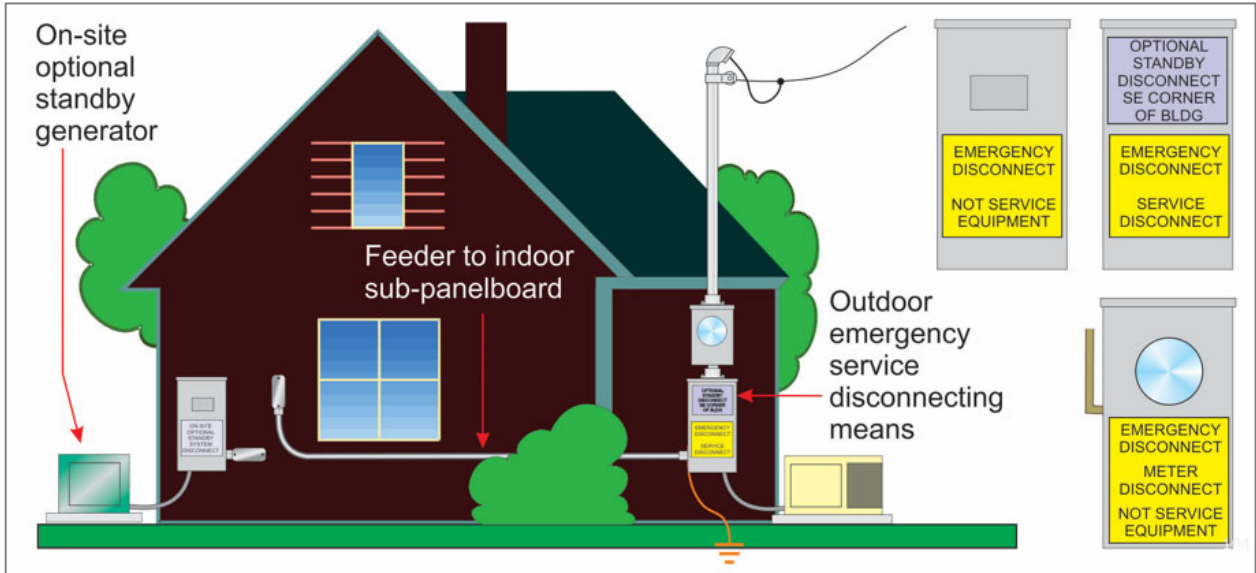

Article 705 Interconnected Electric Power Production Sources

Change Type: Revision/New

- Article 705 was extensively reorganized and revised for this Code cycle.
- Article 705 (Interconnected Electric Power Production Sources) still covers installation of one or more electric power production sources operating in parallel with a primary source(s) of electricity.
- The article has been revised and now contains (2) Parts; Part I-General and Part II-Microgrid Systems.

Article 705 covers installation of one or more electric power production sources operating in parallel with a primary source(s) of electricity

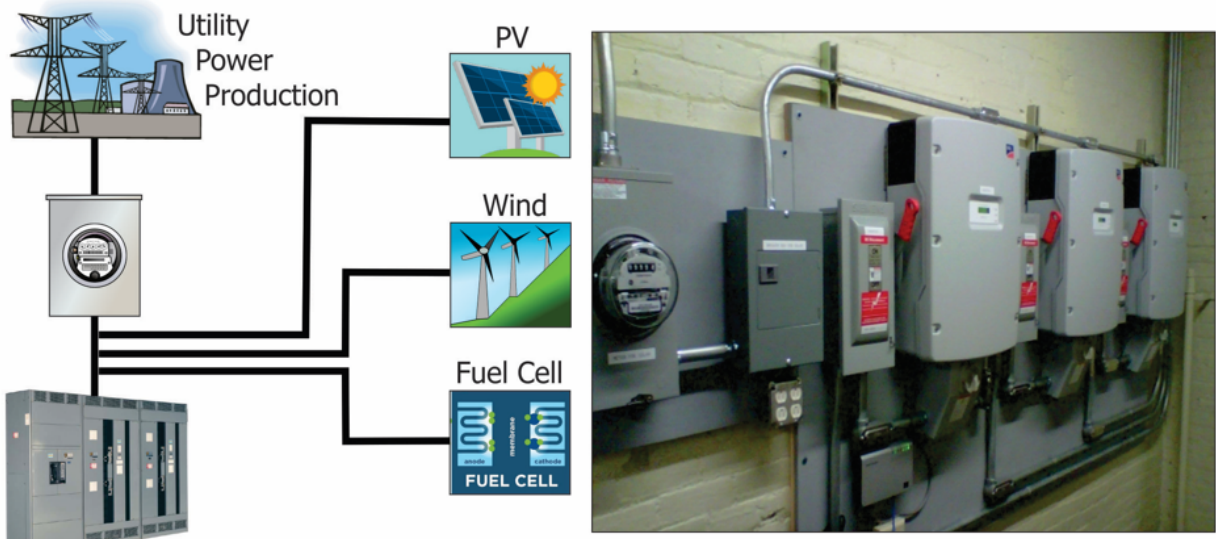

The diagram illustrates the interconnected electric power production sources covered by Article 705. It shows a central electrical panel (circuit breaker) connected to four different power production sources: Utility Power Production (represented by a power line tower and a power plant), PV (represented by solar panels), Wind (represented by wind turbines), and Fuel Cell (represented by a fuel cell unit). The photograph shows a real-world installation of these components, including a meter, a circuit breaker, and a fuel cell unit.

Article 705 was extensively reorganized and revised for the 2020 *NEC* Code cycle

706.2 Definitions: Energy Storage System (ESS)

Change Type: Revision

- Revisions to the previous definition of an **Energy Storage System (ESS)** better define what an ESS is and is not.
- **Energy Storage System (ESS)**. “One or more components assembled together capable of storing energy and providing electrical energy into the premises wiring system or an electric power production and distribution network”.
- The **different classifications** of ESS that were in the 2017 *NEC* were **deleted** as these terms are no longer used in the ESS industry.
- **UL 9540** (*Standard for Energy Storage Systems and Equipment*) does not specify or define any specific system classification terminology.
- Improvements to the definition of an energy storage system will help users of the *Code* better apply Article 706 to electrical installations.

706.9 Maximum Voltage (Energy Storage Systems)

Change Type: New

- New section added to provide prescriptive requirements for the determination of maximum voltage of an ESS.

The maximum voltage of an ESS is determined by the rated ESS input and output voltage(s) indicated on the ESS nameplate(s) or system listing.

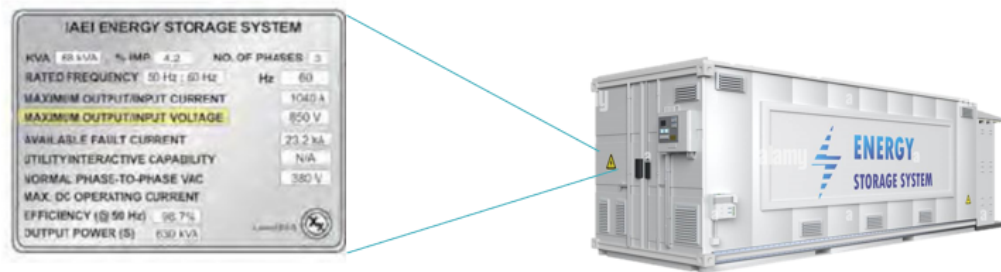

706.30(A)(1) Nameplate-Rated Circuit Current (ESS)

Change Type: Revision

- This revision clarifies that an ESS may have two nameplates, each respectively indicating input or output circuit rating, or one nameplate showing input and output circuit ratings.

Circuit current is the rated current indicated on an energy storage system (ESS) nameplate(s) or system listing ~~for pre-engineered or self-contained systems of matched components intended for field assembly as a system~~



Where an ESS has separate input (charge) and output (discharge) circuits or ratings, these ratings are to be **considered individually** (possibly two nameplates)

Where the same terminals on the ESS are used for charging and discharging, the rated current would be considered the **greater of the two.**

760.121(B) Power Sources for PLFA Circuits (*Fire Alarm Systems*)

Change Type: Revision

- New sentence added to permit the fire alarm branch-circuit disconnecting means for power limited fire alarm (PLFA) circuits to be **secured in the “on” position.**
- The fire alarm circuit disconnect for non-power-limited fire alarm (NPLFA) circuits was already permitted to be secured in the “on” position [see 760.41(A)].
- Change provides consistency with NPLFA circuits and PLFA circuits.
- While this practice was not prohibited by **760.121**, it was not specifically permitted either.
- Installing **breaker locks** is already a common industry practice on fire alarm circuits.



2021 Virginia Plumbing Code

202 – Definitions – Copper Alloy

Change Type: **Addition**

- The addition of this definition to the code is a simple clarification to support the use of the term “copper alloy” throughout the code
- Long ago, the term for alloys of copper used in the plumbing industry was “brass” (e.g., typically red brass or yellow brass). However, brasses are only one group of a wider array of copper alloys that a manufacturer might wish to use for products



Copper Alloy A metal alloy where the principal component is copper.

Copper Alloy – Unified Numbering System (UNS)

Wrought Products

C100xx-C150xx Cu Commercially Pure Copper

C151xx-C199xx Age Hardenable Cu (w/ Cd, Be, Cr, Fe)

C2xxxx Cu-Zn alloys Brasses

C3xxxx Cu-Zn-Pb alloys Leaded brasses

C4xxxx Cu-Zn-Sn alloys Tin bronzes

C5xxxx Cu-Sn and Cu-Sn-Pb Phosphor bronze alloys

C6xxxx Cu-Al and Cu-Si Bronzes

C7xxxx Cu-Ni Copper Nickel and Cu-Ni-Zn Nickel Silver

Cast Products

C800xx-C811xx Commercially Pure Coppers

C813xx-C828xx 95-99% Copper

C833xx-C899xx Cu-Zn alloys containing Sn, Pb, Mn, or Si

C9xxxx Other alloys, including tin bronze, aluminum bronze, copper nickel

202 – Definitions – Public and Private

Change Type: Clarification

PUBLIC OR PUBLIC UTILIZATION. In the classification of plumbing fixtures, “public” applies to fixtures with unrestricted exposure to walk-in traffic

PRIVATE. In the classification of plumbing fixtures, “private” applies to fixtures that are not public

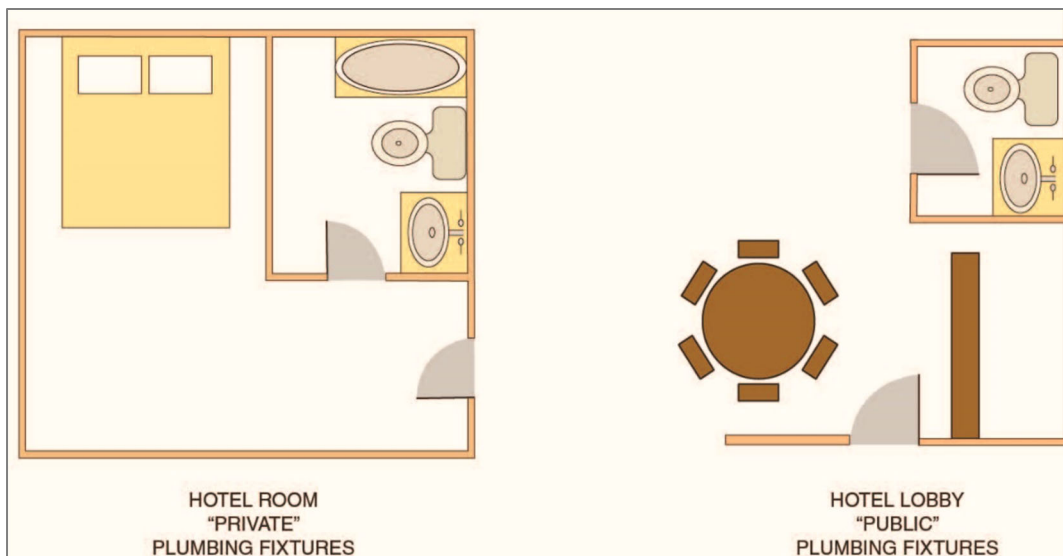

The overarching scope of this change was to reduce the growth of Legionella.

Per the proposal’s reason statement, Legionella reproduces at the highest rates in the range of 85-110°F, which is the water temperature required for public lavatories. Given this, the proponents sought to change the definition of public vs private fixtures to limit the number of public lavatories.

Public or public utilization is a descriptor for toilet facilities that are available to the general public or anyone who enters a building. Employee plumbing fixtures are considered to be public fixtures unless their use is restricted to an individual (or family) such as those located off of a private office.

202 – Modified *Water Dispenser* definition specifically excludes dispensers not connected to the potable water distribution system

- Water coolers and similar devices not connected to the potable water distribution system of the premises are no longer considered “Water Dispensers”

Water Dispenser A plumbing fixture that is manually controlled by the user for the purpose of dispensing potable drinking water into a receptacle such as a cup, glass or bottle. Such fixture is connected to the potable water distribution system of the premises ~~This definition includes a freestanding apparatus for the same purpose that is not connected to the potable water distribution system and that is supplied with potable water from a container, bottle or reservoir~~

- **Section 410.4 Substitution** uses the term “water dispenser” concerning substitution for drinking fountains

410.4 Substitution Where restaurants provide drinking water in a container free of charge, drinking fountains shall not be required in those restaurants. In other occupancies where three or more drinking fountains are required, water dispensers shall be permitted to be substituted for not more than 50 percent of the required number of drinking fountains.

- The definition change results in the elimination of bottled water units and other self-contained potable water dispensing apparatus as a code-sanctioned alternative to some quantity of drinking fountains

308.9 Parallel Water Distribution Systems

Change Type: Modification

- Where hot water piping for a manifold system is in a bundle with cold water piping, the hot water piping is required to be insulated but not necessarily individually insulated
- The bundling of piping from manifold systems is often required very near the manifold. Individually insulating each hot water pipe (tube) in these bundles results in very large openings needed in framing members for the bundles to pass through. In those situations, the bundle of hot water piping can be insulated
- The reference to Section 607.5 directs the code user to the requirements for pipe insulation

308.9 Parallel water distribution systems. Piping bundles for manifold systems shall be supported in accordance with Table 308.5. Support at changes in direction shall be in accordance with the manufacturer's instructions. Where hot water piping is bundled with cold or hot water piping, each hot water pipe piping shall be insulated in accordance with Section 607.5.

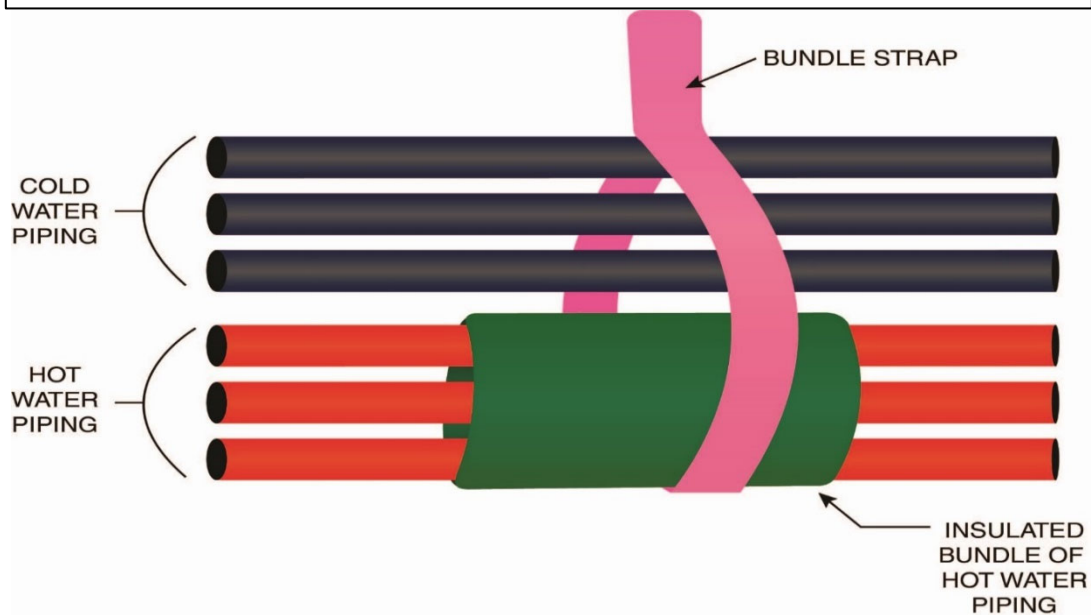

403.3.1, 403.5 Facilities and Drinking Fountains on Accessible Routes

Change Type: Clarification

- Because accessibility is covered by Section 404 which includes specifics concerning accessible routes, the accessible route language has been removed from 403.3.1 and 403.5
- **This clarification does not remove the requirement for toilet facilities and drinking fountains to be on accessible routes**
- Section 404 already properly covers this matter by referring to the *International Building Code* where Chapter 11 has full details (along with exceptions) about where accessible routes are and are not needed

403.3.1 Access. The route to the public toilet facilities required by Section 403.3 shall not pass through kitchens, storage rooms or closets. Access to the required facilities shall be from within the building or from the exterior of the building. ~~Routes shall comply with the accessibility requirements of the International Building Code.~~ The public shall have access to the required toilet facilities at all times that the building is occupied.

403.5 Drinking fountain location. Drinking fountains shall not be required to be located in individual tenant spaces provided that public drinking fountains are located within a distance of travel of 500 feet (152 m) of the most remote location in the tenant space and not more than one story above or below the tenant space. Where the tenant space is in a covered or open mall, such distance shall not exceed 300 feet (91 m). ~~Drinking fountains shall be located on an accessible route.~~

403.6 Service Sink Location

Change Type: Addition

- Where a service sink is not located within a tenant space in a covered mall, the travel distance to a service sink is limited

403.6 Service sink location.

Service sinks shall not be required to be located in individual tenant spaces in a covered mall provided that service sinks are located within a distance of travel of 300 feet (91 m) of the most remote location in the tenant space and not more than one story above or below the tenant space. Service sinks shall be located on an accessible route.

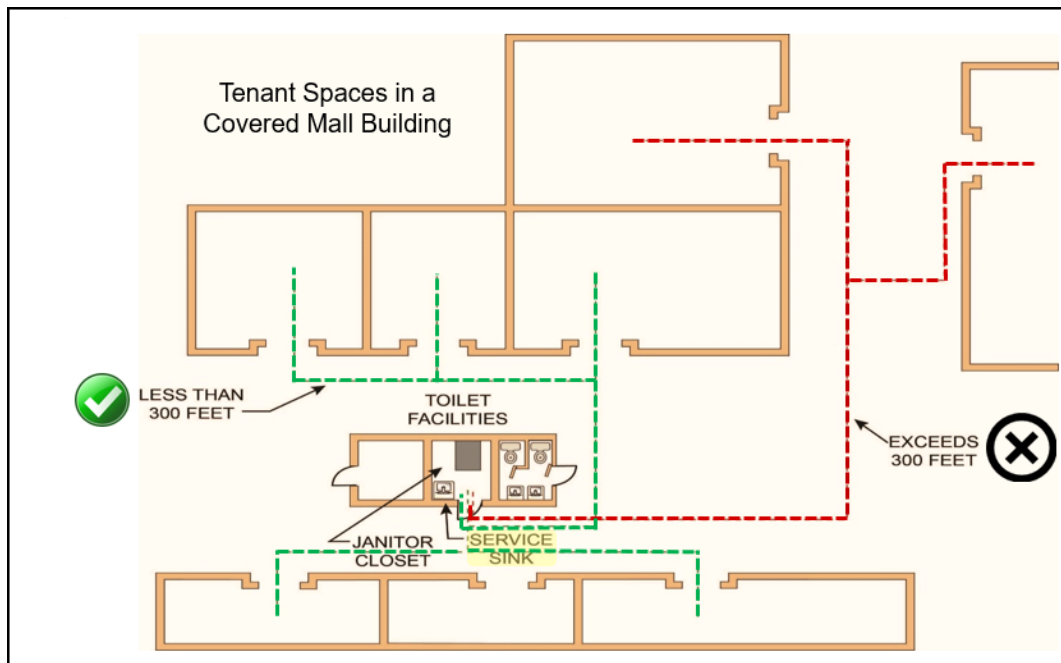

405.4.3 Wall Hung Fixture Carrier Standard for Water Closets

- This **modification** adds a new standard for carriers for wall-mounted (“wall-hung”) water closets: ASME A112.6.1M or ASME A112.6.2

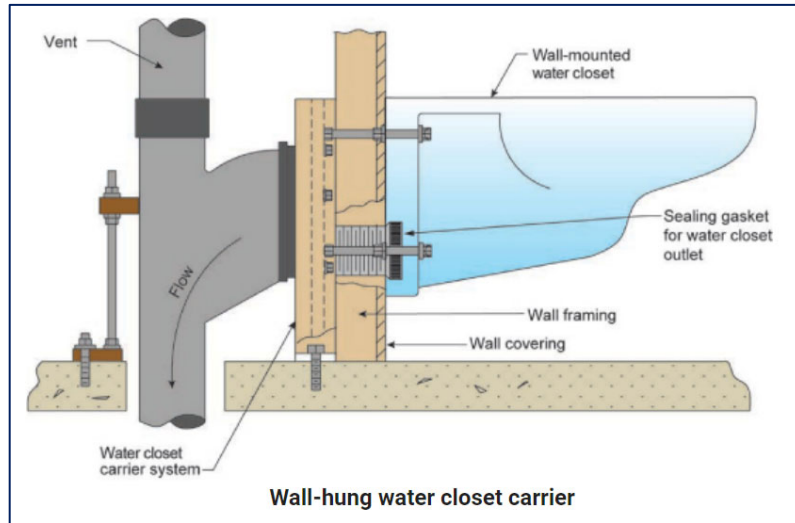

407.2 Bathtub Overflow Outlets Now Optional (modification)

407.2 Bathtub waste outlets and overflows. Bathtubs shall be equipped with a waste outlet ~~and an overflow outlet~~. The outlets ~~shall be connected to waste tubing or piping~~ that is not less than 1½ inches (38 mm) in diameter. The waste outlet shall be equipped with a watertight stopper. Where an overflow is installed, the overflow shall be not less than 1½ inches (38 mm) in diameter.

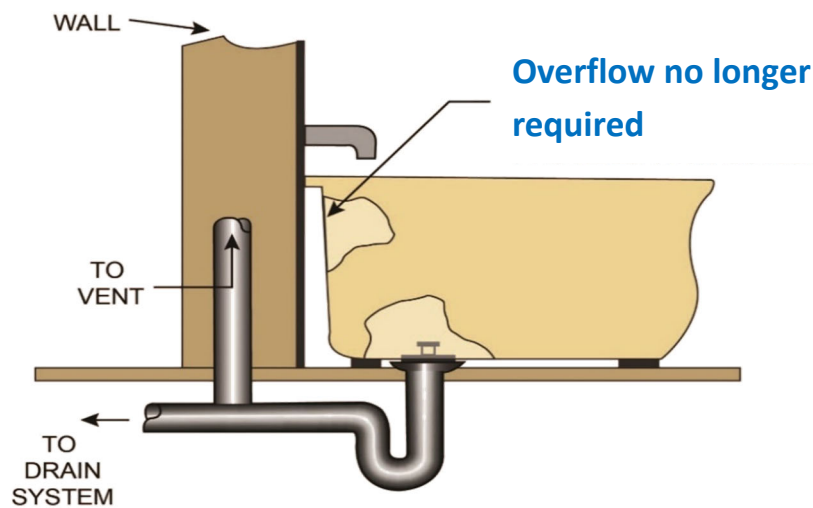

410.3 Quantities of Standing versus Wheelchair Drinking Fountains

Change Type: Addition

- Language is added to align with the VCC/IBC requirements for accessible drinking fountains to ensure these requirements aren't overlooked
- 50 percent of the required number of drinking fountains must be for standing persons and the other 50 percent for persons who use a wheelchair

410.3 High and low drinking fountains. Where drinking fountains are provided on an exterior site, on a floor or within a secured area, the drinking fountains shall be provided in accordance with Sections 410.3.1 and 410.3.2.

410.3 410.3.1 High and low drinking fountains-Minimum number. ~~Where drinking fountains are required,~~ Not fewer than two drinking fountains shall be provided. One drinking fountain shall comply with the requirements for people who use a wheelchair and one drinking fountain shall comply with the requirements for standing persons.

Exceptions:

(see full code text)

410.3.2 More than the minimum number. Where more than the minimum number of drinking fountains specified in Section 410.3.1 is provided, 50 percent of the total number of drinking ountains provided shall comply with the requirements for persons who use a wheelchair and 50 percent of the total number of drinking fountains provided shall comply with the requirements for standing persons.

Exceptions:

(see full code text)

411.3 Emergency Showers and Eye Wash Stations Water Supply

Change Type: Modification

- Emergency shower stations and eyewash stations need precise temperature controls, and the water discharge is also needed quickly
- A water heater complying with **ASSE 1085** has the necessary control technology to reliably provide water at the intended temperature for these applications

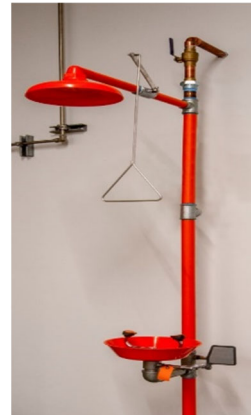

411.3 Water Supply Where hot and cold water is supplied to an emergency shower or eyewash station, the temperature of the water supply shall only be controlled by a temperature actuated mixing valve complying with ASSE 1071. Where water is supplied directly to an emergency shower or eyewash station from a water heater, the water heater shall comply with ASSE 1085.

412.3 & 412.4 Shower Control Valves to be Rated for the Installed Shower Head

Change Type: Modification

- Lower flow shower heads need to be compatible with the shower control (mixing valve)
- This ensures there is enough flow to allow the valve to self-adjust to prevent temperature shock to the user when a supply pressure or temperature change occurs
- New text added to **412.4 Multiple (gang) showers** requires that *access* be provided to ASSE 1069 or CSA B125.3 valves

412.5 Methods for Limiting Water Temperature Discharged to Bathtubs

Change Type: Modification



- Two new types of water heaters are available that have the necessary control technology to reliably provide water at the intended (maximum) temperature for this application
- Freestanding bathtub faucets (floor mounted) have become available that have an integral temperature limiting device that complies with the test requirement of standard ASSE 1070/ASME A112.1070/CSA B125.70
- **Where one of these new methods is used, an external temperature limiting device is not needed**
- Text is also added specifying that **access** must be provided to temperature limiting valves

412.5 Bathtub and whirlpool bathtub valves. ~~The hot water supplied to Bathtubs and whirlpool bathtub valves shall be limited to not greater than~~ have or be supplied by a water-temperature-limiting device that conforms to ASSE 1070/ASME A112.1070/CSA B125.70 or by a water heater complying with {ASSE 1082} or {ASSE 1084}, except where such protection is otherwise provided by a such valves are combination tub/shower valves in accordance with Section 412.3. The water-temperature-limiting device required by this section shall be equipped with a means to limit the maximum setting of the device to 120°F (49°C), and, where adjustable, shall be field adjusted in accordance with the manufacturer's instructions to provide hot water at a temperature not to exceed 120°F (49°C). Access shall be provided to water-temperature-limiting devices that conform to ASSE 1070/ASME A112.1070/CSA B125.70.

Exception: Access shall not be required for nonadjustable water-temperature-limiting devices that conform to ASSE 1070/ASME A112.1070/CSA B125.70 and are integral with a fixture fitting, provided that the fixture fitting itself can be accessed for replacement.

412.10 and 423.3 Methods for Temperature Limitation at Head Shampoo Sinks and Footbaths

Change Type: Modification

- 412.10 adds two new options for regulating the maximum temperature of **head shampoo** sink faucets:
 1. A limiting device conforming to ASSE 1070/ASME A112.1070/ CSA B125.70
 2. A water heater conforming to ASSE 1082
 3. A temperature-actuated, flow-reduction device conforming to ASSE 1062
- Water heater complying with ASSE 1082 is also added as an option for water supplied to **footbaths and pedicure baths at 423.3**

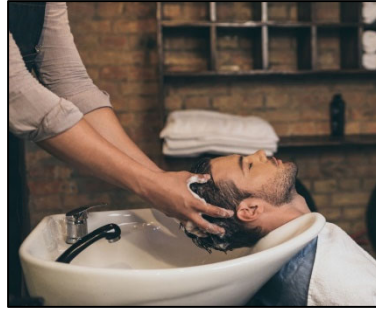

412.10 Head shampoo sink faucets. Head shampoo sink faucets shall be supplied with hot water that is limited to not more than 120°F (49°C) ~~by a water-temperature-limiting device that conforms to ASSE 1070/ASME A112.1070/CSA D125.70.~~ Each faucet shall have integral check valves to prevent crossover flow between the hot and cold water supply connections. The means for regulating the maximum temperature shall be one of the following:

1. A limiting device conforming to ASSE 1070/ASME A112.1070/ CSA B125.70.
2. A water heater conforming to ASSE 1082.
3. A temperature-actuated, flow-reduction device conforming to ASSE 1062.

423.3 Footbaths and pedicure baths. The water supplied to specialty plumbing fixtures, such as pedicure chairs having an integral foot bathtub and footbaths, shall be limited to not greater than 120°F (49°C) by a water-temperature-limiting device that conforms to ASSE 1070/ASME A112.1070/CSA B125.70 or ~~CSA D125.3~~ by a water heater complying with ASSE 1082.

419.5 Tempered Water for Public Hand-Washing Facilities

Change Type: Modification

- A valve conforming to CSA B125.3 is no longer acceptable as a water-temperature limiting device for public hand-washing lavatories

419.5 Tempered water for public hand-washing facilities. Tempered water shall be delivered from lavatories and group wash fixtures located in public toilet facilities provided for customers, patrons and visitors. Tempered water shall be delivered through an approved water-temperature limiting device that conforms to ASSE 1070/ ASME A112.1070/CSA B125.70 ~~or CSA D125.3.~~

421.3.1 Standard for Shower Waste Fittings

Change Type: Addition

- Shower drains, including linear shower drains, are required to comply with the referenced standard
- The latest edition of ASME A112.18.2/CSA B125.2 contains specific requirements for typical shower drains, linear type drains and built-up shower drain systems that are normally used in field fabricated shower systems



421.3.1 Waste fittings. Waste fittings shall conform to ASME A112.18.2/CSA B125.2.

501.2 Water Heater as a Space Heater

Change Type: Clarification

- The term “master” was confusing to some designers and installers as ASSE 1017 doesn’t refer to that type of mixing valve. The standard indicates the acceptable location where such mixing valves are intended: at the source of hot water and not at a point-of-use



501.2 Water heater as space heater. Where a combination potable water heating and space heating system requires water for space heating at temperatures greater than 140°F (60°C), a ~~master~~ **thermostatic temperature-actuated** mixing valve complying with ASSE 1017 shall be provided to limit the water supplied to the potable hot water distribution system to a temperature of 140°F (60°C) or less. The potability of the water shall be maintained throughout the system. **Requirements for combination potable water heating and space heating systems shall be in accordance with the International Mechanical Code.**

602.3.5 Potable Water Pumps to Comply with NSF 61

Change Type: Modification

- Now that most manufacturers have pumps that comply with this standard, adding this requirement to the code provides additional safety for systems that supply drinking water

602.3.5 Pumps. Pumps shall be rated for the transport of potable water. Pumps in an individual water supply system shall be constructed and installed so as to prevent contamination from entering a potable water supply through the pump units. **Pumps intended to supply drinking water shall conform to NSF 61.** Pumps shall be sealed to the well casing or covered with a water-tight seal. Pumps shall be designed to maintain a prime and installed such that ready access is provided to the pump parts of the entire assembly for repairs.

605.12.3 & 605.13.6 Solder Joints to Comply with NSF 61

Change Type: Modification

605.12.3 Solder joints.

Solder joints shall be made in accordance with ASTM B828. Cut tube ends shall be reamed to the full inside diameter of the tube end. Joint surfaces shall be cleaned. A flux conforming to ASTM B813 shall be applied. The joint shall be soldered with a solder conforming to ASTM B32. The joining of water supply piping shall be made with lead-free solder and fluxes. "Lead free" shall mean a chemical composition equal to or less than 0.2-percent lead. **Solder and flux joining pipe or fittings intended to supply drinking water shall conform to NSF 61.**

605.15.2 and 605.14.2 Solvent cementing (of CPVC joints)

Change Type: Virginia Amendment - Modification

- This VA amendment adds the option for solvent **green in color** for one-step solvent cementing of CPVC piping and joints when the other conditions for omitting primer are met
- One-step CPVC cement can now be **yellow OR green**, which stands out better on CPVC pipe and fittings, allowing for installers and inspectors to more easily identify any joints that were not cemented

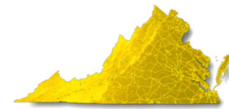

606.1 Individual Tenant Water Shut-off Valve

Change Type: Modification

- Multiple tenant buildings must have a main water shutoff valve for each tenant space

606.1 Location of full-open valves. Full-open valves shall be installed in the following locations:

1. On the building water service pipe from the public water supply near the curb.
2. On the water distribution supply pipe at the entrance into the structure.

2.1. In multiple-tenant buildings, where a common water supply piping system is installed to supply other than one- and two-family dwellings, a main shutoff valve shall be provided for each tenant.

(Items 3 through 8 remain unchanged)

607.1.1, 607.1.2 Water Heaters Providing Tempered Water to Fixtures

Change Type: Modification

- New designs of water heaters are available that provide reliable and accurate control of the temperature of the heated water and are now recognized by the code (standards ASSE 1082 and 1084)

607.1.2 Tempered water temperature control. Tempered water shall be ~~supplied through a water temperature controlled by one of the following:~~

1. ~~A limiting device that conforms~~ conforming to ASSE 1070/ASME A112.1070/CSA B125.70 ~~and shall limit the tempered water to not greater than~~ and set to a maximum of 110°F (43°C).
2. **A thermostatic mixing valve conforming to ASSE 1017.**
3. **A water heater conforming to ASSE 1082.**
4. **A water heater conforming to ASSE 1084.**

608.15.2.1 Discharge from Backflow Preventer Relief Opening

Change Type: Modification

- Where backflow preventers relieve indoors, the relief discharge must be directed to an adequately sized waste receptor

608.15.2.1 Relief port piping. The termination of the piping from the relief port or air gap fitting of a backflow preventer shall discharge to an approved indirect waste receptor or to the outdoors where it will not cause damage or create a nuisance. **The indirect waste receptor and drainage piping shall be sized to drain the maximum discharge flow rate from the relief port as published by the backflow preventer manufacturer.**



608.17.2 Backflow Device for Low Hazard Boiler Applications

Change Type: Modification

- The code adds a recognized standard, ASSE 1081, for a combination pressure regulator/backflow preventer product for boilers

608.17.2 Connections to boilers. The potable supply to the boiler shall be equipped with a backflow preventer with an intermediate atmospheric vent complying with ASSE 1012, **ASSE 1081**, or CSA B64.3. Where conditioning chemicals are introduced into the system, the potable water connection shall be protected by an air gap or a reduced pressure principle backflow preventer, complying with ASSE 1013, AWWA C511 or CSA B64.4.

609.2 Two Water Service Pipes for Hospitals Group I-2, Condition 2 Healthcare Facilities

Change Type: Modification

- Removing the term “hospitals” and replacing it with “**Group I-2, Condition 2 facilities**” (as detailed in Chapter 3 of the IBC/VCC) provides clarity as to which buildings require the redundancy based on the building’s occupancy classification
- This modification also adds requirements for shutoff valves on those water lines and recognizes that not all such facilities will be served by a water utility (some could have ground water wells or other means)

609.2 Water service for Group 1-2, Condition 2 facilities. ~~Hospitals~~ **Group 1-2, Condition 2 facilities** shall have not fewer than two water service pipes installed in such a manner so as to minimize the potential for an interruption of the supply of water in the event of a water main or water service pipe failure, **sized such that with the loss of the largest service pipe, the remaining service pipes will meet the water demand for the entire facility.** **Each water service shall have a shutoff valve in the building and a shutoff valve at the utility-provided point of connection to the water main or other source of potable water.**

VCC/IBC 308.3 Institutional Group I-2...shall include buildings and structures used for medical care **on a 24-hour basis for more than five persons who are incapable of self-preservation.**

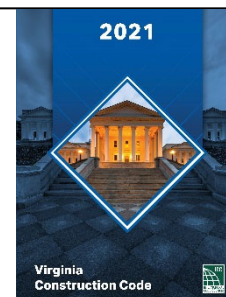

308.3.1.2 Condition 2... shall include facilities **that provide nursing and *medical care*** and could provide emergency care, surgery, obstetrics or in-patient stabilization units for psychiatric or detoxification, **including but not limited to *hospitals*.**

609.2.1 Tracer Wire for Buried Nonmetallic Water Service Piping serving Hospitals

Change Type: Modification

- Tracer wire is **already required in VA per amendments to 603.3** (since 2015 code cycle) **on all underground nonmetallic water service piping connecting to public systems.** (and 703.7 for sanitary drainage)
- Virginia 603.3 would continue to apply to all buried nonmetallic water service piping connecting to public systems
- This new requirement **would apply** to Hospitals connected to a **private water supply** (VPC Section 603.3 only applies to water service piping that connects to public systems)



Table 702.3 ABS Building Sewer Pipe Standard

Change Type: Addition

- Another form of ABS pipe (ABS composite wall ASTM D2680) is added to the table of building sewer pipe standards. The standard covers nominal pipe sizes of 8, 10, 12, and 15 inches
- This form of pipe is a composite wall construction where concentric inner and outer walls are braced by an integral truss-type structure. The resultant annular space between the walls is filled with a Portland cement/pearlite mixture
- The product has a pipe stiffness of at least 200 psi to provide for very low deflection values for deep burial conditions as well as for AASHTO live loading conditions at less than one foot of cover



PVC and ABS Push-fit DWV Fittings

Change Type: Addition

- Section 705.2.4 (ABS)
- Section 705.10.4 (PVC)



705.2.4 Push-fit joints. Push-fit DWV fittings shall be listed and labeled to ASME A112.4.4 and shall be installed in accordance with the manufacturer's instructions.

705.10.4 Push-fit joints. Push-fit joints shall conform to ASME A112.4.4 and shall be installed in accordance with the manufacturer's instructions.

708.1.6 Cleanout equivalent

Change Type: Addition

- Removable traps and removeable fixtures with integral traps are acceptable as equivalent to cleanouts



708.1.6 Cleanout equivalent. A fixture trap or a fixture with integral trap, removable without altering concealed piping, shall be acceptable as a cleanout equivalent.

903.1.3 Protected Outdoor Vent Termination Method

Change Type: Addition

- New requirements for protected outdoor roof vent terminals accommodate solar panel and architectural roof feature installations



Architectural shroud

903.1.3 Protected vent terminal. Where an open vent pipe terminates above a sloped roof and is covered by either a roof-mounted panel (such as a solar collector or photovoltaic panel mounted over the vent opening) or a roof element (such as an architectural feature or a decorative shroud), the vent pipe shall terminate not less than 2 inches (51 mm) above the roof surface. Such roof elements shall be designed to prevent the adverse effects of snow accumulation and wind on the function of the vent. The placement of a panel over a vent pipe and the design of a roof element covering the vent pipe shall provide for an open area for the vent pipe to the outdoors that is not less than the area of the pipe, as calculated from the inside diameter of the pipe. Such vent terminals shall be protected by a method that prevents birds and rodents from entering or blocking the vent pipe opening.

915.1 Food Waste Disposers on Combination Waste and Vent Systems

Change Type: Modification

- Food waste disposers can now discharge to a combo waste & vent system
- Laboratory investigations and years of recent field experience have proven that the prohibition on combination waste and vent systems receiving the discharge of food waste disposers is unwarranted

915.1 Type of fixtures. A combination waste and vent system shall not serve fixtures other than floor drains, sinks, lavatories and drinking fountains. Combination waste and vent systems shall not receive the discharge from a ~~food waste disposer or~~ clinical sink.

1002.1 Direct Connection to Hydromechanical Grease Interceptor

Change Type: Modification

- Existing exception #3 allowing grease interceptors to serve as fixture traps has been modified with more specific requirements and renumbered as exception #4
- A one, two or three-compartment pots and pans sink without a trap can be directly connected to a hydromechanical grease interceptor provided that the grease interceptor is in close proximity and connects to a drainage branch that has an emergency floor drain connected immediately downstream of the interceptor



1002.1 Fixture traps. Each plumbing fixture shall be separately trapped by a liquid-seal trap, except as otherwise permitted by this code... *(section shortened)*

Exceptions

1. and 2. (remain unchanged)

~~3. A grease interceptor intended to serve as a fixture trap in accordance with the manufacturer's installation instructions shall be permitted to serve as the trap for a single fixture or a combination sink of not more than three compartments where the vertical distance from the fixture outlet to the inlet of the interceptor does not exceed 30 inches (762 mm) and the developed length of the waste pipe from the most upstream fixture outlet to the inlet of the interceptor does not exceed 60 inches (1524 mm).~~

3. Floor drains in multilevel parking structures that discharge to a building storm sewer shall not be required to be individually trapped. Where floor drains in multilevel parking structures are required to discharge to a combined building sewer system, the floor drains shall not be required to be individually trapped provided that they are connected to a main trap in accordance with Section 1103.1.

4. Where a hydromechanical grease interceptor serves a food utensil, dishes, pots-and-pans sink, in accordance with the manufacturer's installation instructions. The branch drain serving the interceptor shall be provided with an emergency floor drain downstream of the interceptor connection, and the branch shall serve only the emergency floor drain and the interceptor. Where the interceptor serves a combination sink of not more than three compartments where the vertical distance from the fixture outlet to the inlet of the interceptor does not exceed 30 inches (762 mm) and the developed length of the waste pipe from the most upstream fixture outlet to the inlet of the interceptor does not exceed 60 inches (1524 mm). The food utensil, dishes, pots and pans sink shall be required to connect directly with the interceptor.

1002.4.1.5 Fixture Drains Serving as a Trap Priming Method

Change Type: Addition

- A lavatory, hand sink or drinking fountain fixture drain can serve as a method for protecting a floor drain, trench drain or floor sink trap seal
- This method is an extension of the concept in Section 1002.4.1.3 where a portion of the waste flow from a lavatory is directed to another fixture requiring its trap seal to be protected from evaporation. This method allows the entire flow to be directed to such traps



1002.4.1.5 Fixture drain connection for trap priming. A fixture drain from a lavatory or hand sink shall serve as a method of providing trap seal protection for an emergency floor drain, a trench drain, or a floor sink where such fixtures are located in the same room. A fixture drain from a drinking fountain shall serve as a method of providing trap seal protection for an emergency floor drain, a trench drain, or a floor sink where such fixtures are in the same room or in a room adjacent to the room having the drinking fountain. The fixture drain shall not be routed on or above the surface of the floor and shall connect to the floor drain, trench drain, or floor sink at a point that is below the flood level rim and above the inlet to the trap of the receiving fixture.

1003.3.2 Food waste disposers

Change Type: Virginia Amendment - Modification

- Reverts to the 2015 VPC requirements allowing food waste disposers to discharge to grease interceptors when certain conditions are met

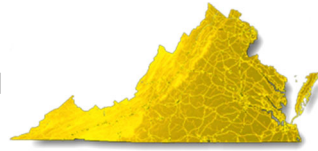

1003.3.2 Food waste disposers. Where food waste disposers connect to grease interceptors, a solids interceptor shall separate the discharge before connecting to the grease interceptor. Solids interceptors and grease interceptors shall be sized and rated for the discharge of the food waste disposers. Emulsifiers, chemicals, enzymes, and bacteria shall not discharge into the food waste disposer.

1202.1 Nonflammable Medical Gases

Change Type: Modification

- Language is added to clarify systems are to be installed, tested and labeled per NFPA 99

1202.1 Nonflammable medical gases. Nonflammable medical gas systems, inhalation anesthetic systems and vacuum piping systems shall be ~~designed~~ **installed, tested** and ~~installed~~ **labeled** in accordance with NFPA 99.



2021 Virginia Mechanical Code

307.1.1, 307.2.3.3 Identification

Change Type: Addition

- Two NEW sections have been added, requiring primary and secondary condensate drain lines to be marked at their termination.

(Fuel-burning appliances) 307.1.1 Identification. The termination of concealed condensate piping shall be marked to indicate whether the piping is connected to the primary or to the secondary drain.

(Evaporators and Cooling coils) 307.2.3.3 Identification. The termination of concealed condensate piping shall be marked to indicate whether the piping is connected to the primary or to the secondary drain.

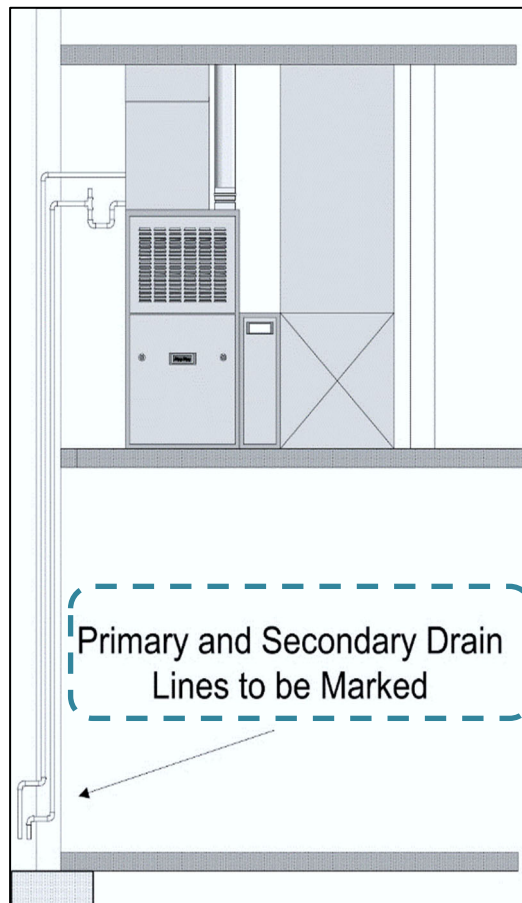

307.2.1.1 Condensate Discharge

Change Type: Addition

- New requirements have been added for the condensate point of discharge.

307.2.1.1 Condensate discharge. Condensate drains shall not directly connect to any plumbing drain, waste or vent pipe. Condensate drains shall not discharge into a plumbing fixture other than a floor sink, floor drain, trench drain, mop sink, hub drain, standpipe, utility sink or laundry sink. Condensate drain connections to a lavatory wye branch tailpiece or to a bathtub overflow pipe shall not be considered as discharging to a plumbing fixture. Except where discharging to grade outdoors, the point of discharge of condensate drains shall be located within the same occupancy, tenant space or dwelling unit as the source of the condensate.

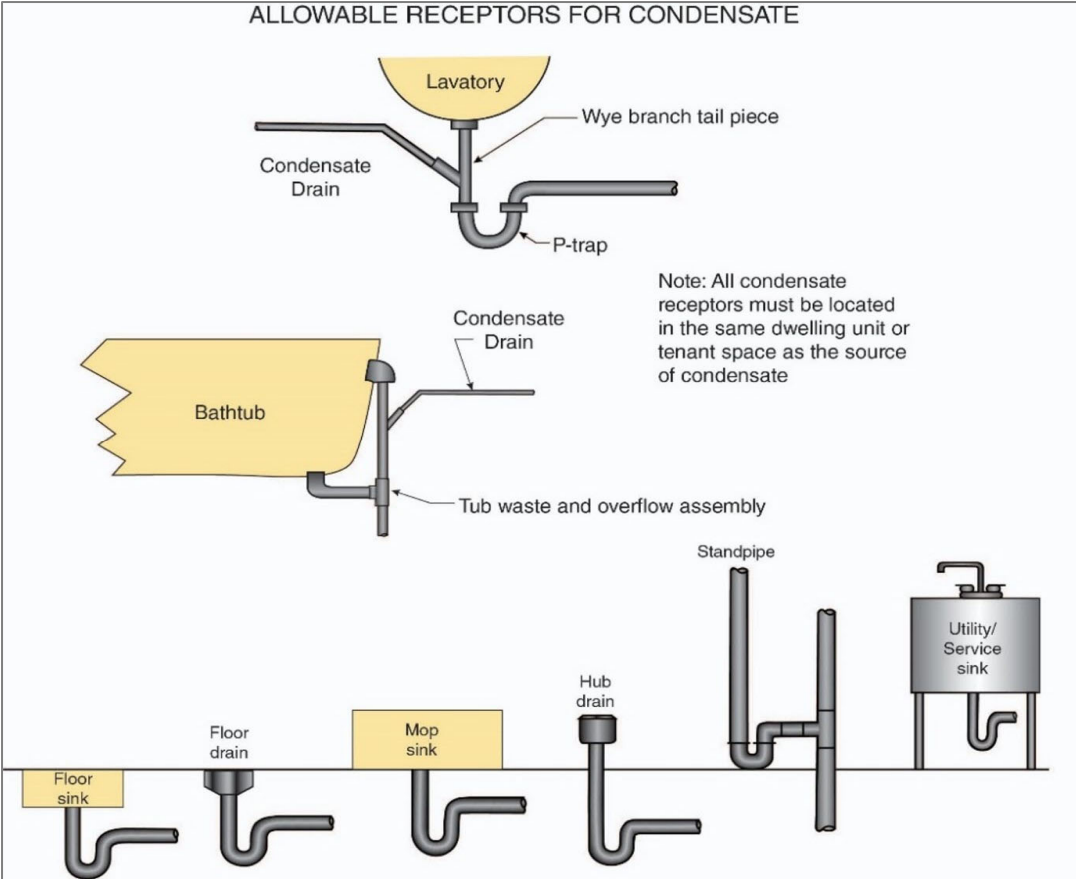

401.4, 501.3.1 Intake Opening and Exhaust Outlet Locations

Change Type: Modification

- A new type of factory-built combination exhaust and intake air fitting is introduced that does not require separation between the two openings.



401.4 Intake Opening Location Item #3. Intake openings shall be located not less than 3 feet (914 mm) below contaminant sources where such sources are located within 10 feet (3048 mm) of the opening. **Separation is not required between intake air openings and living space exhaust air openings of an individual dwelling unit or sleeping unit where an approved factory-built intake/exhaust combination termination fitting is used to separate the air streams in accordance with the manufacturer's instructions.**

501.3.1 Location of exhaust outlets. Intake Opening and Location Item #3. For all environmental air exhaust: 3 feet (914 mm) from property lines; 3 feet (914 mm) from operable openings into buildings for all occupancies other than Group U; and 10 feet (3048 mm) from mechanical air intakes. Such exhaust shall not be considered hazardous or noxious. **Separation is not required between intake air openings and living space exhaust air openings of an individual dwelling unit or sleeping unit where an approved factory-built intake/exhaust combination termination fitting is used to separate the air streams in accordance with the manufacturer's instructions.**

403.2.1.2 Recirculation of Air to Swimming Pool and Associated Deck Areas

Change Type: Modification

- Supply air to a swimming pool and associated deck areas shall not be recirculated unless such air is dehumidified to maintain the relative humidity of the area at 60 percent or less.
- This section has been modified to require that the design and installation of dehumidification systems shall comply with ANSI/ACCA 10 Manual SPS.
- ACCA Manual SPS, *HVAC Design for Swimming Pools and Spas*, is a manual specifically for the design of HVAC systems for indoor pools and spas.

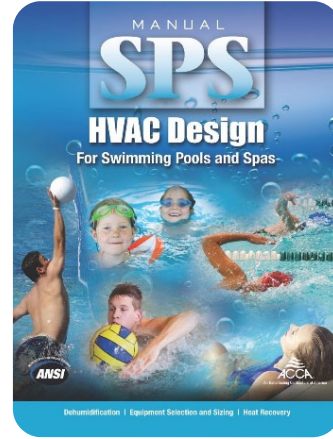

Table 403.3.1.1 Minimum Ventilation Rates

Change Type: Modification

- Table 403.3.1.1, the minimum ventilation rates for Commercial Laundries, Kitchens, and Toilet rooms and bathrooms, have been updated as shown.
- These changes match the minimum ventilation rates found in ASHRAE Standard 62.1, which is the source for the values found in this table.

Occupancy Classification	Occupant Density #/1000 Ft ^{2a}	People Outdoor Airflow Rate in Breathing Zone, R _p CFM/Person	Area Outdoor Airflow Rate in Breathing Zone, R _a CFM/Ft ^{2a}	Exhaust Airflow Rate CFM/Ft ^{2a}
Commercial Laundry	10	25 5	0.12	-
Kitchens ^b	-	-	-	25 50/100f
Toilet rooms and bathrooms	-	-	-	20 25/50f

Ventilation Rates for all other Occupancy Classifications in table remain unchanged

Table 403.3.1.1 Minimum Ventilation Rates

Change Type: Clarification



- This clarification updates footnote i (an existing VA amendment) to include “spaces that are located in clinic, outpatient facilities as defined in Chapter 2 of the VCC”.
- In addition, footnote i is added to “medical procedure rooms”
- *Only the “Medical Facilities” section of the table is shown*
- VA Proposal M403.3.1.1-21

Occupancy Classification	Occupant Density #/1000 Ft ^{2a}	People Outdoor Airflow Rate in Breathing Zone, R _p CFM/Person	Area Outdoor Airflow Rate in Breathing Zone, R _a CFM/Ft ^{2a}	Exhaust Airflow Rate CFM/Ft ^{2a}
Medical Facilities				
Medical procedure rooms ⁱ	20	15	-	-
Patient rooms ⁱ	10	25	-	-
Physical therapy rooms ⁱ	20	15	-	-

i. For spaces that are ~~not~~ located in an ambulatory care facility or clinic, outpatient facilities as defined in Chapter 2 of the VCC.

Table 403.3.1.1 Note g Recirculation of Air

Change Type: Modification

- The revised text clarifies the original intent, which was to allow only a small amount of air to leak from the exhaust airstream of a wheel type ERV into the outdoor airstream of that ERV. The intent of this section is now consistent with ASHRAE 62.1, which is the basis for Table 403.3.1.1.

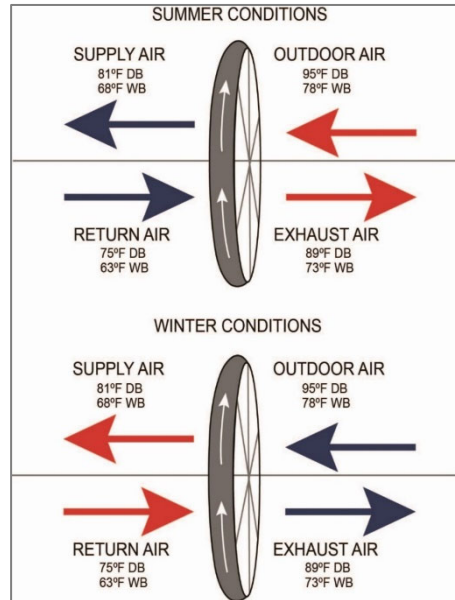

Note g: Mechanical exhaust is required and recirculation from such spaces is prohibited. **For occupancies other than science laboratories, where there is a wheel-type energy recovery ventilation (ERV) unit in the exhaust system design, the volume of air leaked from the exhaust airstream into the outdoor airstream within the ERV shall be less than 10 percent of the outdoor air volume.** Recirculation of air that is contained completely within such spaces shall not be prohibited (see Section 403.2.1, Items 2 and 4).

403.3.1.3 Demand Controlled Ventilation

Change Type: Modification

- This change clarifies that demand control ventilation schemes cannot eliminate all ventilation in a space while that space is expected to be occupied.

403.3.1.3 System operation. The minimum flow rate of outdoor air that the ventilation system must be capable of supplying during its operation shall be permitted to be based on the rate per person indicated in Table 403.3.1.1 and the actual number of occupants present. **Where demand-controlled ventilation is employed to adjust the outdoor airflow rate based on the actual number of occupants present, the minimum quantity of outdoor air shall not fall below that determined from the area outdoor airflow rate column of Table 403.3.1.1 during periods when the building is expected to be occupied.**

403.3.2.1 Outdoor Air for Dwelling Units

Change Type: Modification

- **New Exception (#2)** allows for a 30% reduction in the minimum mechanical ventilation rate when the conditions are met.

2. The minimum mechanical ventilation rate determined in accordance with Equation 4-9 shall be reduced by 30% provided that **both** of the following conditions apply:

2.1. A ducted system supplies ventilation air **directly to each bedroom and to one** of the following rooms:

2.1.1. Living Room

2.1.2. Dining Room

2.1.3. Kitchen

2.2. **The whole-house ventilation system is a *balanced ventilation system*.**

BALANCED VENTILATION. Any combination of concurrently operating mechanical exhaust and mechanical supply whereby the total mechanical exhaust airflow rate is within 10 percent of the total mechanical supply airflow rate.

Example calculation of ventilation rate and 30% reduction credit

Example: 1500 sq. foot, 3 bedroom home

$$Q = 0.01A_{\text{floor}} = 705(N_{br} + 1).$$

$$\text{Outdoor air cfm} = (0.01 \times 1500) = [7.5 \times (3 + 1)]$$

$$\text{O.A. cfm} = 15 + 30 = 45$$

Balanced ventilation system means:

45 cfm O.A. supply with 45 cfm exhaust or

45 cfm O.A. supply with 40.5 to 49.5 cfm exhaust

(see definitions of "balanced ventilation")

New exception 2 allows a 30% reduction for systems:

1. That are balanced and
2. That supply outdoor air through ducts to each bedroom and at least one of the following rooms: living room, dining room, kitchen

Balanced ventilation system O.A. cfm = 45

$$45 \times 0.3 = 13.5 \text{ cfm}$$

$$45 - 13.5 = 31.5 \text{ cfm}$$

Or

$$45 \times 0.7 = 31.5 \text{ cfm}$$

502.20 Manicure and Pedicure Station Exhaust System

Change Type: Modification

- Required exhaust systems in nail salons are often not operated as intended, for reasons including fan noise, saving energy, and neglecting to turn on the system.
- This new code section will require the exhaust system to operate continuously while the space is occupied, which presumably means during the hours that the salon is open for business.



502.20.1 Operation. The exhaust system for manicure and pedicure stations shall have controls that operate the system continuously when the space is occupied.

504.4.1 Termination Location for Dryer Exhaust

Change Type: Modification

- Previously, the code did not address the required separation between building openings and clothes dryer exhaust terminations.
- This new section defers to the appliance installation instructions, and if the instructions are silent on the matter, a 3-foot minimum separation distance is specified.

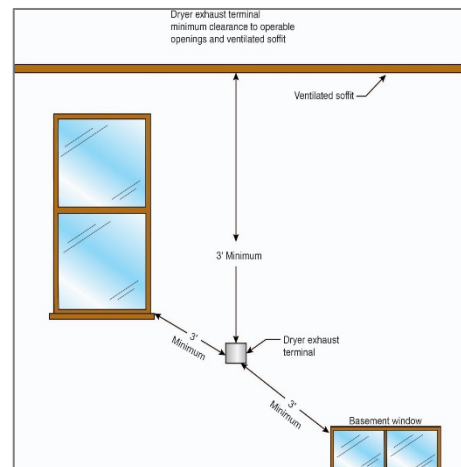

504.4.1 Termination location. Exhaust duct terminations shall be in accordance with the dryer manufacturer's installation instructions. Where the manufacturer's instructions do not specify a termination location, the exhaust duct shall terminate not less than 3 feet (914 mm) in any direction from openings into buildings including openings in ventilated soffits.

504.6 Booster fans prohibited

Change Type: Clarification

- Booster fans were a class of ventilators that were installed before the introduction of dryer exhaust duct power ventilators or DEDPVs.
- DEDPVs are regulated by UL 705, whereas old style booster fans were not specifically addressed in any UL standard.
- DEDPVs are not impacted since VMC 504.5 and VRC M1502.4.4 permit the installation and use of DEDPVs.

504.6 Booster fans prohibited. Domestic booster fans shall not be installed in dryer exhaust systems.

506.3.7 Factory-Built Grease Duct Slope

Change Type: Modification

- This new exception exempts factory-built grease ducts from the duct slope prescriptions of the code, relying instead on the slope requirements stated in the product listing and manufacturer's installation instructions.

506.3.7 Prevention of grease accumulation in grease ducts. Duct systems serving a Type I hood shall be constructed and installed so that grease cannot collect in any portion thereof, and the system shall slope not less than one-fourth unit vertical in 12 units horizontal (2-percent slope) toward the hood or toward a grease reservoir designed and installed in accordance with Section 506.3.7.1. Where horizontal ducts exceed 75 feet (22 860 mm) in length, the slope shall be not less than one unit vertical in 12 units horizontal (8.3-percent slope).

Exception: Factory-built grease ducts shall be installed at a slope that is in accordance with the listing and manufacturer's installation instructions.

506.3.9 Grease duct horizontal cleanouts

Change Type: Modification

- NEW language has been added in Section 506.3.9 Item #7 requiring that cleanouts be provided **within 3 feet of horizontal discharge fans.**
- This change will make it much more likely that kitchen hood exhaust fans will be maintained and serviced regularly.

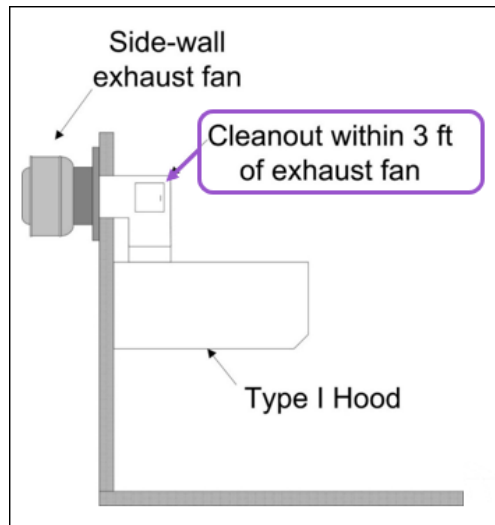

507.1 Smoker Ovens with Integral Exhaust

Change Type: Modification

- New exception exempts smoker ovens from the requirement for a Type I hood where such ovens have an **integral exhaust system** and are **listed for installation without a Type I hood.**

507.1 New Exception #4: Smoker ovens with integral exhaust systems, provided that the appliance is installed in accordance with the manufacturer's installation instructions, is listed and tested for the application, and complies with Chapter 5.



514.2 Energy Recovery Ventilation (ERV) Systems

Change Type: Modification

- The reference to Type II hoods in item 4 was deleted which means that heat from the exhaust from Type II hoods can now be recovered by any appropriate type of ERV.
- The exhaust from Type II hoods consists of waste heat and water vapor and is not expected to be harmful to ERV equipment.

514.2 Prohibited applications. Energy recovery ventilation systems shall not be used in the following systems:

(items 1-3 unchanged)

4. Commercial kitchen exhaust systems serving Type I ~~or Type II~~ hoods.

(item 5 unchanged)

602.2.1.8 Pipe and Duct Insulation Within Plenums

Change Type: Modification

- This revision addresses the practice of using pipe insulation materials to protect piping that does not meet the required fire performance requirements.

602.2.1.8 Pipe and duct insulation within plenums. Pipe and duct insulation contained within plenums, including insulation adhesives, shall have a flame spread index of not more than 25 and a smoke developed index of not more than 50 when tested in accordance with ASTM E84 or UL 723, using the specimen preparation and mounting procedures of ASTM E2231. Pipe and duct insulation shall not flame, glow, smolder or smoke when tested in accordance with ASTM C411 at the temperature to which they are exposed in service. The test temperature shall not fall below 250°F (121°C). Pipe and duct insulation shall be listed and labeled. **Pipe and duct insulation shall not be used to reduce the maximum flame spread and smoke-developed indices except where the pipe or duct and its related insulation, coatings and adhesives are tested as a composite assembly in accordance with Section 602.2.1.7.**

607.5.2 Duct Penetrations of Fire Barriers

Change Type: Modification

- New item 3.2 of Exception 3 sets three conditions that must be met for the allowance of *flexible air connectors* in a fully ducted HVAC system:
 1. The *flexible air connectors* are subject to Sections 603.6.2 through 603.6.2.2 which require listing and labeling to UL 181; limit the length to 14 feet and prohibit the connectors from passing through any wall, floor or ceiling.
 2. The *flexible air connectors* are installed only above the ceiling to connect metal ducts to ceiling diffusers.
 3. The metal duct, the ceiling diffuser and the *flexible air connector* are all located in the same room.

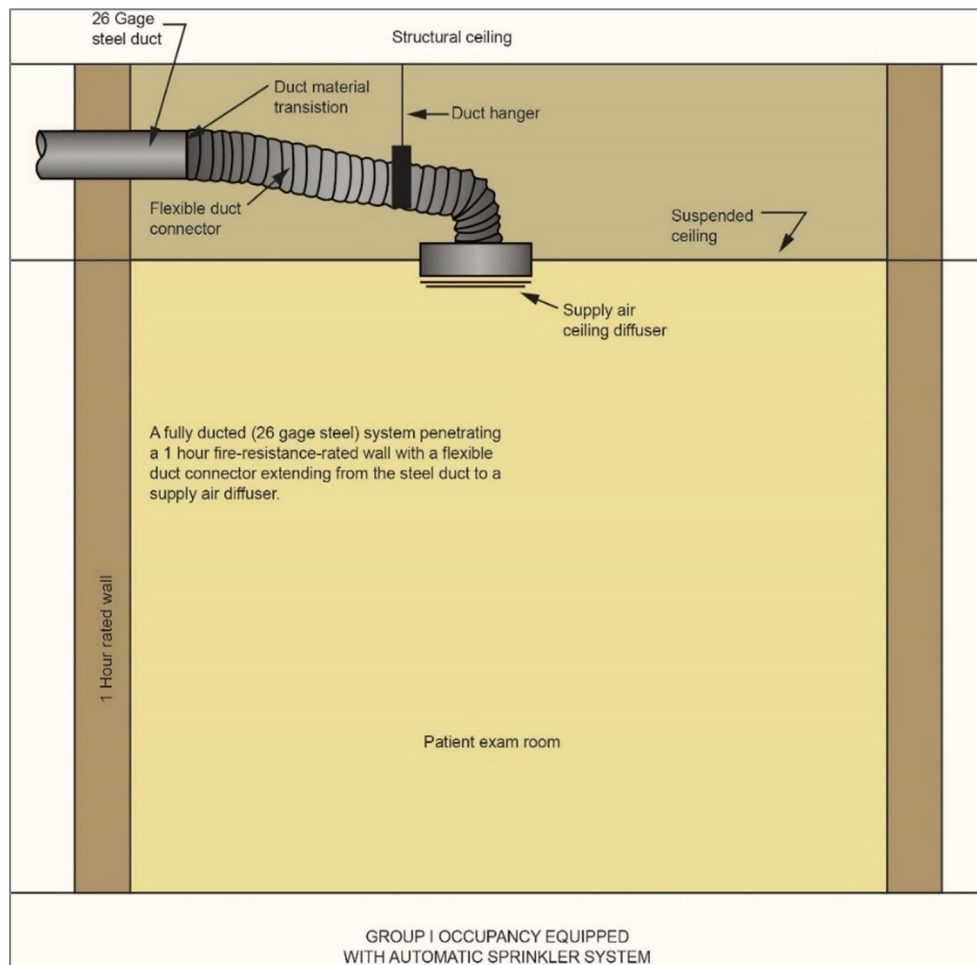

403.3.1.5 608.1 Balancing

Change Type: Modification

- The movement of this requirement from Chapter 4 (Ventilation) to Chapter 6 (Ducts) will require that **all air conveyance systems be provided with a balancing means** as opposed to only ventilation air systems.



608.1 Balancing. Air distribution, ventilation and exhaust systems shall be provided with means to adjust the system to achieve the design airflow rates and shall be balanced by an approved method. Ventilation air distribution shall be balanced by an approved method and such balancing shall verify that the air distribution system is capable of supplying and exhausting the airflow rates required by Chapter 4.

801.21 Blocked Vent Switch for Oil-Fired Appliances

Change Type: Clarification

- A requirement was added for an additional safety device for oil-fired appliances.

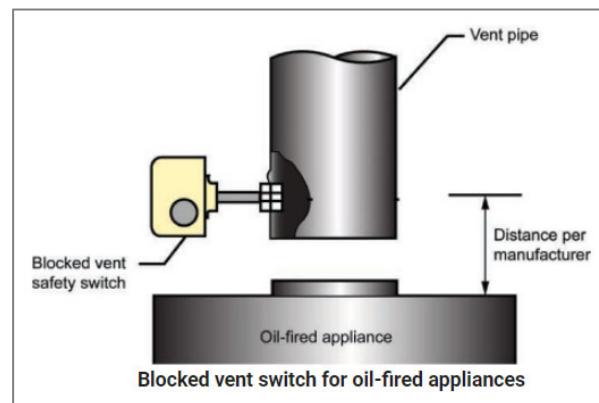

801.21 Blocked vent switch. Oil-fired appliances shall be equipped with a device that will stop burner operation in the event that the venting system is obstructed. Such device shall have a manual reset and shall be installed in accordance with the manufacturer's instructions.

905.1 New Wood-Burning Residential Hydronic Heaters

Change Type: Modification

- The revision makes the code consistent with EPA rules for heater emissions.

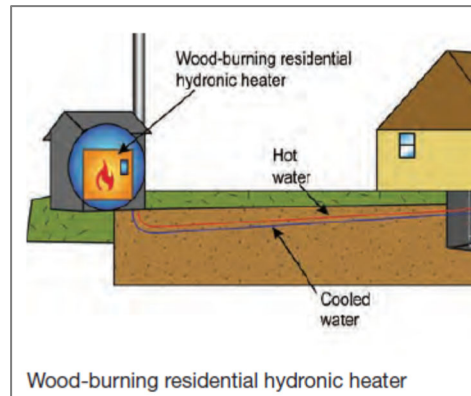

905.1 General. Fireplace stoves and solid-fuel-type room heaters shall be listed and labeled and shall be installed in accordance with the conditions of the listing. Fireplace stoves shall be tested in accordance with UL 737. Solid-fuel-type room heaters shall be tested in accordance with UL 1482. Fireplace inserts intended for installation in fireplaces shall be listed and labeled in accordance with the requirements of UL 1482 and shall be installed in accordance with the manufacturer's instructions. **New wood-burning residential hydronic heaters shall be EPA certified.**

Section 920 Unit Heaters

Change Type: Addition

- New code language added to Section 920 limits the use of suspended type unit heaters in Group I-2 and ambulatory care facilities.

920.4 Prohibited Uses. In Group I-2 and ambulatory care facilities, suspended-type unit heaters are prohibited in corridors, exit access stairways and ramps, exit stairways and ramps, and patient sleeping areas.

929 Unvented Alcohol Fuel Burning Decorative Appliances

Change Type: Addition

- Coverage was added for a new type of decorative fuel-burning appliance, about which the code was previously silent.
- Includes new requirements at 929.1 and a new definition.



929.1 GENERAL. *Unvented alcohol fuel-burning decorative appliances shall be listed and labeled in accordance with UL1370 and shall be installed in accordance with the conditions of the listing, manufacturer's installation instructions, and Chapter 3.*

202 Definitions - Unvented Alcohol Fuel Burning Decorative Appliance

A stationary, self-contained appliance intended to be directly or indirectly secured to a wall or floor and not intended for duct connection. Such appliance burns alcohol and is made in a manufacturing facility for subsequent delivery to the installation site.

Chapter 11 – Major Refrigeration / Refrigerant Updates

Change Type: New/Modification

- Multiple coordinated proposals were submitted this cycle to bring in already approved refrigerant /refrigeration requirements and standards from the 2024 IMC.
- In addition, specific requirements for ammonia refrigeration have been removed from this chapter and replaced with references to the suite of International Institute of Ammonia Refrigeration (IIAR) standards already referenced in the VMC/IMC.

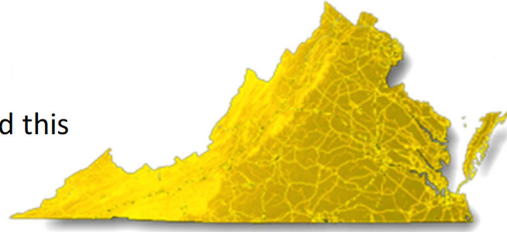

1101 General – Table 1101.2

Change Type: Addition

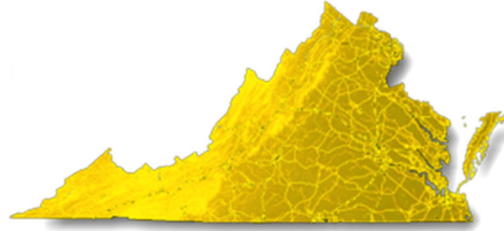

- Table 1101.2 was added to identify the standards that apply to the various types of refrigeration equipment and appliances to assist in uniform application of this code requirement.
- This VA amendment (M1101.2(2) adopts 2024 IMC table 1101.2

(2021 VRC/2024 IMC) Table 1101.2 Factory-built equipment and appliances	
<u>EQUIPMENT</u>	<u>STANDARDS</u>
<u>Air-conditioning equipment and heat pump</u>	<u>UL 1995 or UL/CSA 60335-2-40</u>
<u>Packaged terminal air conditioners and heat</u>	<u>UL 484 or UL/CSA 60335-2-40</u>
<u>Split-system air conditioners and heat pumps</u>	<u>UL 1995 or UL/CSA 60335-2-40</u>
<u>Dehumidifiers</u>	<u>UL 474 or UL/CSA 60335-2-40</u>
<u>Air/water cooled condensers</u>	<u>UL 1995 or UL/CSA 60335-2-40 or UL/CSA 60335-</u>
<u>Refrigeration <i>equipment</i></u>	<u>UL 1995 or UL/CSA 60335-2-89</u>
<u>Unit coolers</u>	<u>UL 412 or UL/CSA 60335-2-89</u>
<u>Commercial refrigerators, freezers, beverage coolers and walk-in coolers</u>	<u>UL 471 or UL/CSA 60335-2-89</u>
<u>Refrigerating units and walk-in coolers</u>	<u>UL 427 or UL 60335-2-89</u>
<u>Refrigeration condensing units</u>	<u>UL 1995 or UL/CSA 60335-2-89</u>
<u>Automatic commercial ice machines</u>	<u>UL 563 or UL/CSA 60335-2-89</u>
<u>Refrigerant-containing components and accessories</u>	<u>UL 207</u>

Table 1103.1 – Refrigerant Classification, Amount, and Occupational Exposure Limit (OEL)

Change Type: Modification

- Table is updated to align with 2024 ICC requirements and adds additional refrigerant types and changes the classification, amount, and OEL for many refrigerant types.
- See Code for full table (table now includes 187 specific refrigerant types)
- VA Proposal M1103.1 - 21

1105.9 Machinery Room Means of Egress

Change Type: Addition

- Revised egress requirements for machinery rooms from the IBC/VCC were added to the IMC/VMC to prevent such requirements from being overlooked.

1105.9 Means of egress. Machinery rooms larger than 1000 square feet (93 m^2) in area shall have not less than two exits or exit access doorways. Where two exit access doorways are required, one such doorway is permitted to be served by a fixed ladder or an alternating tread device. Exit access doorways shall be separated by a horizontal distance equal to or greater than one-half of the largest horizontal dimension of the room. All portions of machinery rooms shall be within 150 feet (45.7 m) of an exit or exit access doorway. An increase in exit travel distance is permitted where in accordance with Section 1017.1 of the *International Building Code*. Exit and exit access doorways shall swing in the direction of egress travel and shall be equipped with panic hardware, regardless of the occupant load served. Exit and exit access doorways shall be tight-fitting and self-closing.

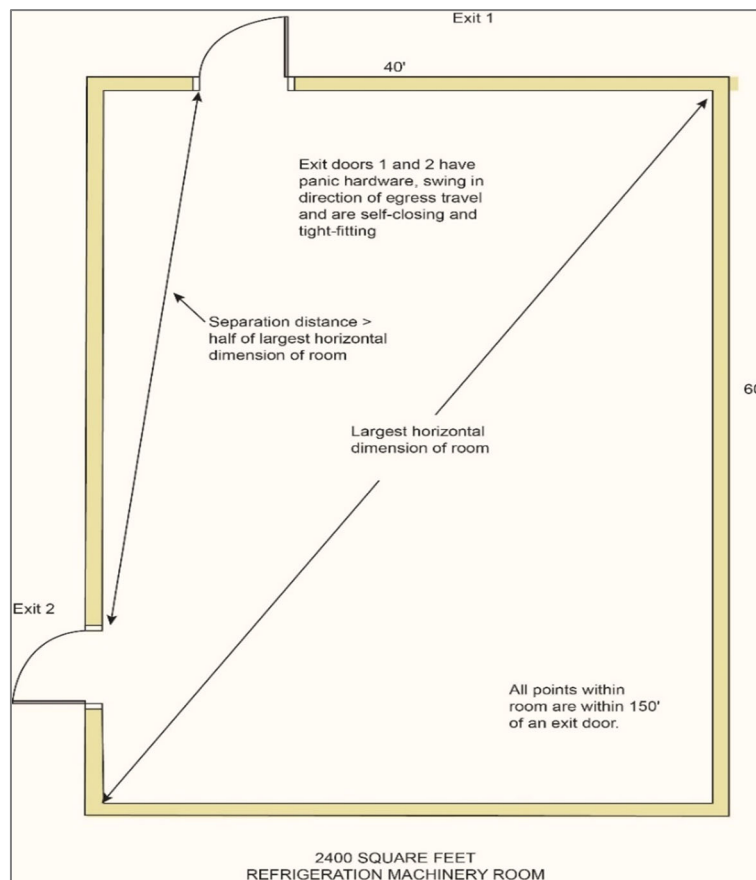

Sections 1107 through 1110

Change Type: Addition

- The rewrite of Section 1107 reorganizes existing text and updates provisions that have not been changed in many years.
- The new Sections 1107 through 1110 are the culmination of efforts by several experts in the field of refrigerant piping design and installation, and these new sections address piping for all refrigerants except ammonia.

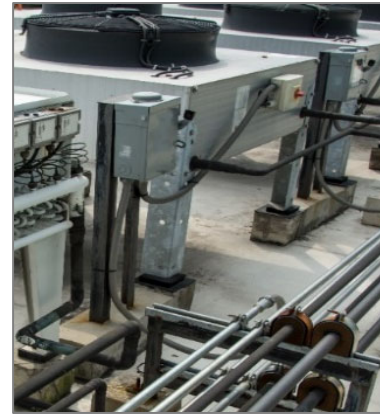

[Due to space constraints, only portions of Sections 1107 through 1110 are shown. Please refer to the 2021 VMC/IMC for the complete text and associated tables.]

SECTION 1107 PIPING MATERIAL

1107.1 Piping. Refrigerant piping material for other than R-717 (ammonia) systems shall conform to the requirements in this section. Piping material and installations for R-717 (ammonia) refrigeration systems shall comply with IIAR 2.

1107.2 Used materials. Used pipe, fittings, valves and other materials that are to be reused shall be clean and free of foreign materials and shall be approved for reuse.

1107.3 Material rating. Materials, joints and connections shall be rated for the operating temperature and pressure of the refrigerant system. Materials shall be suitable for the type of refrigerant and type of lubricant in the refrigerant system. Magnesium alloys shall not be used in contact with any halogenated refrigerants. Aluminum, zinc, magnesium and their alloys shall not be used in contact with R-40 (methyl chloride).

TABLE 1107.4 Refrigerant Pipe (see VMC/IMC)

TABLE 1107.5 Refrigerant Pipe Fittings (see VMC/IMC)

TABLE 1107.5.1 Copper Brazed Swaged Cup Depths (see VMC/IMC)

SECTION 1108
JOINTS AND CONNECTIONS

1108.1 Approval. Joints and connections shall be of an approved type, joints and connections shall be tight for the pressure of the refrigerant system when tested in accordance with Section 1110.

1108.1.1 Joints between different piping materials. Joints between different piping materials shall be made with approved adapter fittings. Joints between dissimilar metallic piping materials shall be made with a dielectric fitting or a dielectric union conforming to dielectric tests of ASSE 1079. Adapter fittings with threaded ends between different materials shall be joined with thread lubricant in accordance with Section 1108.3.4.

1108.2 Preparation of pipe ends. Pipe shall be cut square, reamed and chamfered, and shall be free of burrs and obstructions. Pipe ends shall have full-bore openings and shall not be undercut.

1108.3 Joint preparation and installation. Where required by Sections 1108.4 through 1108.9, the preparation and installation of brazed, flared, mechanical, press-connect, soldered, threaded and welded joints shall comply with Sections 1108.3.1 through 1108.3.5.

SECTION 1109

REFRIGERANT PIPE INSTALLATION

1109.1 General. Refrigerant piping installations, other than R-717 (ammonia) refrigeration systems, shall comply with the requirements of this section. The design of refrigerant piping shall be in accordance with ASMEB31.5.

1109.2 Piping location. Refrigerant piping shall comply with the installation location requirements of Sections 1109.2.1 through 1109.2.7. Refrigerant piping for Groups A2L and B2L shall also comply with the requirements of Section 1109.3. Refrigerant piping for group A2, A3, B2 and B3 shall also comply with the requirements of Section 1109.4.

1109.2.1 Minimum height. Exposed refrigerant piping installed in open spaces that afford passage shall be not less than 7 feet 3 inches (2210 mm) above the finished floor.

1109.2.2 Refrigerant pipe enclosure. Refrigerant piping shall be protected by locating it within the building elements or within protective enclosures.

Exception: Piping protection within the building elements or protective enclosure shall not be required in any of the following locations:

1. Where installed without ready access or located more than 7 feet 3 inches (2210 mm) above the finished floor.
2. Where located within 6 feet (1829 mm) of the refrigerant unit or appliance.
3. Where located in a machinery room complying with Section 1105.

1109.2.3 Prohibited locations. Refrigerant piping shall not be installed in any of the following locations:

1. Exposed within a fire-resistance-rated exit access corridor.
2. Within an interior exit stairway.
3. Within an interior exit ramp.
4. Within an exit passageway.
5. Within an elevator, dumbwaiter or other shaft containing a moving object.

TABLE 1109.3.2 Shaft Ventilation Velocity (see VMC/IMC)

SECTION 1110

REFRIGERANT PIPING SYSTEM TEST

1110.1 General. Refrigerant piping systems, other than R-717 (ammonia) refrigeration systems, that are erected in the field, shall be pressure tested for strength and leak tested for tightness, in accordance with the requirements of this section, after installation and before being placed in operation. Tests shall include both the high- and low-pressure sides of each system.

Exception: Listed and labeled equipment, including compressors, condensers, vessels, evaporators, gas bulk storage tanks, safety devices, pressure gauges and control mechanisms, shall not be required to be tested.

1110.2 Exposure of refrigerant piping system. Refrigerant pipe and joints installed in the field shall be exposed for visual inspection and testing prior to being covered or enclosed.

1110.3 Test gases. The medium used for pressure testing the refrigerant system shall be one of the following inert gases: oxygen-free nitrogen, helium or argon. For R-744 refrigerant systems, carbon dioxide shall be allowed as the test medium. For R-718 refrigerant systems, water shall be allowed as the test medium. Oxygen, air, combustible gases and mixtures containing such gases shall not be used as test medium. Systems erected on the premises with tubing not exceeding $\frac{5}{8}$ inch (15.9 mm) outside diameter shall be allowed to use the refrigerant identified on the nameplate label or marking as the test medium.

1110.4 Test apparatus. The means used to pressurize the refrigerant piping system shall have on its outlet side a test pressure measuring device and either a pressure-limiting device or a pressure-reducing device. The test pressure measuring device shall have an accuracy of ± 3 percent or less of the test pressure and shall have a resolution of 5 percent or less of the test pressure.

[Due to space constraints, only portions of Sections 1107 through 1110 are shown. Please refer to the 2021 IMC for the complete text and associated tables.]

Section 1203 Joints and Connections (CPVC in Hydronic Systems)

Change Type: Modification

- This change to Section 1203 recognizes a **mechanical joint as an acceptable joining option** for use with CPVC pipe.
- Mechanical joints with CPVC pipe have a proven track record in the field and are allowed by the IPC.

1203.7 CPVC plastic pipe. Joints between CPVC plastic pipe or fittings shall be **mechanical**, solvent-cemented or threaded joints conforming to Section 1203.3.

Section 1303 Joints and Connections (Fuel Oil Piping)

Change Type: Modification

- This change adds press-connect joints as an acceptable joining method for fuel oil piping.

1303.3 Joint preparation and installation. Where required by Sections 1303.4 through 1303.9, the preparation and installation of brazed, mechanical, threaded, [press-connect](#) and welded joints shall comply with Sections 1303.3.1 through ~~1303.3.4.~~1303.3.5.

1303.3.2 Mechanical joints. Mechanical joints shall be installed in accordance with the manufacturer's instructions. ~~Press-connect joints shall conform to one of the standards listed in Table 1302.3.~~

1303.3.5 Press-connect joints. [Press-connect joints shall be installed in accordance with the manufacturer's instructions and shall conform to one of the standards listed in Table 1302.3.](#)

1303.4 Copper or copper-alloy pipe. Joints between copper or copper-alloy pipe or fittings shall be brazed, mechanical, threaded, [press-connect](#) or welded joints complying with Section 1303.3.

2021 Virginia Fuel Gas Code (VFGC)

202 Definitions – Service Meter Assembly, Service Shutoff, and System Shutoff

Change Type: 2 Additions, 1 Modification

- New definitions clarify terms that are used in the definition of “point of delivery” (next page) and a change to the definition of “service shutoff” coordinates with all relative definitions.

Service Meter Assembly

The meter, valve, regulator, piping, fittings and equipment installed by the service gas supplier before the point of delivery

Service Shutoff

A valve, installed by the serving gas supplier between ~~service meter or~~ the source of supply and the point of delivery ~~customer piping system~~, to shut off the entire piping system.

System Shutoff

A valve installed after the point of delivery to shut off the entire piping system.

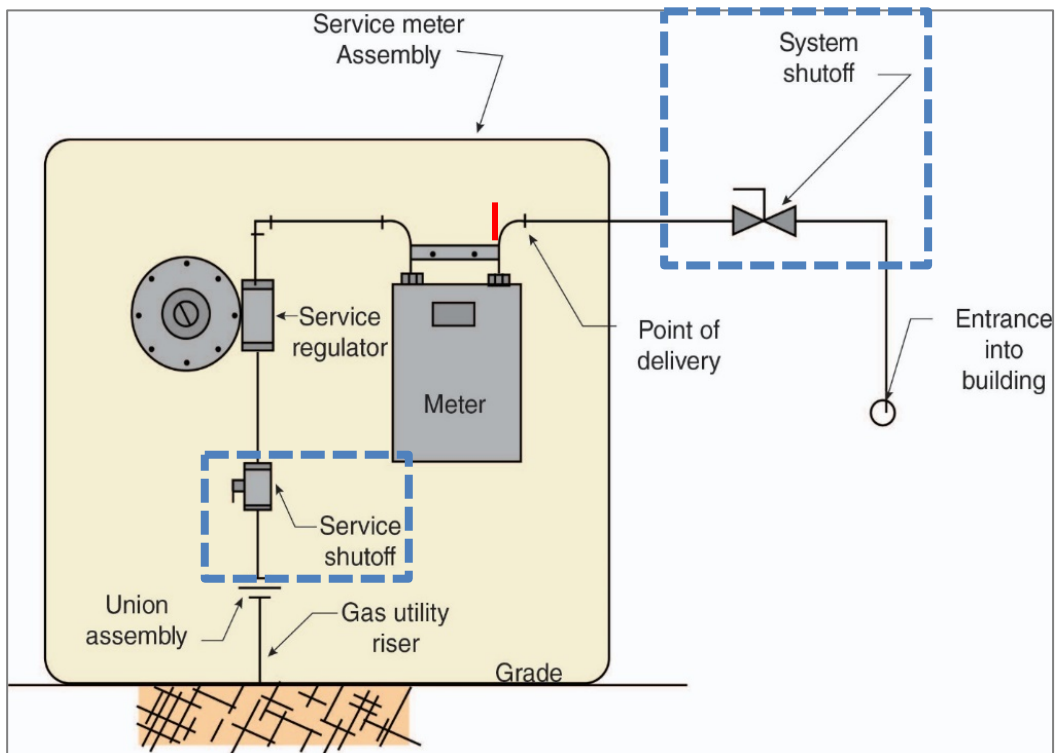

202 Definitions – Point of Delivery

Change Type: Modification

POINT OF DELIVERY.
For natural gas systems, the point of delivery is the outlet of the service meter assembly or the outlet of the service regulator or service shutoff valve where a meter is not provided. Where a **system shutoff** valve is provided **at after** the outlet of the service meter assembly, such valve shall be considered to be downstream of the point of delivery. For undiluted liquefied petroleum gas systems, the point of delivery shall be considered to be the outlet of the service pressure regulator, exclusive of line gas regulators, in the system.

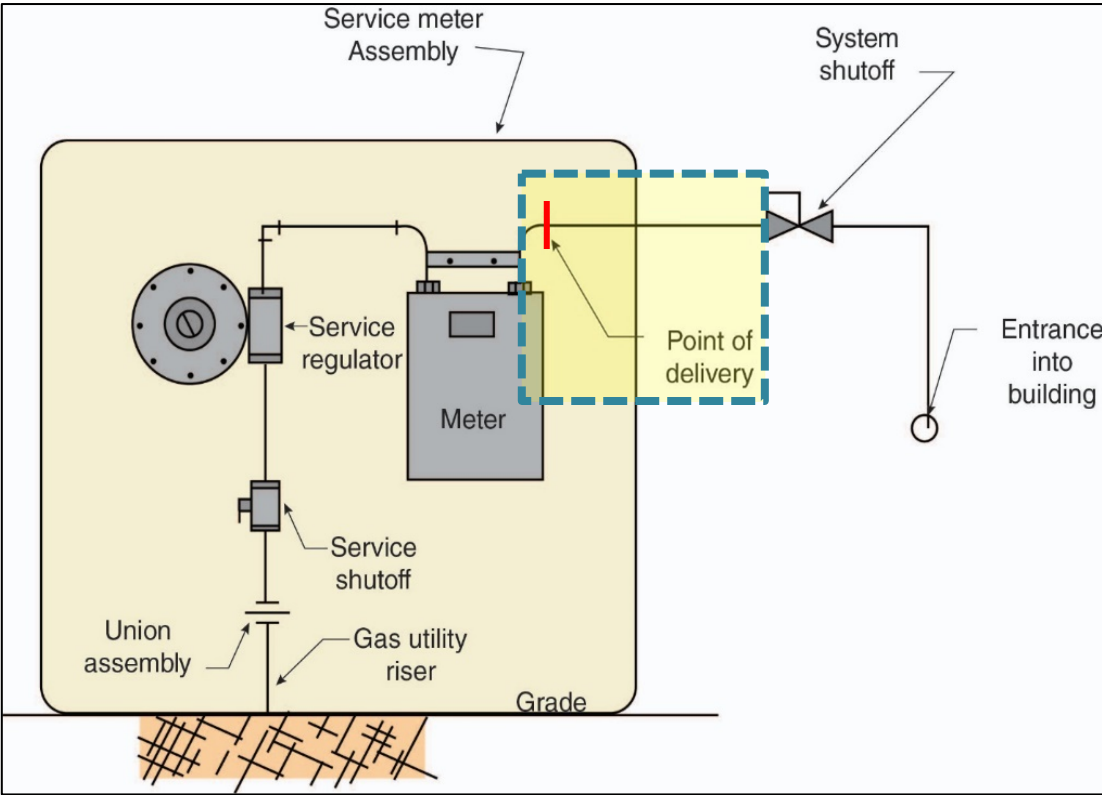

307.2 Fuel-Burning Appliances (Concealed Condensate Piping)

- **Change Type:** Modification
- This change mirrors the change we reviewed previously in the Mechanical section (307.1.1, 307.2.3.3 Identification) for concealed condensate piping.

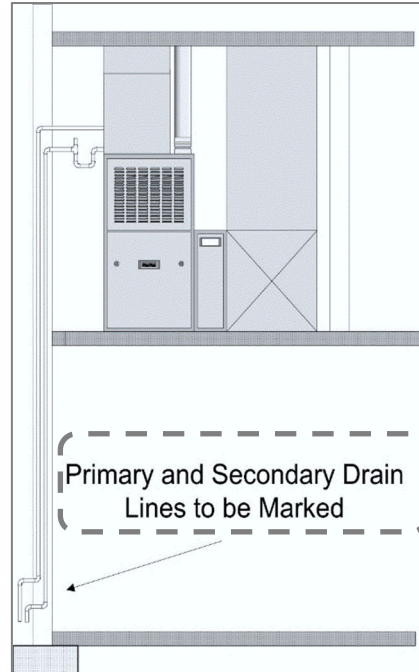

307.2 Fuel-burning appliances. Liquid combustion byproducts of condensing appliances shall be collected and discharged to an approved plumbing fixture or disposal area in accordance with the manufacturer's instructions. Condensate piping shall be of approved corrosion-resistant material and shall be not smaller than the drain connection on the appliance. Such piping shall maintain a minimum slope in the direction of discharge of not less than $\frac{1}{8}$ unit vertical in 12 units horizontal (1-percent slope). **The termination of concealed condensate piping shall be marked to indicate whether the piping is connected to the primary drain or to the secondary drain.**

402.7, 202 Maximum Operating Pressure (Press-Connect Joint)

Change Type: Addition

- The code now recognizes press-connect joints as suitable for high pressure (over 5 psig) applications indoors and the definition is added to the VFGC/IFGC.

PRESS-CONNECT JOINT

A permanent mechanical joint incorporating an elastomeric seal or an elastomeric seal and corrosion-resistant grip or bite ring. The joint is made with a pressing tool and jaw or ring approved by the fitting manufacturer.

402.7 Maximum operating pressure. The maximum operating pressure for piping systems located inside buildings shall not exceed 5 pounds per square inch gauge (psig) (34 kPa gauge) except where one or more of the following conditions are met:

2. The piping is joined by fittings listed to ANSI LC-4/CSA 6.32 and installed in accordance with the manufacturer's instructions.

(Items 1, and 3 through 8 are unchanged)

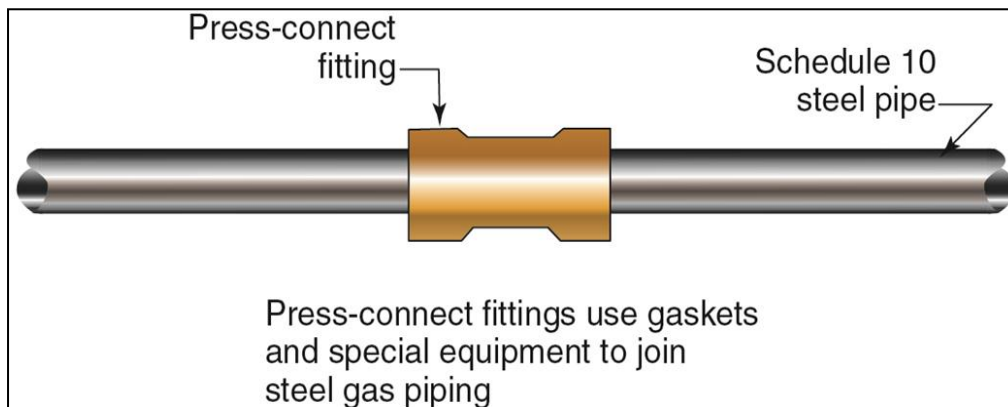

403.8.3 Threaded Joint Sealing

Change Type: Modification

- Text was revised to require the use of thread joint sealants (aka joint compounds, pipe dope, pipe tape).
- Thread sealants act primarily as a lubricant to allow the threads to form a tight metal-to-metal seal and any imperfections or voids in the threads are filled in by the thread sealant material.
- The most common thread sealants used today are pastes made with PTFE (Teflon) and Teflon tapes.



403.8.3 Threaded joint sealing. Threaded joints shall be made using a thread joint sealing material. Thread joint sealing materials shall be nonhardening and shall be resistant to the chemical constituents of the gases to be conducted through the piping. Thread joint sealing materials shall be compatible with the pipe and fitting materials on which the sealing materials are used.

404.5 Fittings in Concealed Locations

Change Type: Clarification

- This change addresses an omission of threaded fittings that were intended to be allowed in concealed locations, yet not specifically mentioned in the text.

404.5 Fittings in concealed locations. Fittings installed in concealed locations shall be limited to the following types:

1. Threaded elbows, tees, couplings, [plugs and caps](#).
2. Brazed fittings.
3. Welded fittings.
4. Fittings listed to ANSI LC-1/CSA 6.26 or ANSI LC-4/CSA 6.32.

410.2 MP Regulators

Change Type: Clarification

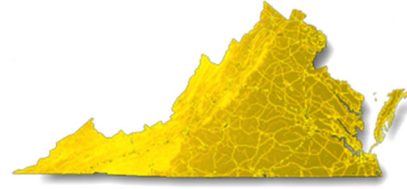

- This amendment expands the list of acceptable pressure test ports by recognizing that regulator, appliance gas control, and pre-fabricated manifold manufacturers provide integral test ports in their devices that meet the intent of the code
- Existing item #6 is modified as shown below (other items in this section are unchanged)
- VA Proposal M410.2-21

~~6. A tee fitting with one opening capped or plugged shall be installed not less than 10 pipe diameters downstream of the MP regulator outlet. Such tee fitting shall be positioned to allow connection of a pressure measuring instrument. The tee fitting is not required where the MP regulator serves an appliance that has a pressure test port on the gas control inlet side and the appliance is located in the same room as the MP regulator.~~
Means shall be provided downstream of the MP regulator for the connection of a pressure measuring instrument and shall be positioned to allow connection of a pressure measuring instrument. Such means shall be permitted to be a dedicated test port on a regulator, gas control, or manifold, or a plugged tee fitting or plugged manifold port.

503.8 Venting System Terminal Clearances

Change Type: Modification (however the reorganization of this section is not meant to make any technical changes to the though-the-wall vent terminal clearance provisions.)

- Though the wall vent terminal clearance distances have been placed in a new table for ease of use (Table 503.8 Through-the-Wall Vent Terminal Clearances)
- New figure 503.8 has been added which illustrates the “Figure Clearance” location referenced in the table.

503.8 Venting system termination location terminal clearances. The clearances for through-the-wall direct-vent and non-direct-vent terminals shall be in accordance with Table 503.8 and Figure 503.8.

Exception: The clearances in Table 503.8 shall not apply to the combustion air intake of a direct-vent appliance

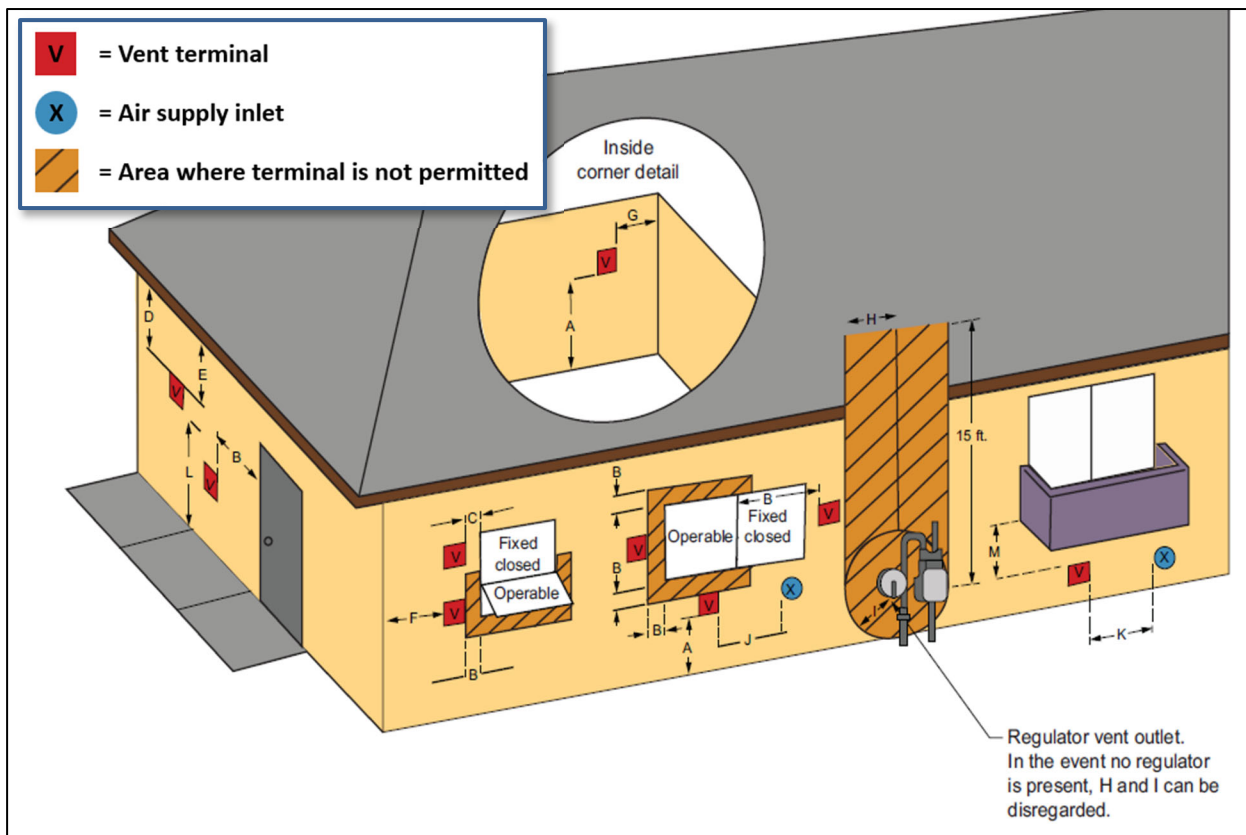

Table 503.8 - Venting System Terminal Clearances

Figure	Clearance Location	Minimum Clearance for Direct-Vent Terminals	Minimum Clearances for Non-Direct Vent Terminals
A	Clearance above finished grade level, veranda, porch, deck, or balcony	12 inches	
B	Clearance to window or door that is openable	<ul style="list-style-type: none"> ▪ 6" - appliances less than 10K Btu/hr ▪ 9" - appliances 10K up to 50K Btu/hr) ▪ 12" -appliances 50K up to 150K Btu/hr <p>Appliances 150K Btu/hr, or more in accordance with the appliance manufacturer's instructions and not less than the clearances specified for Non-Direct Vent Terminals in row B</p>	4 ft. below or to side of opening or 1 foot above opening
C	Clearance to non-openable window	None unless otherwise specified by the appliance manufacturer	
D	Vertical clearance to ventilated soffit located above the terminal within a horizontal distance of 2' from the center line of the terminal	None unless otherwise specified by the appliance manufacturer	
E	Clearance to unventilated soffit	None unless otherwise specified by the appliance manufacturer	
F	Clearance to outside corner of building	None unless otherwise specified by the appliance manufacturer	
G	Clearance to inside corner of building	None unless otherwise specified by the appliance manufacturer	
H	Clearance to each side of center line extended above regulator vent outlet	3 ft. up to a height of 15 ft. above the regulator vent outlet	
I	Clearance to service regulator vent outlet in all directions	3 ft. for gas pressures up to 2 psi 10 ft. for gas pressures above 2 psi	
J	Clearance to non-mechanical air supply inlet to building and the combustion air inlet to any other appliance	Same clearance as specified for row B	
K	Clearance to a mechanical air supply inlet	10 ft. horizontally from inlet or 3 ft. above inlet	
L	Clearance above paved sidewalk or paved driveway located on public property	7 ft. and shall not be located above public walkways or other areas where condensate or vapor can cause a nuisance or hazard	
M	Clearance to underside of veranda, porch deck, or balcony	12 in. where the area beneath the veranda, porch deck or balcony is open on not less than two sides. The vent terminal is prohibited in this location where only one side is open.	

503.10.7 Vent Connector Junctions

Change Type: Addition

- New text addresses the juncture of appliance vent connectors and the required method.

503.10.7 Connector junctions. Where vent connectors are joined together, the connection shall be made with a tee or wye fitting.

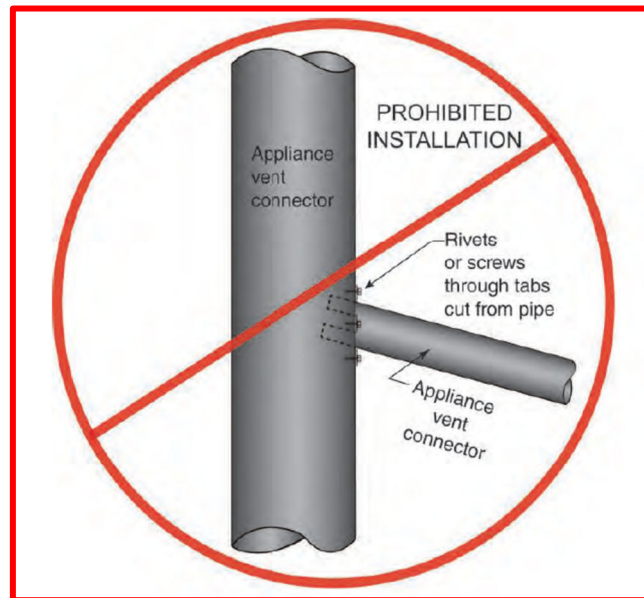
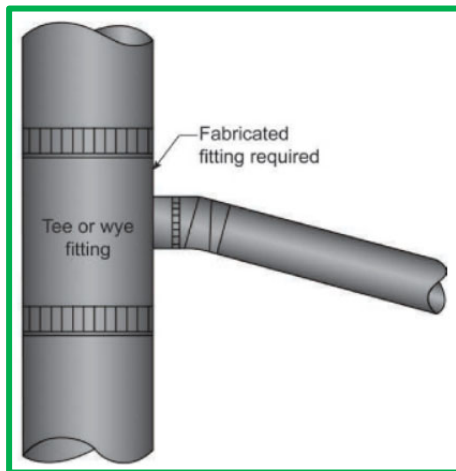

618.6 Furnace Plenums and Air Ducts

Change Type: Modification

618.6 Furnace plenums and air ducts. Where a furnace is installed so that supply ducts carry air circulated by the furnace to areas outside of the space containing the furnace, the return air shall be handled by a duct(s) sealed to the furnace casing and terminating outside of the space containing the furnace. **Return air shall not be taken from the mechanical room containing the furnace.**

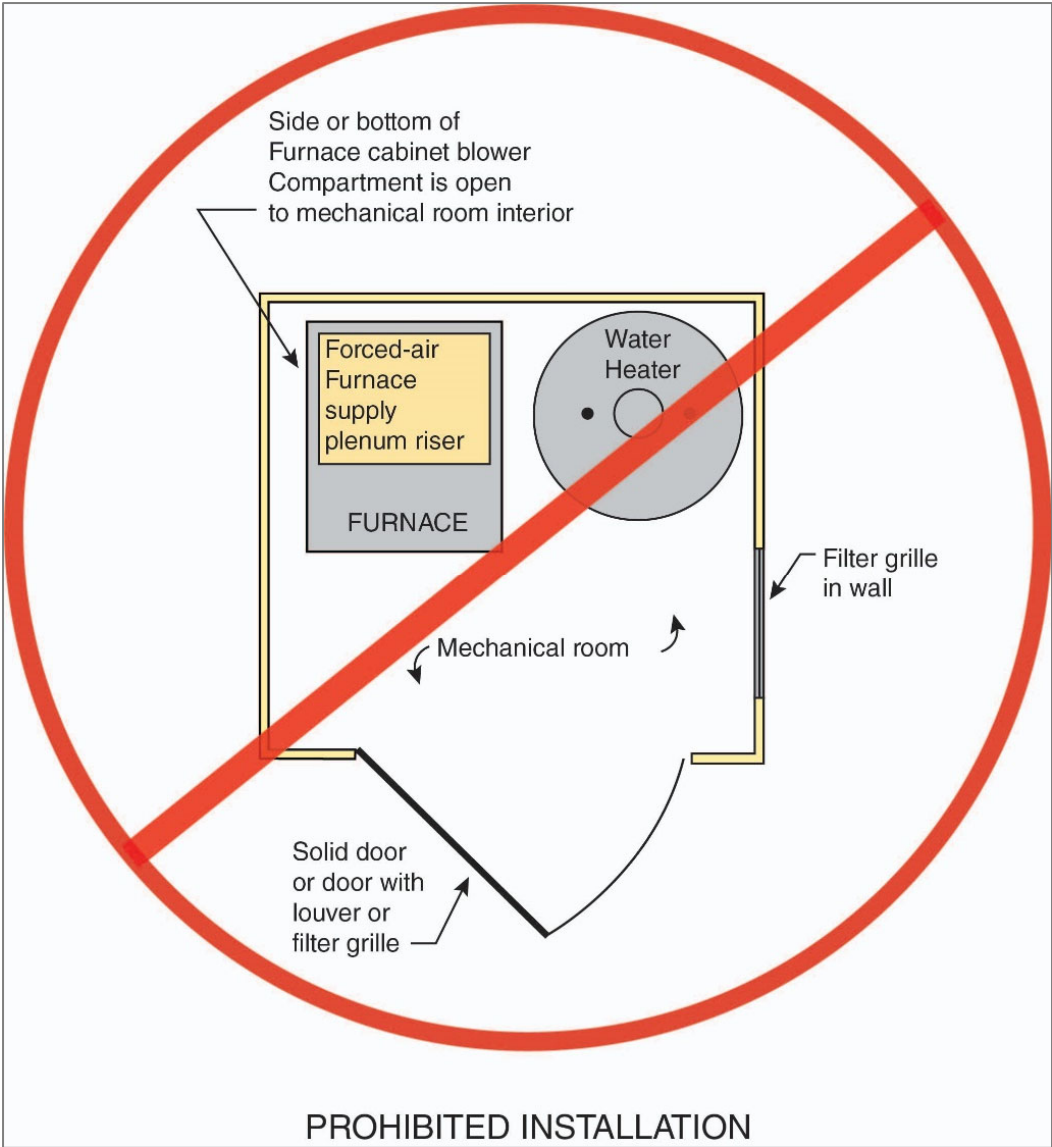

623.2 Prohibited Location (Commercial Cooking Appliances)

Change Type: Modification

- Exception #2 for commercial cooking appliances within dwelling units has been deleted.



623.2 Prohibited location. Cooking appliances designed, tested, listed and labeled for use in commercial occupancies shall not be installed within dwelling units or within any area where domestic cooking operations occur.

Exceptions:

1. Appliances that are also listed as domestic cooking appliances.

~~2. Where the installation is designed by a licensed Professional Engineer, in compliance with the manufacturer's installation instructions.~~

Glossary

This glossary provides a convenient list of some common terms that are either new to the code or discussed along with these changes. Note that this glossary is not intended to be a complete list of terms and definitions. (See the appropriate code book for full definitions)

Accessible (as applied to equipment) - (National Electric Code)

Capable of being reached for operation, renewal, and inspection. (CMP-1)

Atrium (Virginia Construction Code)

A vertical space that is closed at the top, connecting two or more stories in Group I-2 and I-3 occupancies or three or more stories in all other occupancies.

Available Fault Current (National Electric Code)

The largest amount of current capable of being delivered at a point on the system during a short-circuit condition. (CMP-10)

Informational Note: A short-circuit can occur during abnormal conditions such as a fault between circuit conductors or a ground fault. See Informational Note Figure 100.1.

Balanced Ventilation (Virginia Residential Code, Virginia Mechanical Code)

Any combination of concurrently operating mechanical exhaust and mechanical supply whereby the total mechanical exhaust airflow rate is within 10% of the total mechanical supply airflow rate.

Base Flood Elevation (Virginia Construction Code)

The elevation of the base flood, including wave height, relative to the National Geodetic Vertical Datum (NGVD), North American Vertical Datum (NAVD) or other datum specified on the Flood Insurance Rate Map (FIRM), and as shown in the Flood Insurance Study.

Biogas (Virginia Energy Conservation Code[CE])

A mixture of hydrocarbons that is a gas at 60°F (15.5°C) and 1 atmosphere of pressure that is produced through the anaerobic digestion of organic matter.

Biomass (Virginia Energy Conservation Code[CE])

Nonfossilized and biodegradable organic material originating from plants, animals and/or microorganisms, including products, by-products, residues and waste from agriculture, forestry and related industries as well as the nonfossilized and biodegradable organic fractions of industrial and municipal wastes, including gases and liquids recovered from the decomposition of nonfossilized and biodegradable organic material.

Building (Virginia Residential Code)

Any one- or two-family dwelling or townhouse, or portion thereof, used or intended to be used for human habitation, for living, sleeping, cooking or eating purposes, or any combination thereof, or any accessory structure. For the definition applicable in Chapter 11, see Section N1101.6.

Change Of Occupancy (Virginia Existing Building Code)

Either of the following shall be considered a change of occupancy where the current VCC requires a greater degree of structural strength, fire protection, means of egress, ventilation or sanitation than is existing in the current building or structure:

1. Any change in the occupancy classification of a building or structure.
2. Any change in the purpose of, or a change in the level of activity within, a building or structure.

Note: The use and occupancy classification of a building or structure, shall be determined in accordance with Chapter 3 of the VCC.

Coastal High Hazard Area (Virginia Construction Code)

Area within the special flood hazard area extending from offshore to the inland limit of a Coastal Primary Sand Dune, as defined by state code (Code of Virginia Title 28.2), along an open coast and any other area that is subject to high velocity wave action from storms or seismic sources, and shown in either the Flood Insurance Study, or on a the Flood Insurance Rate Map (FIRM) or other flood hazard map as velocity Zone V, VO, VE or V1-30 (areas subject to wave heights of 3 feet (914.4 mm) or more).

Copper Alloy (Virginia Plumbing Code)

A metal alloy where the principle component is copper.

Dormitory Unit (National Electric Code)

A building or a space in a building in which group sleeping accommodations are provided for more than 16 persons who are not members of the same family in one room, or a series of closely associated rooms, under joint occupancy and single management, with or without meals, but without individual cooking facilities. (CMP 2)

Emergency Escape and Rescue Opening. (Virginia Residential Code)

An operable exterior window, door or other similar device that provides for a means of escape and access for rescue in the event of an emergency. (See also “Grade floor emergency escape and rescue opening.”)

Equipotential Plane (National Electric Code)

Accessible conductive parts bonded together to reduce voltage gradients in a designated area. (CMP-17)

Fan Array (Virginia Energy Conservation Code[CE])

Multiple fans in parallel between two plenum sections in an air distribution system.

Fan Energy Index (FEI) (Virginia Energy Conservation Code[CE])

The ratio of the electric input power of a reference fan to the electric input power of the actual fan as calculated in accordance with AMCA 208.

Fan Nameplate Electrical Input Power (Virginia Energy Conservation Code[CE])

The nominal electrical input power rating stamped on a fan assembly nameplate.

Fan System Electrical Input Power (Virginia Energy Conservation Code[CE])

The sum of the fan electrical power of all fans that are required to operate at fan system design conditions to supply air from the heating or cooling source to the conditioned spaces and/or return it to the source or exhaust it to the outdoors.

Fan, Embedded (Virginia Energy Conservation Code[CE])

A fan that is part of a manufactured assembly where the assembly includes functions other than air movement.

Fault Current (National Electric Code)

The current delivered at a point on the system during a short-circuit condition. (CMP-10)

Flood Hazard Area (Uniform Statewide Building Code)

The greater of the following two areas:

1. The area within a flood plain subject to a 1-percent or greater chance of flooding in any year (also known as the 100-year floodplain).
2. The area designated as a flood hazard area on a community's flood hazard map, or otherwise legally designated, including areas in either the Flood Insurance Study or on the Flood Insurance Rate Map (FIRM) and including areas added to account for future flooding conditions based on the locally adopted sea level rise projected to occur by 2070.

Flood Or Flooding (Virginia Construction Code)

1. The overflow of inland or tidal waves A general and temporary condition of partial or complete inundation of normally dry land from either of the following:
 - 1.1 The overflow of inland or tidal waves
 - 1.2 The unusual and rapid accumulation or runoff of surface waters from any source.
2. The collapse or subsidence of land along the shore of a lake or other body of water as a result of erosion or undermining caused by waves or currents of water exceeding anticipated cyclical levels or suddenly caused by an unusually high water level in a natural body of water, accompanied by a severe storm, or by an unanticipated force of nature such as flash flood or an abnormal tidal surge, or by some similarly unusual and unforeseeable event which results in flooding as defined in subsection (1.1) of this definition.
3. Mudflows which are proximately caused by flooding as defined in subsection (1.2) of this definition and are akin to a river of liquid and flowing mud on the surface of normally dry land areas, as when earth is carried by a current of water and disposed along the path of the current.

Free Air (As Applied to Conductors) (National Electric Code)

Open or ventilated environment that allows for heat dissipation and air flow around an installed conductor. (CMP-6)

Grade Floor Emergency Escape and Rescue Opening (Virginia Residential Code)

An emergency escape and rescue opening located such that the bottom of the clear opening is not more than 44 inches (1118 mm) above or below the finished ground level adjacent to the opening. (See also "Emergency escape and rescue opening.")

Habitable Room (National Electric Code)

A room in a building for living, sleeping, eating, or cooking, but excluding bathrooms, toilet rooms, closets, hallways, storage or utility spaces, and similar areas. (CMP-2)

Intermodal Shipping Containers (Virginia Construction Code)

A six-sided steel unit originally constructed as a general cargo container used for the transport of goods and materials.

Island Mode (National Electric Code)

The operational mode for standalone power production equipment or an isolated microgrid, or for a multimode inverter or an interconnected microgrid that is disconnected from an electric power production and distribution network or other primary power source. (CMP-4)

Informational Note: Isolated microgrids are distinguished from interconnected microgrids, which are addressed in Article 705.

Penthouse (Virginia Construction Code)

An enclosed, unoccupied rooftop structure used for sheltering mechanical and electrical equipment, tanks, elevators and related machinery, stairways, and vertical shaft openings.

Point Of Delivery (Virginia Residential Code, Virginia Fuel Gas Code)

For natural gas systems, the point of delivery is the outlet of the service meter assembly or the outlet of the service regulator or service shutoff valve where a meter is not provided. Where a system shutoff valve is provided at after the outlet of the service meter assembly, such valve shall be considered to be downstream of the point of delivery. For undiluted liquefied petroleum gas systems, the point of delivery shall be considered to be the outlet of the service pressure regulator, exclusive of line gas regulators, in the system.

Press-Connect Joint (Virginia Fuel Gas Code)

A permanent mechanical joint incorporating an elastomeric seal or an elastomeric seal and corrosion-resistant grip or bite ring. The joint is made with a pressing tool and jaw or ring approved by the fitting manufacturer.

Private (Virginia Plumbing Code)

In the classification of plumbing fixtures, “private” applies to fixtures that are not public

Public Or Public Utilization (Virginia Plumbing Code)

In the classification of plumbing fixtures, “public” applies to fixtures with unrestricted exposure to walk-in traffic

Puzzle Room (Virginia Construction Code)

A puzzle room is a type of special amusement area in which occupants are encouraged to solve a challenge to escape from a room or series of rooms.

Reconditioned (National Electric Code)

Electromechanical systems, equipment, apparatus, or components that are restored to operating conditions. This process differs from normal servicing of equipment that remains within a facility, or replacement of listed equipment on a one-to-one basis.
(CMP-10)

Informational Note: The term reconditioned is frequently referred to as rebuilt, refurbished, or remanufactured.

Secondary Structural Members (Virginia Construction Code)

The following structural members shall be considered secondary members and not part of the primary structural frame:

1. Structural members not having direct connections to the columns.
2. Members of the floor construction and roof construction not having direct connections to the columns.
3. Bracing members that are not designated as part of a primary structural frame or bearing wall.

Service Meter Assembly (Virginia Residential Code, Virginia Fuel Gas Code)

The meter, valve, regulator, piping, fittings and equipment installed by the service gas supplier before the point of delivery.

Service Shutoff (Virginia Residential Code, Virginia Fuel Gas Code)

A valve, installed by the serving gas supplier between the service meter or source of supply and the customer piping system point of delivery, to shut off the entire piping system.

Special Event Structure (Virginia Construction Code)

Any ground-supported structure, platform, stage, stage scaffolding or rigging, canopy, tower or similar structure supporting entertainment-related equipment or signage.

Special Flood Hazard Area (Virginia Construction Code)

The land area subject to flood hazards and shown on a Flood Insurance Rate Map the Flood Insurance Study as Zone A, AE, A1-30, A99, AR, AO, AH, V, VO, VE or V1-30.

Storm Shelter (Virginia Residential Code)

A building, structure or portion thereof, constructed in accordance with ICC 500 and designated for use during a severe windstorm event, such as a hurricane or tornado.

Supply-Side Bonding Jumper (National Electric Code)

Swimout (International Swimming Pool and Spa Code)

An underwater seat area that is placed completely outside of the diving envelope of the pool. Where located at the deep end, swimouts are permitted to be used as the deep-end means of entry or exit to the pool.

System Shutoff (Virginia Residential Code, Virginia Fuel Gas Code)

A valve installed after the point of delivery to shut off the entire piping system.

Townhouse (Virginia Residential Code)

Building that contains three or more attached townhouse units.

Townhouse Unit (Virginia Residential Code)

A single-family dwelling unit in a townhouse that extends from foundation

Unfit For Human Occupancy (Virginia Property Maintenance Code)

DELETED (see *Unsafe Structure*)

Unsafe Structure (Virginia Property Maintenance Code)

An existing structure determined by the code official to be dangerous to the health, safety and welfare of the occupants of the structure or the public because of, but not limited to, any of the following conditions:

1. The structure contains *unsafe equipment*;
2. The structure is so damaged, decayed, dilapidated, structurally unsafe or of such faulty construction or unstable foundation that partial or complete collapse is likely;
3. The structure is unsecured or open ;
4. The degree to which the structure is in disrepair or lacks maintenance, ventilation, illumination, sanitary or heating facilities or other essential equipment;
5. The required plumbing and sanitary facilities are inoperable.

Unvented Alcohol Fuel Burning Decorative Appliance (Virginia Mechanical Code)

A stationary, self-contained appliance intended to be directly or indirectly secured to a wall or floor and not intended for duct connection. Such appliance burns alcohol and is made in a manufacturing facility for subsequent delivery to the installation site.

Water Dispenser (Virginia Plumbing Code)

A plumbing fixture that is manually controlled by the user for the purpose of dispensing potable drinking water into a receptacle such as a cup, glass or bottle. Such fixture is connected to the potable water distribution system of the premises



Virginia Department of Housing & Community Development
Jack A. Proctor Virginia Building Code Academy
600 East Main Street Suite 1100
Richmond VA 23219
Phone (804) 371-7180
Website: www.dhcd.virginia.gov
Email: vbca@dhcd.virginia.gov

21CCT_r10_2023.1